

LIVING now



TRADITIONAL
CONTROL



CONTROL WITH
SMARTPHONE



VOICE
COMMAND



PLANNING
PROGRAMMED

bticino

CONTENTS

DESIGN

DESIGN INNOVATION	6
NEW DIGITAL CONTROLS WITH LIVING NOW FINISH	8
FINISHING	10

THE SOLUTION FOR ALL SYSTEM REQUIREMENT	18
--	----

LIVING NOW WITH NETATMO

SMART ELECTRICAL SYSTEM	20
HOME+CONTROL APP	24
MANAGE THE HOME ALSO WITH THE VOICE	26
SMART DEVICES RANGE	28
INSTALLATION	30
THE NEW CONNECTED THERMOSTAT SMARTHER	32

LIVING NOW MYHOME_UP

INSTALL THE MYHOME_UP SYSTEM USING THE LIVING NOW RANGE	34
NEW DIGITAL AND VOICE CONTROL	36
INSTALLATION OF DIGITAL CONTROLS	42

ALWAYS PERFECT INSTALLATION	44
------------------------------------	----

AN INTERNATIONAL STANDARD	48
----------------------------------	----

CATALOGUE	50
------------------	----

LIVING now



Forever an icon,
today Smart as well.

Living Now is the new Living generation. A timeless icon which combines the linearity of a unique design with the simplicity of Smart technology. All this without changing usual wiring procedures because Living Now is always installed in the traditional way, guaranteeing a perfect installation.



Traditional
control



Control with
smartphone



Voice
command



Planning
programmed

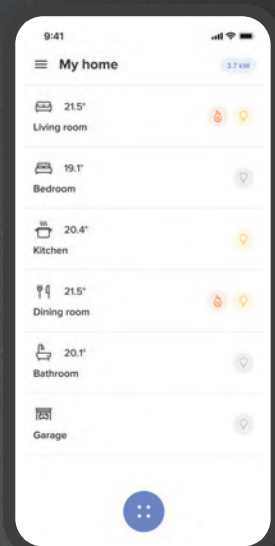

- **Innovative design:** revisited relationship between cover plate and functions.
- **Smart:** the first intrinsically connected wiring devices range!
- The best technical solutions for a **perfect installation.**

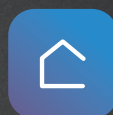
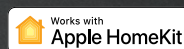

App
Home + Control



DESIGN INNOVATION

**PERFECT PLANARITY AND
ELEGANT DETAILS**



Living Now, has won this prestigious international award confirming BTicino's ability to combine technology and design.



The international jury at the XXVI Compasso d'Oro ADI Award 2020, granted Living Now an Honourable Mention. The Compasso d'Oro ADI Award is the oldest and most authoritative international design award.

FULL TOUCH CONTROLS

The light can be switched on or off by pressing any point of the surface of the keys. After being pressed, the keys return to their original position, perfectly aligned.

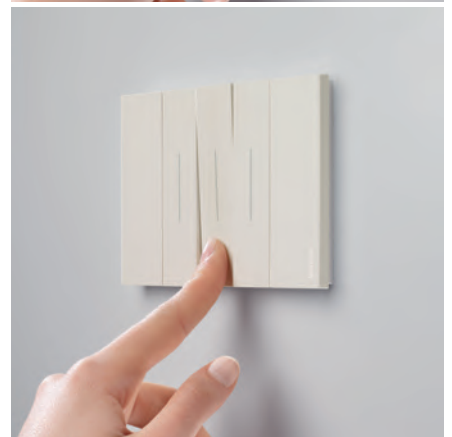

MORE SPACE FOR FUNCTIONS

Unique shape with space increased for functions.

NEW DIGITAL CONTROLS WITH LIVING NOW FINISH

Living Now series digital controls are now part of the MyHOME_Up home automation range. A mix of incomparable innovation and simplicity, ready to be discovered, heard and touched.





LIGHT AND FULL CONTROLS

- New touch controls without cover plate
- Customised icons and leds using the app MyHOME_Up
- Expandable to new functions

DEVICE FINISHING

WHITE



SAND



BLACK

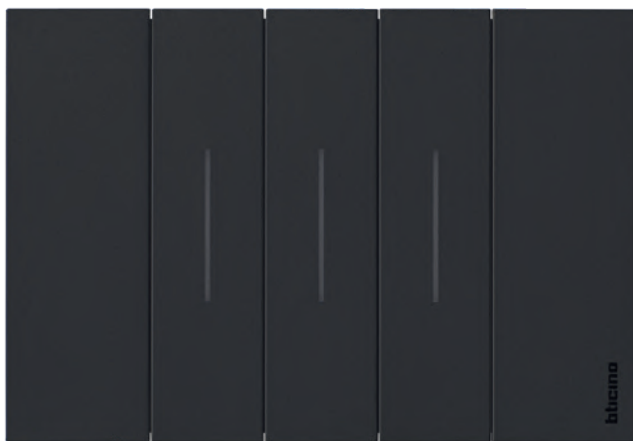

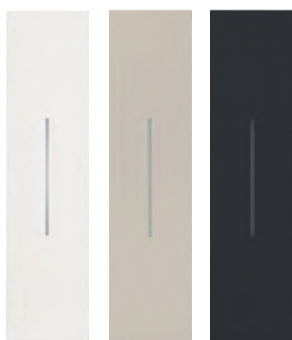

3 COLOURS FOR THE DEVICES

The devices feature an aesthetic component, the covers, available in three different colours: white, sand and black. Satin finish surface: for a pleasant feel.

COMBINATION WITH THE COVER PLATES

The Living Now cover plate range includes 16 finishes, purposely selected for use with the device covers, and made of different materials: techno polymer, metal and wood.



COORDINATION OF APPEARANCE OF THE MYHOME_UP DIGITAL CONTROLS

MyHOME_Up digital controls do not require the use of cover plates and are available in white, sand and black.



COVER PLATE FINISHING



ICE cover plate
Material: techno polymer
Code: ...DW





The zamak and wood finishes are obtained using non-mass production procedures. The individual differences among the various cover plates are therefore a distinguishing valuable element.



WHITE cover plate
Material: techno polymer
Code: ...KW



GOLD cover plate
Material: zamak
Code: ...ZW



MOON COVER PLATE
Material: zamak
Code: ...NW



SKY cover plate
Material: techno polymer
Code: ...DA



PIXEL cover plate
Material: techno polymer
- pixel effect
Code: ...MW

COVER PLATE FINISHING

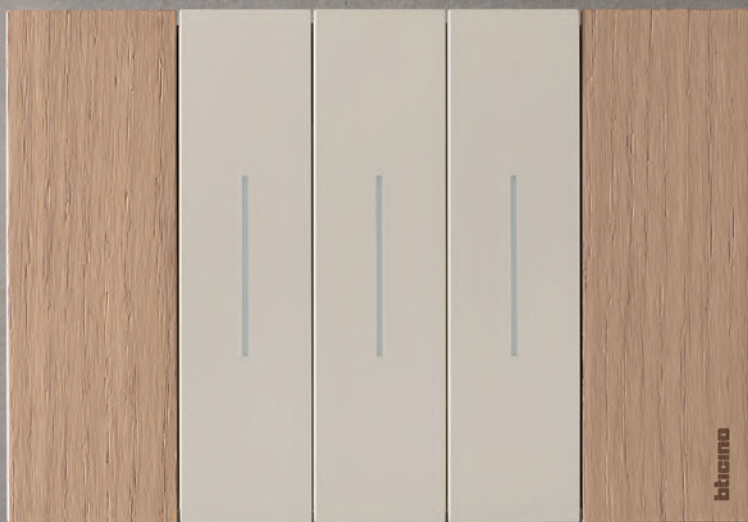

OAK cover plate
Material: wood
Code: ...LM





The zamak and wood finishes are obtained using non-mass production procedures. The individual differences among the various cover plates are therefore a distinguishing valuable element.



SAND cover plate
Material: techno polymer
Code: ...KM



COPPER cover plate
Material: zamak
Code: ...ZM



AURA cover plate
Material: techno polymer
Code: ...DM



OPTIC cover plate
Material: techno polymer
- pixel effect
Code: ...MM

COVER PLATE FINISHING



STEEL cover plate
Material: zamak
Code: ...ZG





The zamak and wood finishes are obtained using non-mass production procedures. The individual differences among the various cover plates are therefore a distinguishing valuable element.



BLACK cover plate

Material: techno polymer
Code: ...KG



SPACE cover plate

Material: zamak
Code: ...NG



WALNUT cover plate

Material: wood
Code: ...LG



NIGHT cover plate

Material: techno polymer
Code: ...DG

THE RIGHT SOLUTION FOR ALL NEEDS

SMART ELECTRICAL SYSTEM

Living Now ^{WITH} Netatmo

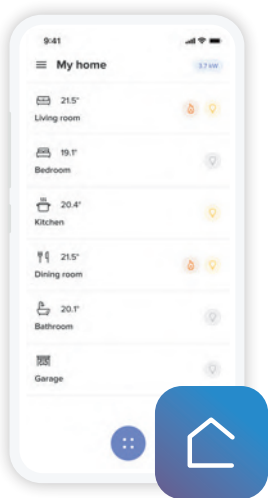
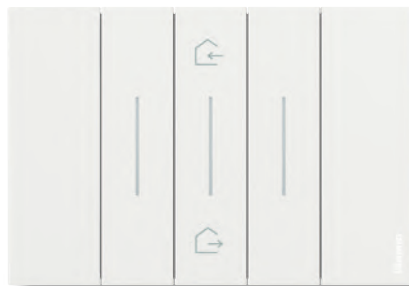
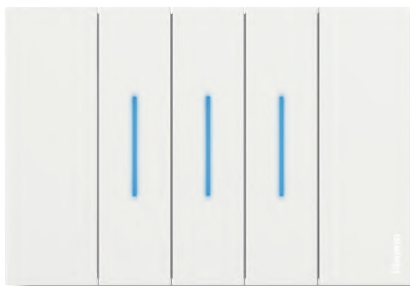

App HOME + CONTROL

INSTALLATION WITH TRADITIONAL WIRING

Install a traditional electric system and add the SMART functions connected to the home Wi-Fi network, controlled using the HOME + CONTROL App.

FUNCTIONS

- Lights
- Shutters
- Sockets
- Temperature control
- Scenario control
- Consumption display
- Load anti-blackout control
- Planning programmed

CHOOSE HOW TO CONTROL IT

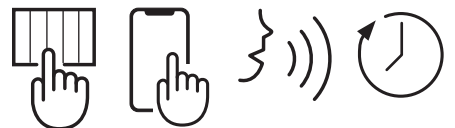

LIVING
now

HOME AUTOMATION SYSTEM

Living Now MyHOME_Up

alexia built-in

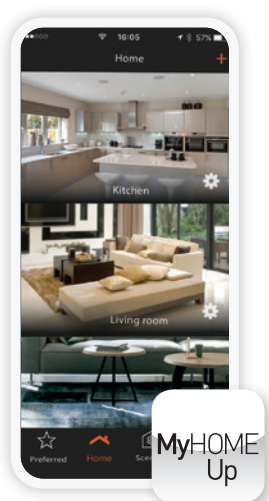

App MyHOME_Up

INSTALLATION WITH BUS

Create a BUS integrated system manageable from the MyHOME_UP App, using your voice or the Touch Screen controls.

FUNCTIONS

- Lights
- Shutters
- Sockets
- Temperature control
- Scenario control
- Consumption display
- Load anti-blackout control
- Video door entry system
- NUVO sound diffusion system
- Integration with other brand.

CHOOSE HOW TO CONTROL IT



SMART ELECTRICAL SYSTEM

Check your home just like your e-mail or your bank account. Starting from today, you will have all this at your fingertips, in full safety and easily.

App
HOME + CONTROL

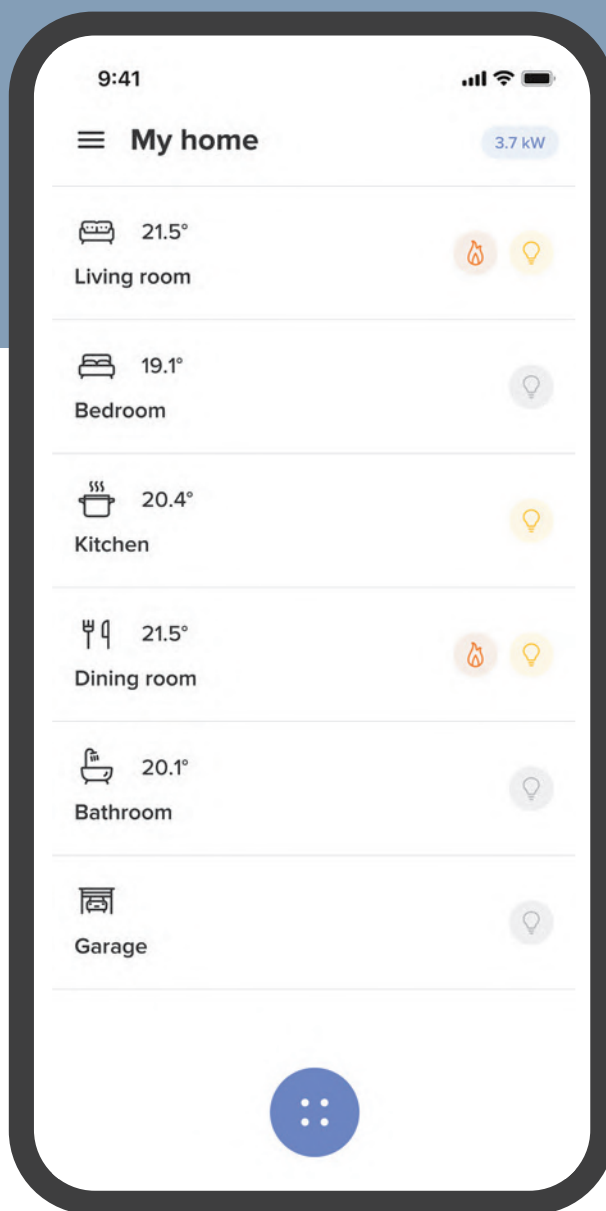

GENERAL CONTROL

With one single click, a general control will allow you to switch off all the lights and lower all the shutters when you leave your home, or to activate your favourite scenario.



CONTROL WITH SMARTPHONE

From your smartphone, you will be able to view and check the status of lights, shutters and connected power sockets from anywhere.



VOICE COMMAND

You can control your system with your voice thanks to your favourite voice assistant.

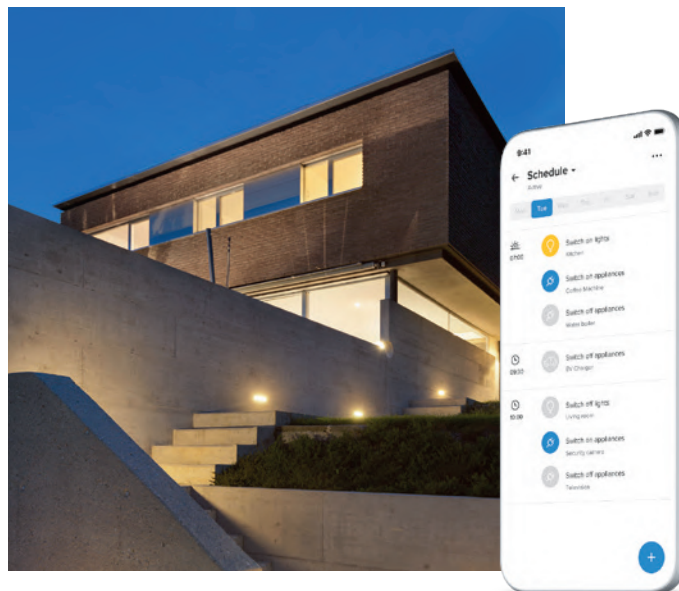
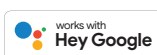

PLANNED PROGRAMMING

Program the activation of lights, shutters and loads connected to sockets based on your needs. Some examples:

- automatically switch on the garden lights at sunset and switch them off at sunrise;
- switch on some lights and activate some shutters to simulate the presence of someone in the house when on holidays.

Smart electric system

MANAGEMENT OF THE TEMPERATURE

Remotely check and manage the temperature inside your home using your smartphone and installing the connected thermostat Smarter with Netatmo.



LIGHTING AT THE DESIRED LEVEL

Adjust the light level for optimum personal comfort. You can do that from the connected Dimmer, the associated wireless controls and the Smartphone, using the Home+Control App.

LOAD CONTROL TO AVOID BLACKOUTS (*)

In overload conditions, the system automatically disconnects the least important load to avoid tripping of the meter (blackout).



ENERGY CONSUMPTION CONTROL

Use your smartphone to check the electricity consumption of your appliances (daily, monthly and yearly).



WIRELESS CONTROL

You can add wireless controls (lights, shutters and sockets), or reposition them at any time depending on your needs.



ALARM NOTIFICATIONS

You can receive warning notifications on your smartphone.

Note (*): function available by Autumn 2020.

HOME + CONTROL

One single App, many connected advantages



Home+Control is the App that makes it simple to supervise all the Living Now Smart system functions using iOS and Android mobile devices, inside and outside the home.

The Homepage shows all the system information.



WHAT YOUR CUSTOMER CAN DO:

1. Activate and customise **8 scenarios** (4 preconfigured scenarios, coming in, going out, day, night and 4 scenarios customisable by the user);
2. **Display and check the status of lights, shutters, loads connected to sockets and the room temperature;**
3. **Use the Smarter timer thermostat** simply and intuitively;
4. **Check the total home consumptions.**
5. **Receive notifications** on the load and system status;
6. **Define the load priority** for black-out prevention (function available by Autumn 2020).



HOME + CONTROL CONFIGURATION IS EASY, BOTH FOR YOU AND YOUR CUSTOMER.

You simply have to download the App from the Apple or Google store, and follow the guided procedure.

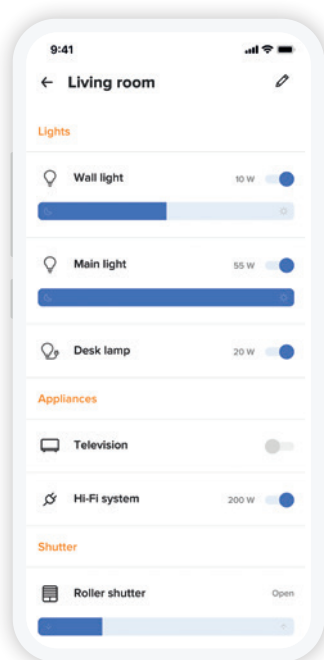

Lights, shutters
and generic loads activations

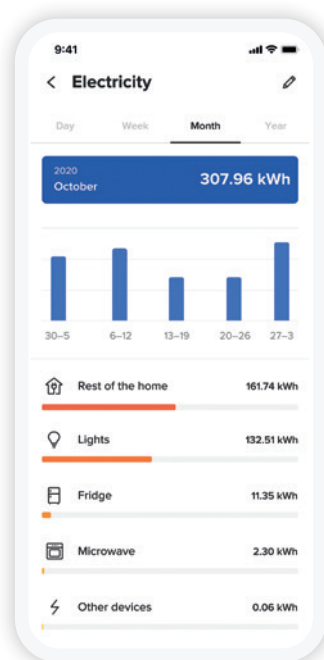

Consumption
display

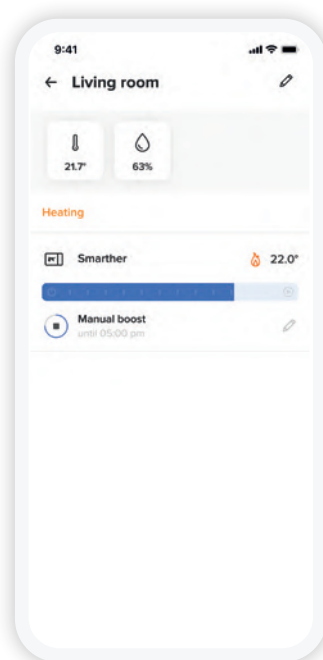

Management of the
temperature

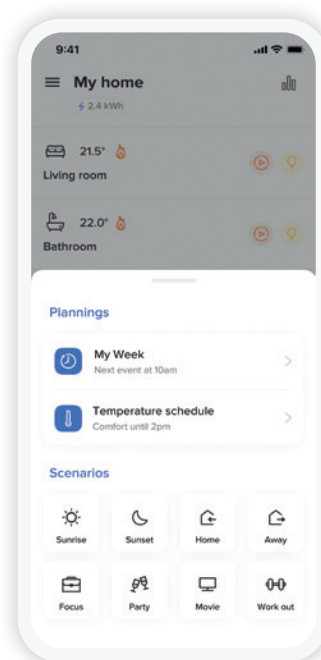

Scenario
management



INTEGRATION WITH IFTTT

The Living Now Smart functions can be extended thanks to the integration with the IFTTT platform. It will be possible to create automated actions based on events generated in the electric system, or by external services and connected third-party devices.

«OK Google,
set Kitchen light to 100%»

YOUR CUSTOMERS CAN ALSO MANAGE THEIR HOME WITH THEIR VOICE

With Living Now with Netatmo, your customer will be able to control the system using Apple, Google and Amazon voice assistants. An extremely useful features, also for those with mobility problems.

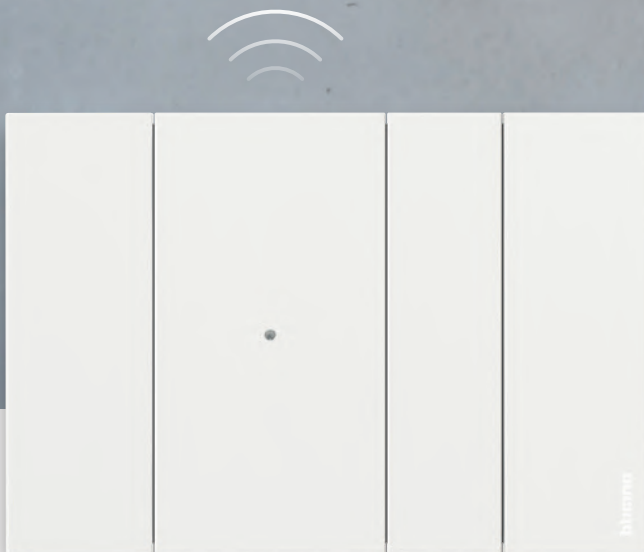

Gateway for the connection of the system to the Internet through the Home Wi-Fi network.

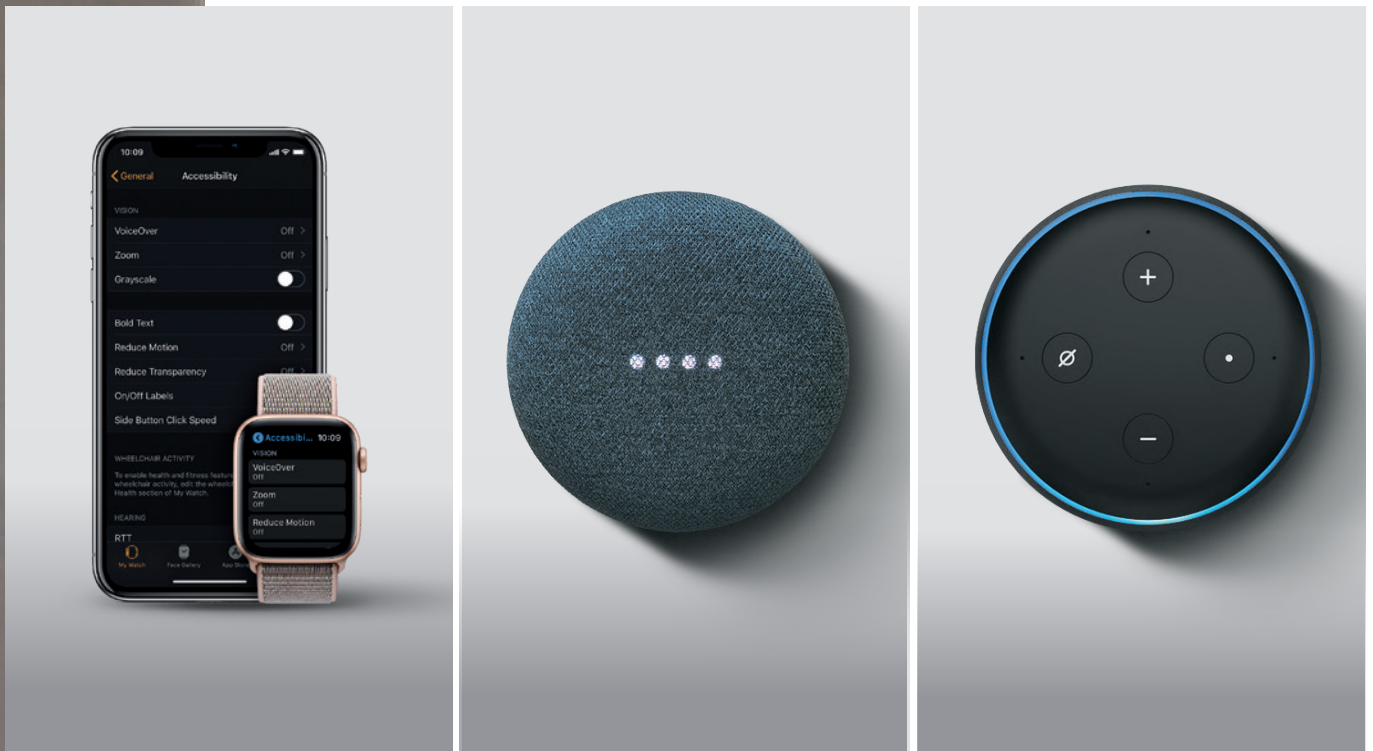

“SIRI, switch the bedroom light on”,
“OK Google, switch all the home lights off”,
“ALEXA, set temperature to 20 degrees”.



Smart electrical system a simple, rational range of connected devices, both wired and wireless.

REMOTE CONNECTION

CONNECTED DEVICES (230V A.C.)

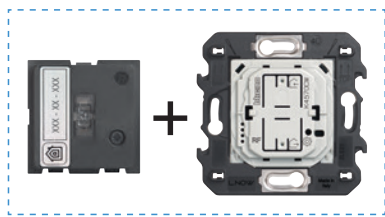

Item K4500C
Gateway with Home/Away wireless switch

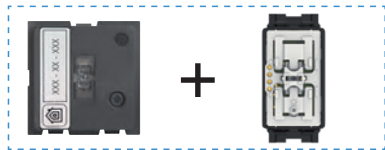

Item K4510C
Gateway with Home/Away wireless switch



Item FC80GT
Gateway DIN

SCENARIOS

BATTERY WIRELESS CONTROLS

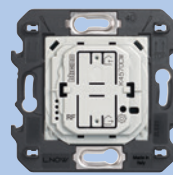
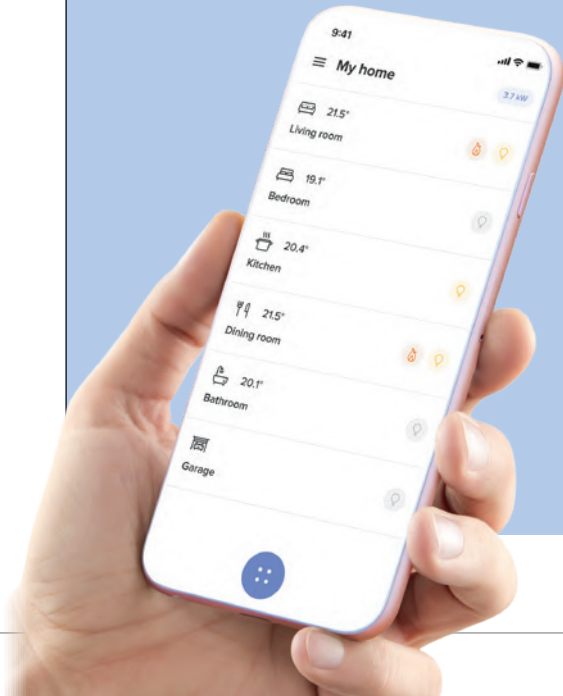

Item K4570CW
Home/Away wireless switch



Item K4570CWI
Home/Away wireless switch

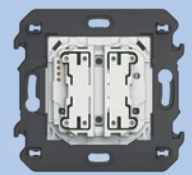

Item K4575CW
4 scenarios control

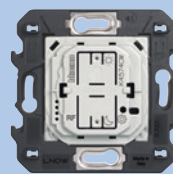

Item K4574CW
Night&Day scenario control



Item K4574CWI
Night&Day scenario control



Item 3528C
Pocket remote control 4 scenarios

LIGHTS



Item K4003C
Connected two-way switch



Item K4411C
Connected switch/dimmer



Item FC80RC
Connected DIN relay 16 A



Item 3584C
Connected light relay 1,3 A

SHUTTERS



Item K4027C
Connected shutter control

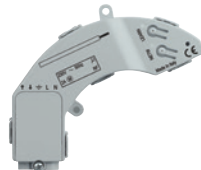

Item 4027C
Connected micromodule for shutter

ENERGY AND CONSUMPTION MANAGEMENT



Item K4531C
Connected module for socket -16 A



Item F20T60A
Connected DIN meter
Item FC80GCS Modulo DIN load management



Item FC80CC
Connected DIN contactor 20 A

Item K4003CW
Light control

Item K4003DCW
Double light control

Item K4027CWI
Shutter control

Item K4027CW
Shutter control

Item K4003CWI
Light control

Item 3585C
Motion sensor

Item 3577C
Wireless module for mechanical switch



Item 4141PC
Mobile german standard power outlet



Item 4142PC
Mobile french/belgian standard power outlet

Connected thermostat
Item XW8002
Item XW8002W
Item XM8002
Item XG8002



See catalogue for detailed descriptions, availability and full range of products.

IT IS INSTALLED JUST LIKE A TRADITIONAL ELECTRIC SYSTEM

1.

DEVICES ARE INSTALLED AND WIRED JUST LIKE TRADITIONAL DEVICES

In place of a traditional device, install the connected device of the corresponding type: one for each control line. Remember that the device must always be powered; therefore, ensure that the phase and neutral cables are present. Once installed, the connected control is already working; you will therefore be able to switch the connected light on without the need to do anything further.



EXAMPLE OF A REDIRECT LIGHT POINT

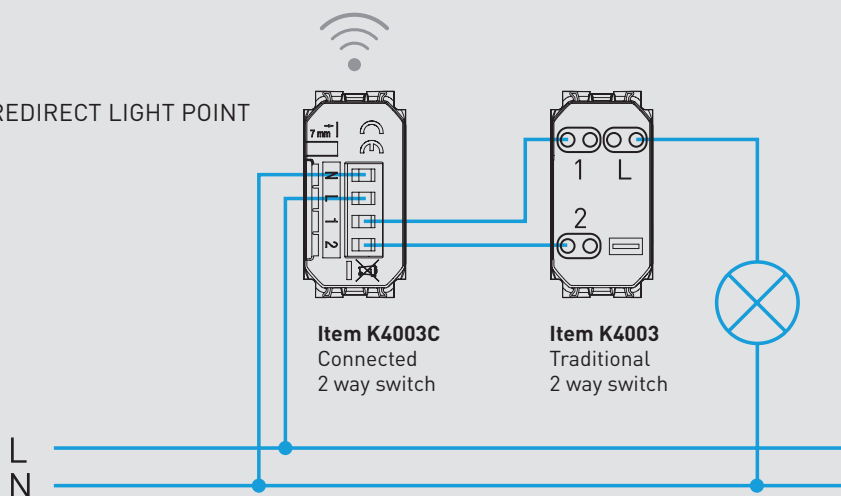

2.

DEVICES CAN BE ASSOCIATED TO EACH OTHER BY SIMPLY PRESSING A PUSHBUTTON

A. Power the electric system

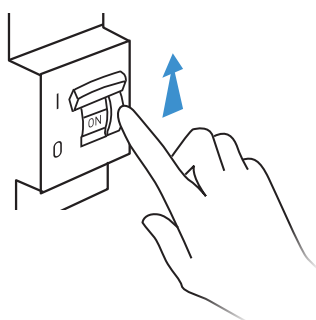

B. Press the In&Out master scenario control supplied with the gateway for 5 seconds

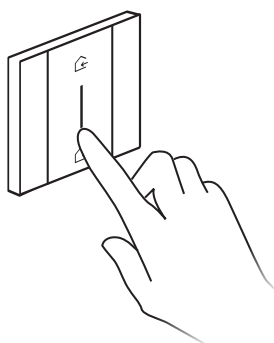

C. Devices are associated automatically. You can already use the IN&Out scenario control for the activation of the general "Going Out" control

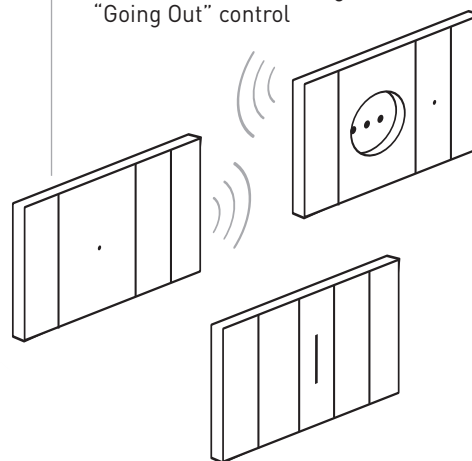

3.

DOWNLOAD THE HOME+CONTROL APP FROM THE STORES AND FOLLOW THE GUIDED PROCEDURE TO DEFINE THE OBJECTS TO MANAGE



App Home + Control



THE SYSTEM MAY BE EXPANDED WITH WIRELESS CONTROLS ASSOCIATED TO THE DEVICES BEING CONTROLLED

A. Press the In&Out master scenario control supplied with the gateway for 5 seconds

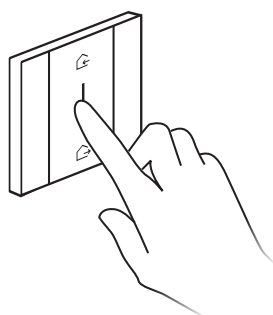

B. Place the devices to be associated in contact

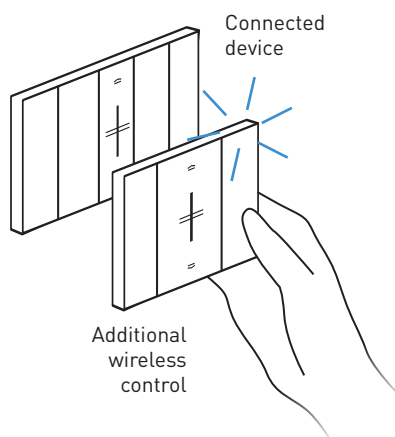

C. Install the wireless control anywhere you want, based on the needs of your customer

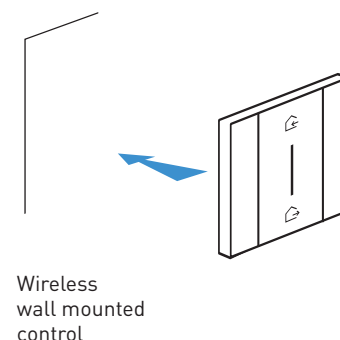



The **new** connected thermostat Smarter

WITH
Netatmo

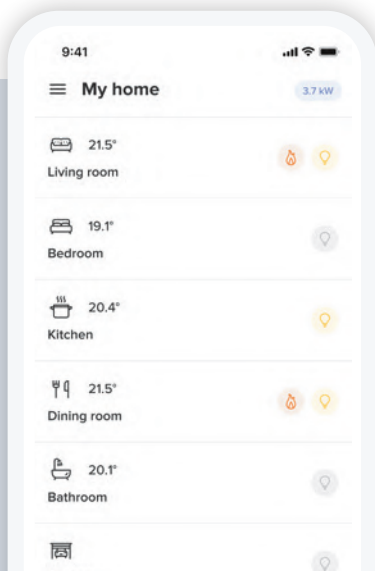

WITH THE APP IT'S ALL EASIER

- Remotely manage the thermostat simply and intuitively
- Create and modify the weekly programs
- Manage the thermostat from several smartphones and different users
- Control several thermostats in the same home or different homes
- Manage the thermostat updates
- Combine the voice command with your favorite voice assistant (Amazon Alexa, Apple Home Kit or Google Home)

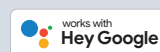
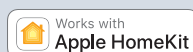

What can you do with the BTicino connected thermostat?



SETTING THE PROGRAMS

Using the Home + Control App, it is possible to set preset programs based on your habits



AWAY

If you need to be away from home for a few days you can, via the APP, act remotely to adjust the thermostat (e.g. in antifrost mode) independent of the automatic programming.



BOOST

The Boost function can be used to activate the heating or cooling system for a limited time (30, 60 or 90 minutes), irrespective of the set program and the ambient temperature.



MONITORING OF CONSUMPTIONS

Using the Home + Control App, it is possible to easily manage and monitor consumptions.



MAXIMUM COMFORT IN EVERY ZONE

Using the same App, it is possible to manage several thermostats in the same home or in different homes, as well as set the desired temperature in every room for maximum comfort, thanks to the compatibility with Netatmo smart radiator valves.



The connected thermostat is simple and intuitive



Display the temperature and set it as desired



Display the set room temperature and humidity



Activate the Boost function



LOCAL DEVICE CONTROL



VOICE CONTROL



GEOLOCATION

INSTALL A MyHOME_Up SYSTEM USING THE LIVING NOW RANGE



Voice control



Light and Full digital controls

BUS



The range of home automation devices is completed by two innovative Living Now digital controls offering innovative control of your system:

- voice control with built-in Amazon Alexa voice assistant
- Light and Full digital controls.

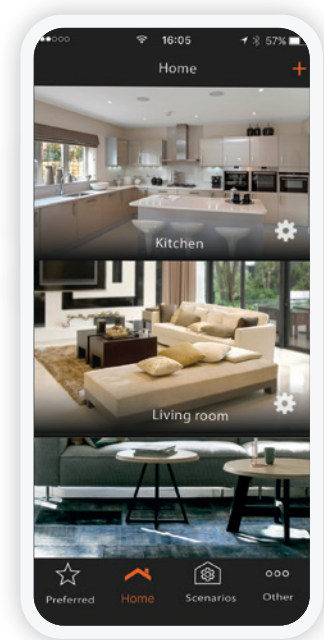

App MyHOME_Up



Display thermostat

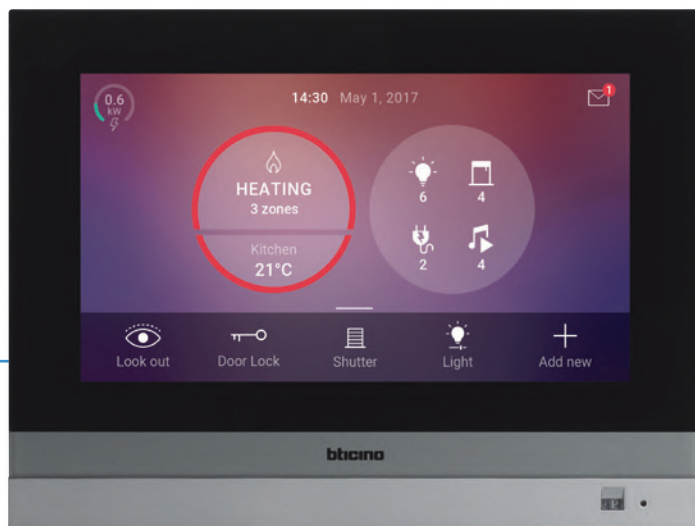

Touch Screen HOMETOUCH (compatible with Netatmo cameras)

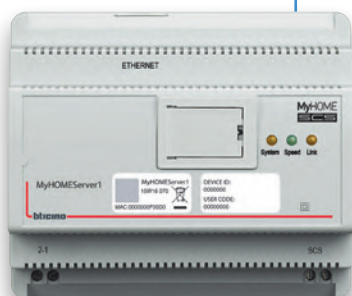

MyHOMEServer1

- NUVO audio system
- Third-party products and devices
- Indoor and outdoor Netatmo cameras

EVERYTHING UNDER CONTROL

Thanks to MyHOME_Up, end users can manage their homes in full freedom: using Living Now manual controls, Touch Screen devices and Smartphones with the MyHOME_Up App.

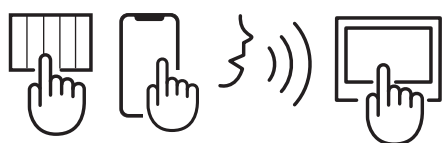

MyHOME_Up system can be managed by voice through the Voice Control Alexa built-in and also with the Amazon and Google vocal assistants

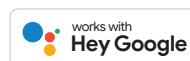

THE VOICE OF HOME AUTOMATION

**VOICE CONTROL:
INNOVATIVE DEVICE WITH INTEGRATED
AMAZON ALEXA VOICE ASSISTANT**

Set each room of your home as you like with a voice control that controls the MyHOME_Up system like never before.



"Alexa, welcome me home"

"Alexa, what will the weather be like tomorrow?"



**YOU ASK,
ALEXA ANSWERS.**

Use your voice to activate the home automation functions of your home: lights, shutters, scenarios, favourite music, or ask for any other information.

Note: with the "Welcome me home" scenario, it is possible to activate lights and shutters and disable the burglar alarm.

"Alexa, set the alarm for 7:30"

"Alexa, switch off the lights"

"Alexa, activate the relaxation scenario"



Note: with the "Relax" scenario, it is possible to activate lights and shutters, set a comfort temperature and listen to the preferred music through the NUVO multi-room system.

A NEW WAY TO TOUCH HOME AUTOMATION

LIGHT CONTROLS AND FULL CONTROLS: A MULTISENSORIAL EXPERIENCE

- New touch controls without cover plate
- Customised icons and leds using the app MyHOME_Up
- Light and Full controls expandable to new functions



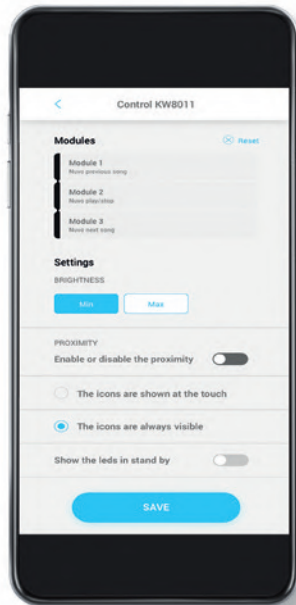

App Digital Controls

CREATE CUSTOMISABLE FUNCTIONS

The function associated to the control device and the corresponding icon can be changed at any moment, also by the end user, using the app Digital Controls.

FUNCTION MODIFICATION



From dimmer control



To shutter control

FUNCTION EXTENSION



From the control of one light



To the control of two lights



LIGHT CONTROL
To manage the lighting
(1 or 2 lights, group and general)

CHOOSE BETWEEN FULL AND LIGHT CONTROLS

Digital controls for every need.
Two versions, endless customisation to be adapted to life style.



FULL CONTROL
From 1 to 3 light, dimmer, rolling shutter, nuvo audio, load control and scenario.

EXTEND THE CONTROL

Expand the system by adding new control devices with a new frame. Without wiring.

FROM 3 CONTROL DEVICES

TO 4 CONTROL DEVICES

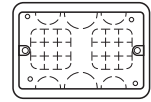
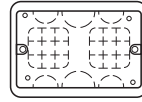

503E box

503E box

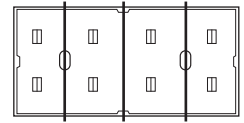
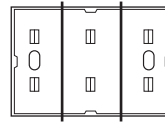

3 module-frame

4 module-frame



Digital controls

Digital controls



MOVE THE POSITION

With a simple operation, it is possible to change the position of a control device, maintaining its function. Without wiring.



FROM THE LIVING ROOM



TO THE BEDROOM

INSTALLATION OF DIGITAL CONTROLS

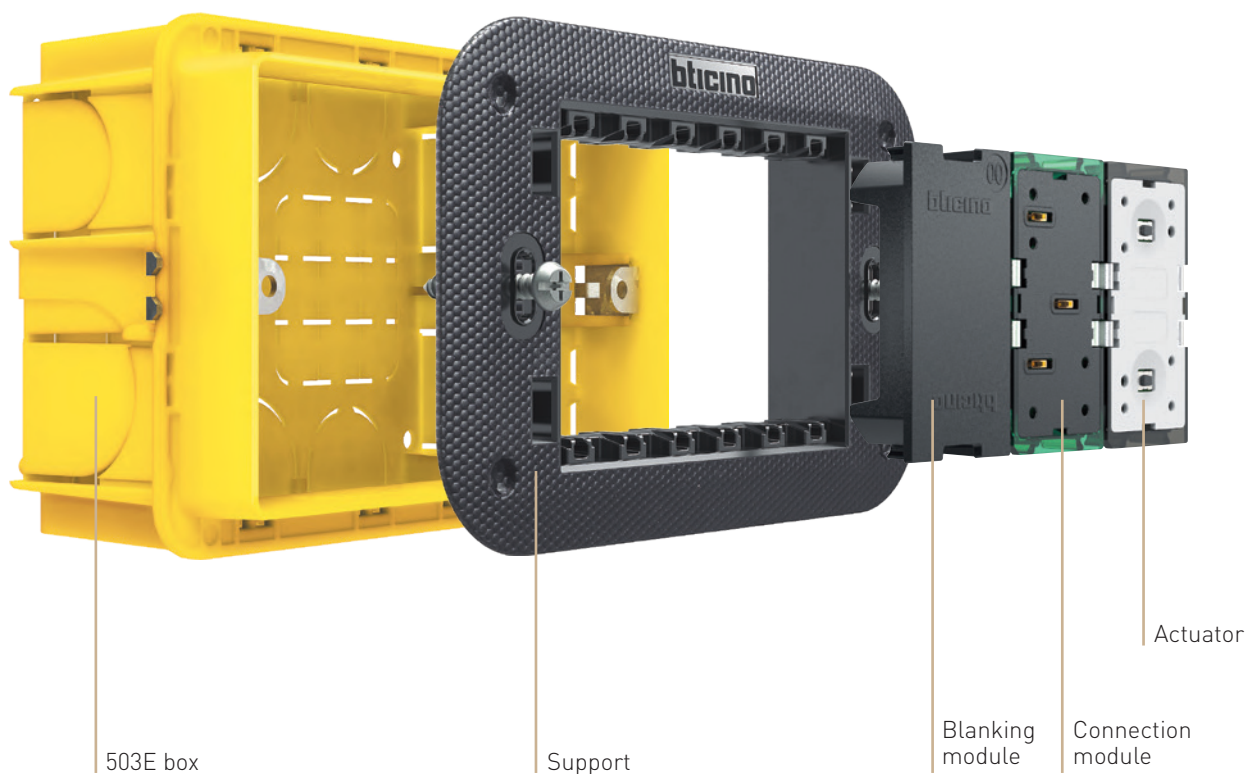

FUNCTIONAL ELEMENTS

INSTALLATION

With reference to the illustration, digital devices are installed in their respective flush mounted box and support, item K470..., using an appropriate "frame" with 27 Vd.c. control device power supply contacts.

The Module for connection to the system BUS and any flush mounted actuators are installed on the support.

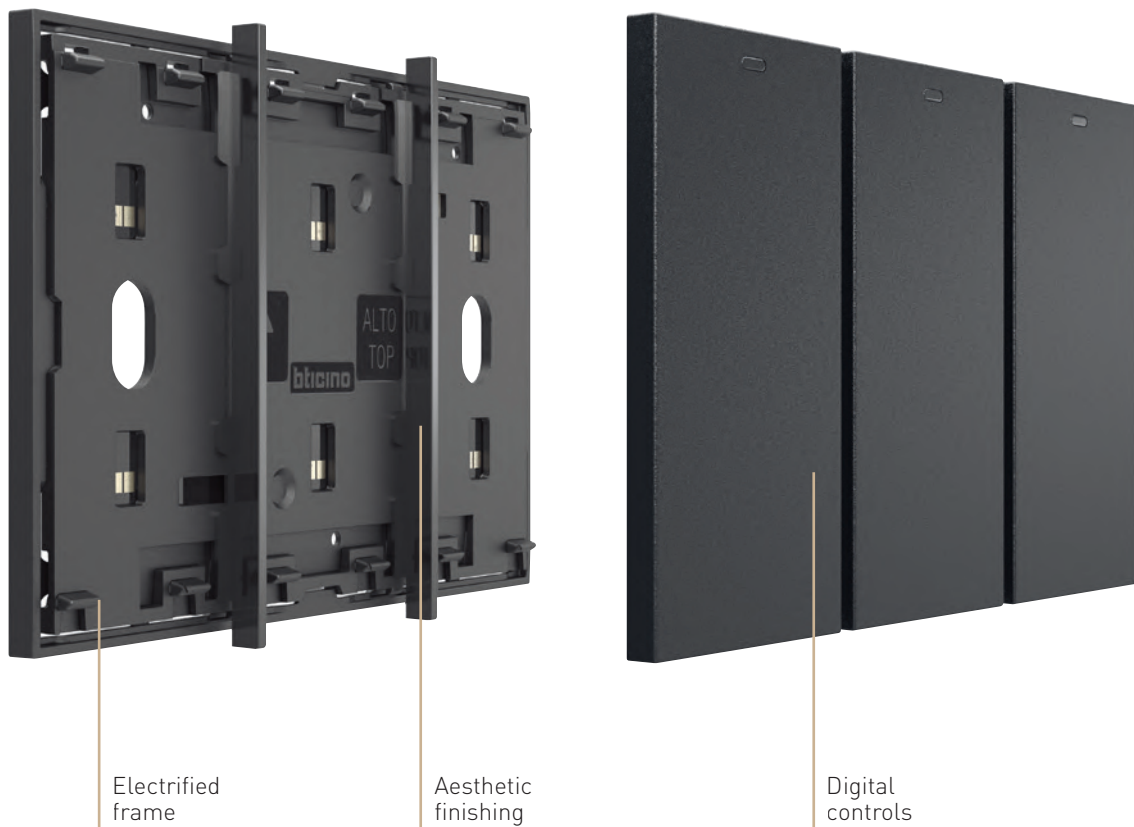

Electrified frame

Aesthetic finishing

Digital controls

AESTHETIC ELEMENTS

INSTALLATION OF VOICE CONTROL

This operation is completed in a similar way as the installation of digital controls, but it requires the removal of the two vertical finishing elements from the electrified frame.

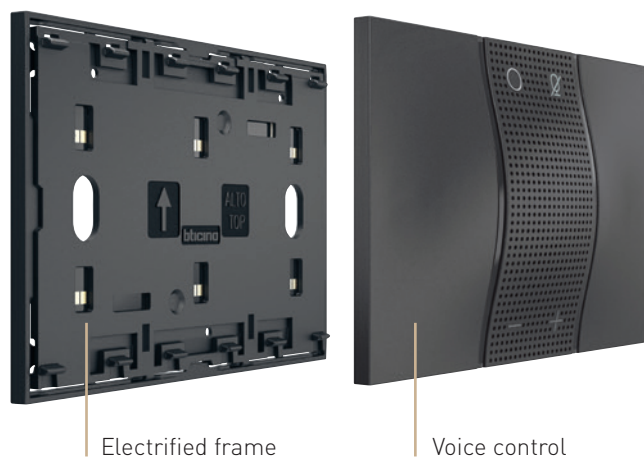

Electrified frame

Voice control

ALWAYS PERFECT INSTALLATION

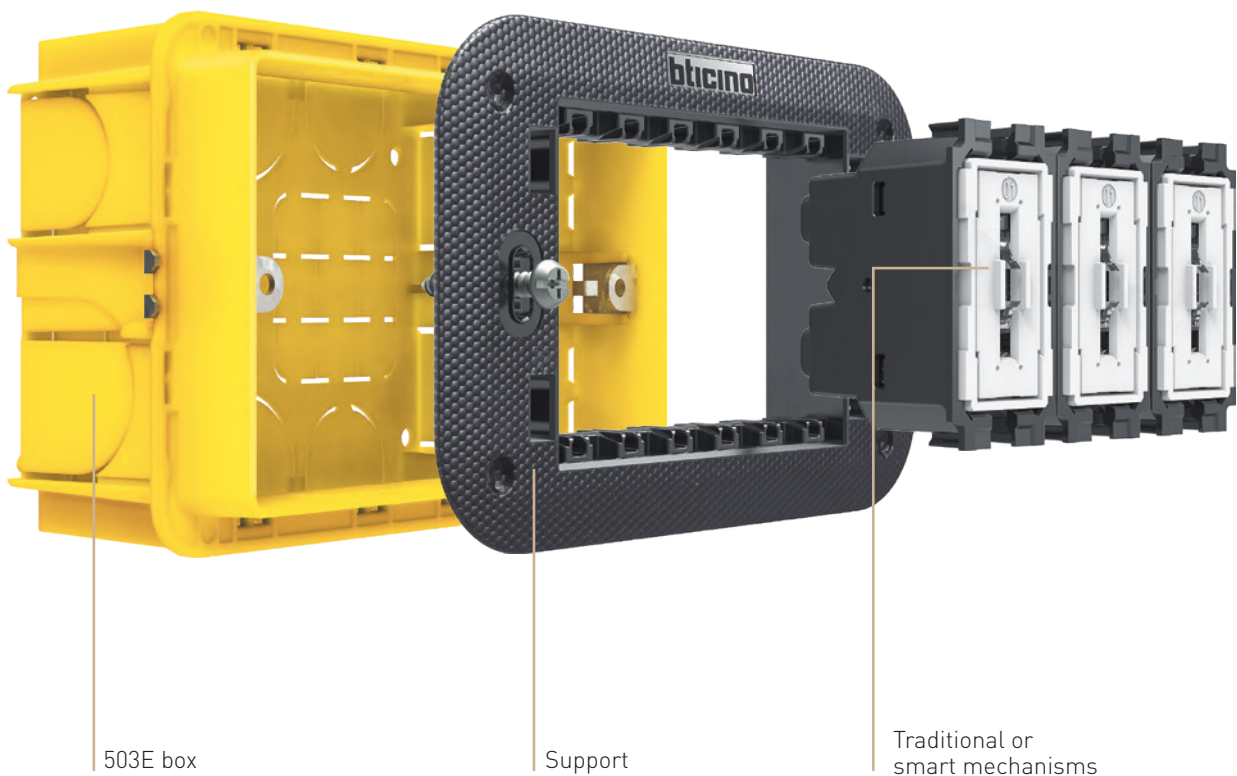

FUNCTIONAL ELEMENTS

STANDARD INSTALLATION

Both in case of **traditional** and **connected devices**, installation is always standard, with the following characteristics:

- traditional wiring;
- flush mounted or plasterboard boxes, typically 2 to 6 modules;;
- no configuration required.

YOUR WORK DOES NOT CHANGE, BUT IS MADE EASIER

The rules and procedures for the installation of the electric system don't change. Moreover, with the installation of the aesthetic components at the end of the works, you will hand to your customer a perfect and perfectly looking system.

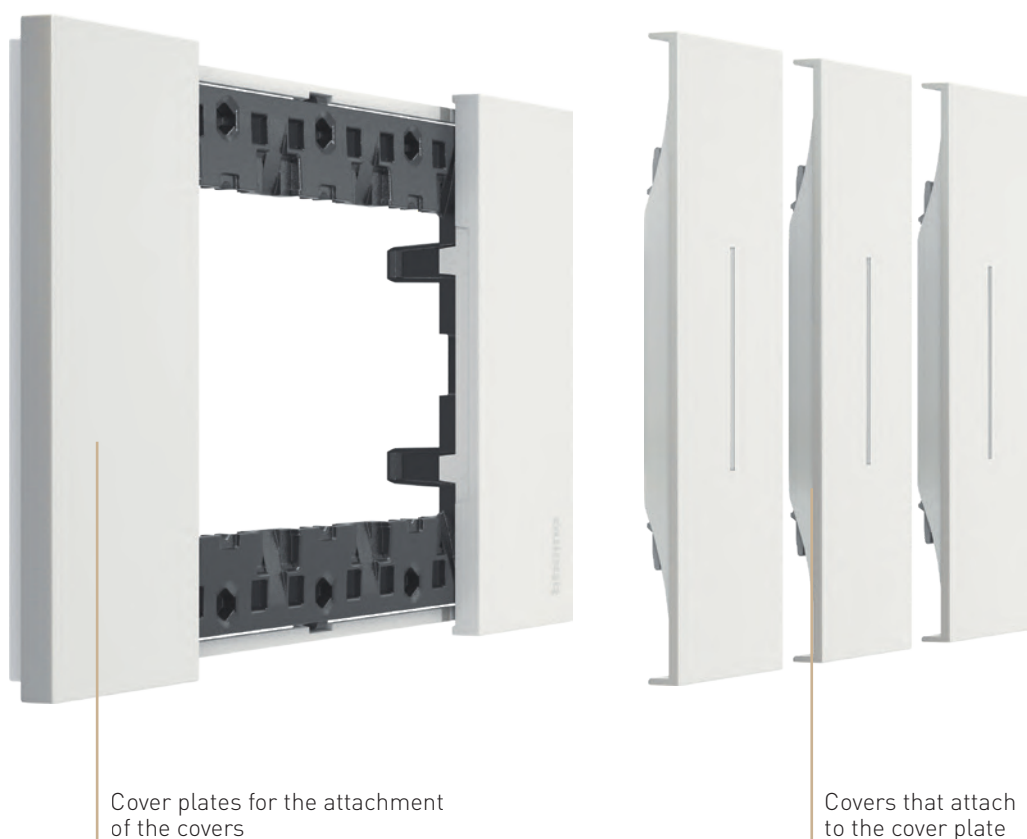

Cover plates for the attachment of the covers

Covers that attach to the cover plate

AESTHETIC ELEMENTS

SITE ACTIVITY SEQUENCE

- Install the system, fully working, but without aesthetic elements (cover plates and covers)
- Protect the light point using the protective shell (supplied with the support))
- After completing all the works (including the painting of the walls), install the cover plates and the covers

MORE ADVANTAGES

- When repainting the walls in the future, the customer will be able to easily remove the light point aesthetic components, cover plates and covers, and just as easily replace them on completion of the works
- After a few years the customer decides to change light points?
It is possible to simply change the covers, without touching the mechanisms

SOLUTIONS FOR AN ALWAYS PERFECT INSTALLATION

FULL TOUCH CONTROL: ERGONOMICS

All the surface is functional. It can be precisely activated from the top, bottom or centre, ensuring exceptional ergonomics.

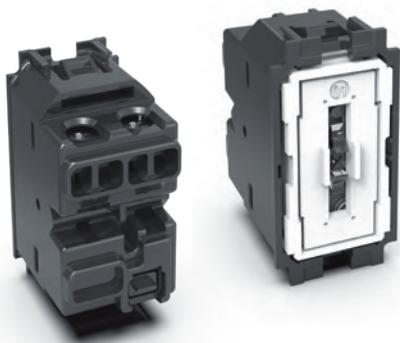

FULL TOUCH CONTROL: ELECTRO MECHANICS

1) tested with over 80,000 activations with the load connected; double than the standard requirements.

This equals over 40 years of "normal" use.

2) 10AX 250 V or 15AX 127 V, tested up to 700 A peak; also perfect for the new LED light bulbs, which generate significant peak current when switched on.

SELF CENTERING SYSTEM

This patented cover self-centering system ensures that the control covers are always aligned with the other components of the light point, even after extended use.

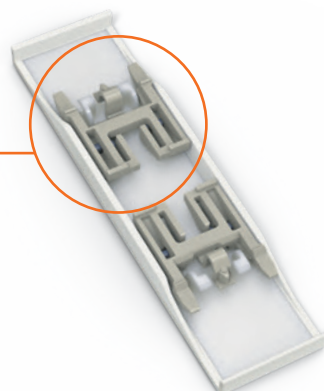

FLOATING FRAME

It's the flexible floating frame at the back of the cover plate that makes sure that the light point perfectly adheres to any wall.

The floating frame gives the possibility of:

- 1) hiding wall defects;
- 2) hiding any irregularity in flush mounted boxes their positioning;
- 3) hiding the external collars of plasterboard boxes.



STRONGER SUPPORT

Up to 4 times stronger than the current version, thanks to the new geometry and high performance materials.



BETTER PROTECTION

The support has a protective shell, which can be used to protect supports and mechanisms from possible damage during decorating activities, for example when painting the walls.

AN INTERNATIONAL STANDARD

MAIN MODULARITIES

With Living Now you can choose from a wide range of standards and modularity to get the solution that best suits your project.



ITALIAN / AUSTRALIAN
CHINESE / INDIAN
Standard

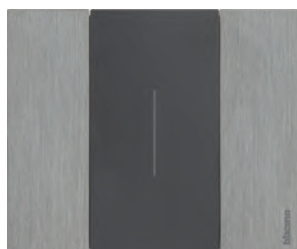

GERMAN AND FRENCH
Standard



GERMAN AND FRENCH
Standard

71 mm centre distance

SOCKET OUTLETS STANDARD

The socket outlets range
is complete of the main
international standards.

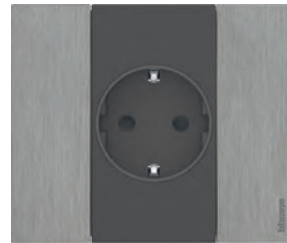

GERMAN



ITALIAN

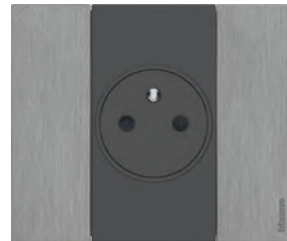

FRENCH / BELGIAN



AMERICAN

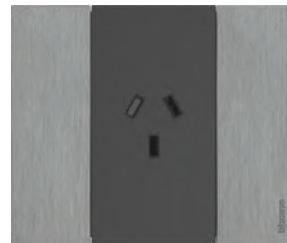

AUSTRALIAN



EURO / AMERICAN



ISRAELI



CHINESE



INDIAN



BRASILIAN



MULTISTANDARD

Traditional electrical system

main controls



Devices to be completed with appropriate cover as indicated below

Item	Switch, two-way switch, pushbutton, intermediate switch 10 AX - 250 V~
○ K4001	1P 10 AX, 250 V~, 1-way switch, screw and plates terminals, lightable - 1 module
○ K4001A	1P 10 AX, 250 V~, 1-way switch, automatic terminals, lightable - 1 module
○ K4001M2A	1P 10 AX, 250 V~, 1-way switch, automatic terminals, lightable - 2 modules
○ K4003	1P 10 AX, 250 V~ 2-way switch, screw and plates terminals, lightable - 1 module
○ K4003A	1P 10 AX, 250 V~ 2-ways switch, automatic terminals, lightable - 1 module
○ K4003M2A	1P 10 AX, 250 V~, 2-ways switch, automatic terminals, lightable - 2 modules
○ K4004	1P 10 AX, 250 V~ 4-way switch, screw and plates terminals - 1 module
○ K4004L	1P 10 AX, 250 V~ LIT 4-ways switch, screw and plates terminals, with white LED for backlighting (the LED is not interchangeable) - 1 module
○ K4004LB	1P 10 AX, 250 V~ LIT 4-ways switch, screw and plates terminals, with blue LED for backlighting (the LED is not interchangeable) - 1 module
○ K4004V127L	1P 10 AX, 127 V~ LIT 4-way switch, screw and plates terminals, with white LED for backlighting (the LED is not interchangeable) - 1 module
○ K4004V127LB	1P 10 AX, 127 V~ LIT 4-way switch, screw and plates terminals, with blue LED for backlighting (the LED is not interchangeable) - 1 module
○ K4005	1P (NO) 10 A, 250 V~ pushbutton, screw and plates terminal, lightable - 1 module
○ K4005A	1P (NO) 10 A, 250 V~ pushbutton, automatic terminals, lightable - 1 module
○ K4005M2A	1P (NO) 10 A, 250 V~ pushbutton, automatic terminals, lightable - 2 modules

Pushbutton 10 A - 250 V~

Item	Cover
<input type="checkbox"/> KW01 <input checked="" type="checkbox"/> KG01 <input type="checkbox"/> KM01	1 module Lightable cover for item K4001, K4003, K4004, K4004L, K4004LB, K4004V127L, K4004V127LB, K4005, K4034, K4001A, K4003A, K4005A
<input type="checkbox"/> KW01M2 <input checked="" type="checkbox"/> KG01M2 <input type="checkbox"/> KM01M2	2 modules Lightable cover for item K4001, K4003, K4004, K4004L, K4004LB, K4004V127L, K4004V127LB, K4005, K4034, K4001A, K4003A, K4005A, K4001M2A, K4003M2A, K4005M2A
<input type="checkbox"/> KW01X <input checked="" type="checkbox"/> KG01X <input type="checkbox"/> KM01X	Covers with symbols for controls 1 module - high brightness Lightable cover for item K4001, K4003, K4004, K4004L, K4004LB, K4004V127L, K4004V127LB, K4005, K4034, K4001A, K4003A, K4005A
<input type="checkbox"/> KW01M2X <input checked="" type="checkbox"/> KG01M2X <input type="checkbox"/> KM01M2X	2 modules - high brightness Lightable cover for item K4001, K4003, K4004, K4004L, K4004LB, K4004V127L, K4004V127LB, K4005, K4034, K4001A, K4003A, K4005A, K4001M2A, K4003M2A, K4005M2A
<input type="checkbox"/> KW01A <input checked="" type="checkbox"/> KG01A <input type="checkbox"/> KM01A	1 module - light symbol Lightable cover for item K4001, K4003, K4004, K4004L, K4004LB, K4004V127L, K4004V127LB, K4005, K4034, K4001A, K4003A, K4005A
<input type="checkbox"/> KW01M2A <input checked="" type="checkbox"/> KG01M2A <input type="checkbox"/> KM01M2A	2 modules - light symbol Lightable cover for item K4001, K4003, K4004, K4004L, K4004LB, K4004V127L, K4004V127LB, K4005, K4034, K4001A, K4003A, K4005A, K4001M2A, K4003M2A, K4005M2A
<input type="checkbox"/> KW01D <input checked="" type="checkbox"/> KG01D <input type="checkbox"/> KM01D	1 module - bell symbol Lightable cover for item K4001, K4003, K4004, K4004L, K4004LB, K4004V127L, K4004V127LB, K4005, K4034, K4001A, K4003A, K4005A
<input type="checkbox"/> KW01M2D <input checked="" type="checkbox"/> KG01M2D <input type="checkbox"/> KM01M2D	2 modules - bell symbol Lightable cover for item K4001, K4003, K4004, K4004L, K4004LB, K4004V127L, K4004V127LB, K4001A, K4003A, K4005A, K4001M2A, K4003M2A, K4005M2A.
<input type="checkbox"/> KW01F <input checked="" type="checkbox"/> KG01F <input type="checkbox"/> KM01F	1 module - key symbol Lightable cover for item K4001, K4003, K4004, K4004L, K4004LB, K4004V127L, K4004V127LB, K4005, K4034, K4001A, K4003A, K4005A
<input type="checkbox"/> KW01M2F <input checked="" type="checkbox"/> KG01M2F <input type="checkbox"/> KM01M2F	2 modules - key symbol Lightable cover for item K4001, K4003, K4004, K4004L, K4004LB, K4004V127L, K4004V127LB, K4005, K4034, K4001A, K4003A, K4005A, K4001M2A, K4003M2A, K4005M2A.

- Notes:

- for the LEDs to use see the "Backlighting LEDs" section later on in the catalogue.
- for solutions requiring 2-module covers for the main controls, it will be necessary to install two "half-module blanking modules" (item K4949) at the sides of the control, see examples of installation in the "Installation and cover plate range" section at the bottom of the catalogue.

White colour cover

Black colour cover

Sand colour cover

Neutral item (without cover)



Items in red colour: New products



Living Now with Netatmo smart electrical system

main controls
eliot

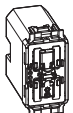
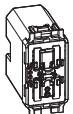

Devices to be completed with appropriate cover as indicated below

Item	Connected switches and light relay
○ K4001C	 <p>Connected 1-way switch. It controls the lights locally or remotely. It can be installed like a traditional two-way switch and is compatible with all loads with max. power 250 W. It has a blue LED, which can be configured using the Home + Control App for the localisation and load status functions. It can be associated to one or more wireless controls. Caution: neutral connection is necessary. Power supply 110-230 V~ - 1 module</p>
○ K4003C	 <p>Connected 2-ways switch. It allows to control lights locally or remotely. The connected 2ways switch has the same installation and usability of a traditional 2ways switch and it is compatible with all loads with max power 250 W. It s equipped with a blue LED light used always on for localization modality or on, when the light is on for the load status modality. It can be associated with "wireless light switches". Caution: Must be connected to the neutral. Power supply 110-230 V~ - 1 module</p>
○ 3584C	 <p>Connected lighting micromodule. It allows to control lights locally or remotely. It is compatible with all loads with max power 300 W. It can be connected to one or more traditional push-button or associated with "wireless light switches". It is installed as a traditional rele in the box (behind the button) or in derivation boxes. Caution: Must be connected to the neutral. Power supply 110-230 V~</p>
○ FC80RC	 <p>DIN switchboard light device for loads with absorption In= 16 A. Equipped with a meter measuring the current absorbed by the load and contacts for control with up to 10 pushbuttons. 1 DIN module. Power supply 110-230 V~</p>

Item	Cover
<input type="checkbox"/> KW01 <input checked="" type="checkbox"/> KG01 <input type="checkbox"/> KM01	1 module  Lightable covers for items K4001C and K4003C
<input type="checkbox"/> KW01M2 <input checked="" type="checkbox"/> KG01M2 <input type="checkbox"/> KM01M2	2 modules  Lightable covers for items K4001C and K4003C

Note: for the use of the connected devices, the gateway, item **K4500C**, **K4510C** or **FC80GT** must be installed as part of the system.

If the gateway is connected to the internet through the Wi-Fi network, it will be possible to manage the system from the home using the specific **HOME + CONTROL** App

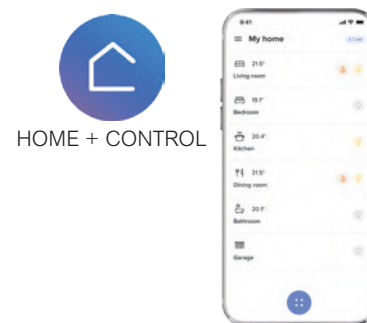

Three-point lighting control with connected two-way switch, item K4003C, installed instead of a traditional two-way switch

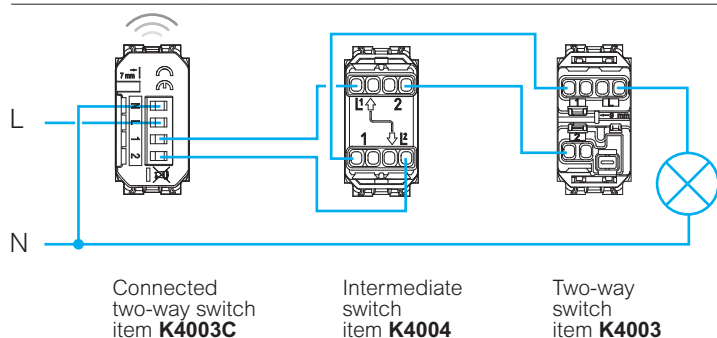

Three-point lighting control with pushbuttons and connected lighting micromodule, item 3584C, installed instead of a traditional relay

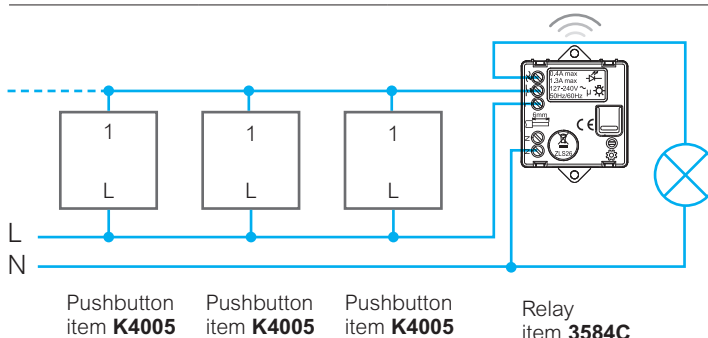





White colour cover
 Black colour cover
 Sand colour cover
 ○ Neutral item (without cover)





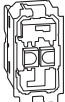

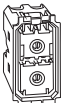

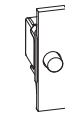

Items in red colour: New products

Traditional electrical system
control for shutters and fan



Devices to be completed with appropriate cover as indicated below







Item	Switch
○ K4027	 1P 10 AX, 250 V~ changeover switch, double-key 1-0-2, not lightable - 1 module
○ K4036	 10 A 250 V~ double pushbutton 1 P (NO) + 1 P (NO) not interlocked, not lightable - 1 module
○ K4037	 10 A 250 V~ double pushbutton 1 P (NO) + 1 P (NO) interlocked for shutters, not lightable - 1 module
<input type="checkbox"/> KW4017 <input checked="" type="checkbox"/> KG4017 <input type="checkbox"/> KM4017	 Fan controller 240V~ 100W 50Hz - The cover of the selected colour is supplied in the same box as the fan controller - for Indian std. installations - 2 module
<input type="checkbox"/> KW4018 <input checked="" type="checkbox"/> KG4018 <input type="checkbox"/> KM4018	 Fan controller 110-220 V~ 15-160 VA 50-60Hz - The cover of the selected colour is supplied in the same box as the fan controller - 1 module

Item	Cover
<input type="checkbox"/> KW06 <input checked="" type="checkbox"/> KG06 <input type="checkbox"/> KM06	1 module  Cover for item K4027
<input type="checkbox"/> KW06V <input checked="" type="checkbox"/> KG06V <input type="checkbox"/> KM06V	 Cover for item K4027 vertical installation
<input type="checkbox"/> KW05L <input checked="" type="checkbox"/> KG05L <input type="checkbox"/> KM05L	 Cover for item K4036
<input type="checkbox"/> KW05 <input checked="" type="checkbox"/> KG05 <input type="checkbox"/> KM05	 Cover for item K4037
<input type="checkbox"/> KW05V <input checked="" type="checkbox"/> KG05V <input type="checkbox"/> KM05V	 Cover for item K4037 vertical installation
<input type="checkbox"/> KW06M2 <input checked="" type="checkbox"/> KG06M2 <input type="checkbox"/> KM06M2	2 modules  Cover for item K4027
<input type="checkbox"/> KW05M2 <input checked="" type="checkbox"/> KG05M2 <input type="checkbox"/> KM05M2	 Cover for item K4037
<input type="checkbox"/> KW06M2V <input checked="" type="checkbox"/> KG06M2V <input type="checkbox"/> KM06M2V	 Cover for item K4027 vertical installation
<input type="checkbox"/> KW05M2V <input checked="" type="checkbox"/> KG05M2V <input type="checkbox"/> KM05M2V	 Cover for item K4037 vertical installation
<input type="checkbox"/> KW06M2VMC <input checked="" type="checkbox"/> KG06M2VMC <input type="checkbox"/> KM06M2VMC	 Cover for item K4027
<input type="checkbox"/> KW05M2VMC <input checked="" type="checkbox"/> KG05M2VMC <input type="checkbox"/> KM05M2VMC	 Cover for item K4037

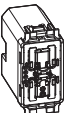
Living Now with Netatmo smart electrical system
control for shutters
eliot™

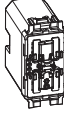

Devices to be completed with appropriate cover as indicated below

Item	Connected devices for shutters	Item	Cover
○ K4027C	 <p>Connected rolling shutter switch - It allows the control of a shutter locally or remotely. Compatible with all standard rolling shutter motors (with a mechanical or electromechanical stop and max power 500 VA) controlled by a wired shutter switch (switching of the same motor power supply). Not compatible with motors for radio-controlled or pulse-controlled roller shutters. It can be associated with one or more wireless commands. Caution: Must be connected to the neutral. Power supply 110-230 V~ - 1 module</p>	<input type="checkbox"/> KW32 <input checked="" type="checkbox"/> KG32 <input type="checkbox"/> KM32	1 module  Cover for item K4027C
○ K4027CIL	 <p>As above - interlocked modality</p>	<input type="checkbox"/> KW32M2 <input checked="" type="checkbox"/> KG32M2 <input type="checkbox"/> KM32M2	2 modules  Cover for items K4027C and K4027CM2
○ K4027CM2	 <p>As K4027C - 2 modules</p>		
○ K4027C	 <p>Connected micromodule for shutters. Associated to one or more shutter wireless controls, it controls a shutter locally or remotely. Compatible with all standard shutter motors (with mechanical or electronic limit switch and maximum power 500 VA), controlled by a wired shutter changeover switch (changeover with the same power supply as the motor). Not compatible with radio controlled or pulse controlled shutter motors. It can be installed in the existing shutter box with no need of masonry works. Power supply 110-230 V~</p>		

Note: for the use of the connected devices, the gateway, item **K4500C**, **K4510C** or **FC80GT** must be installed as part of the system.

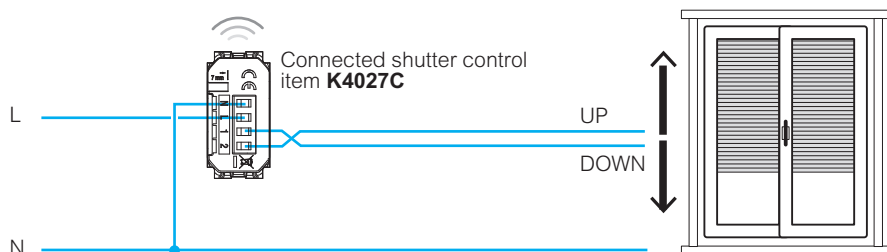

For correct operation, connect also the neutral conductor to the connected devices.

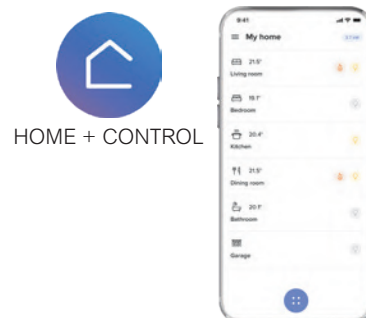

If the gateway is connected to the internet through the Wi-Fi network, it will be possible to manage the system from the home using the specific **HOME + CONTROL** App



Traditional electrical system
dimmer





Devices to be completed with appropriate cover as indicated below





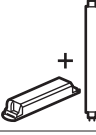
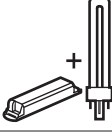
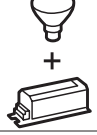





Item	Dimmer
○K4411	<p>Universal dimmer</p>  <p>Universal pushbutton dimmer - resistive/ inductive/ capacitive/fluorescent/compact/ dimmer LED. 100 to 240 V~ 50 ÷ 60 Hz - connection without neutral - 2 modules</p>
○K4410	<p>Dimmer for ballast lamp</p>  <p>Pushbutton dimmer for ballast lamp with 0-10V output. 100 to 240 V~ 50 to 60 Hz - 2 modules</p>

Item	Cover
□KW19	<p>1 module</p>  <p>Cover for item K4411, K4410</p>
■KG19	
□KM19	

DIMMER K4410 - LOADS MANAGED TABLE

		1 - 10 V		
				
 +35°C 0°C  2 x 2,5mm ² 100-240 V~ 50/60 Hz	240 V	Max 600 VA Min. 20 VA	Max 600 VA Min. 20 VA	Max 600 VA Min. 20 VA
	100 V	Max 300 VA Min. 20 VA	Max 300 VA Min. 20 VA	Max 300 VA Min. 20 VA

DIMMER K4411 - LOADS MANAGED TABLE

		R		L		C/L		Dimmable	Dimmable
									
 +35°C 0°C  2 x 2.5 mm ² 100- 240 V~ 50/60 Hz	240 V	Max. 400 W Min. 3 W	Max. 400 W Min. 3 W	Max. 400 VA Min. 3 VA	Max. 200 VA Min. 3 VA	Max. 400 VA Min. 3 VA	Max. 200 VA Min. 3 VA	75 W or max. 10 lamps 3 W	75 W or max. 10 lamps 3 W
	100 V	Max. 200 W Min. 3 W	Max. 200 W Min. 3 W	Max. 200 VA Min. 3 VA	Max. 100 VA Min. 3 VA	Max. 200 VA Min. 3 VA	Max. 100 VA Min. 3 VA	37 W or max. 10 lamps 3 W	37 W or max. 10 lamps 3 W

□ White colour cover ■ Black colour cover □ Sand colour cover ○ Neutral item (without cover)

Items in red colour: New products

Living Now with Netatmo smart electrical system

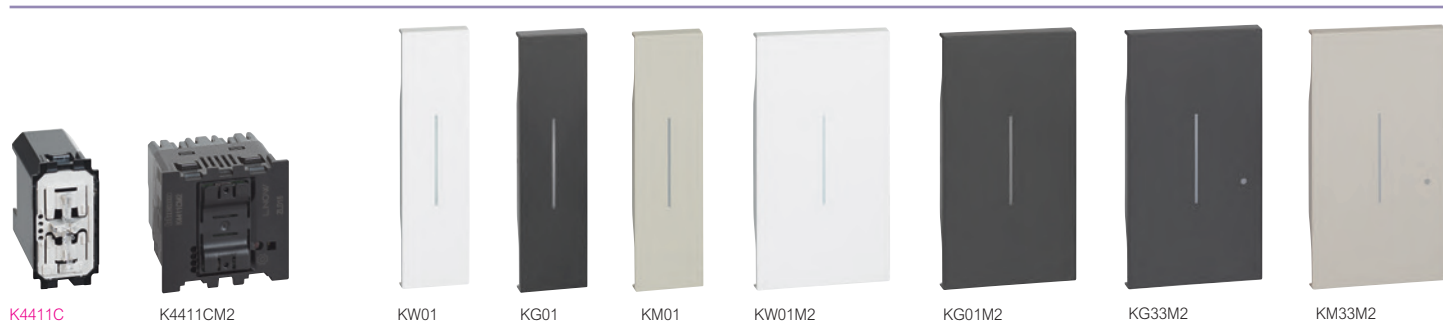

Devices to be completed with appropriate cover as indicated below

Item	Connected Dimmer/Switch
<input type="radio"/> K4411C	<p>Universal dimmer</p> <p>Dimmer/switch. It allows to control lights locally or remotely, with the dimmer functionality that can be activated from APP Home+Control. It has the same installation and usability of a traditional switch and it is compatible with all loads (LED, halogen) with max power 150 W at 230 V (or 75 W at 110 V). It is equipped with a blue LED light used for localization modality or load status modality, configurable by APP. It can be connected to one or more traditional push-button or associated with "wireless light switches". Caution: Must be connected to the neutral. Power supply 110-230 V~ - 1 module</p>
<input type="radio"/> K4412C	<p>Dimmer/switch including: - n° 1 item K4411C 1 module Dimmer/Switch (read item K4411C description for product features) - n° 2 items K4949 half-module blanking modules Note: it is necessary to install the two "half-module blanking modules" (item K4949) at the sides of the dimmer/switch (See examples of installation in the "Installation and cover plate range" section at the bottom of the catalogue).</p>
<input type="radio"/> K4411CM2	<p>Dimmer/switch without neutral. It allows to control lights locally or remotely, with the dimmer functionality that can be activated from APP Home+Control. It has the same installation and usability of a traditional switch and it is compatible with all loads (LED, halogen) with power 5-300 W at 230 V. It is equipped with a blue LED light used for localization modality or load status modality, configurable by APP. It can be connected associated with "wireless light switches". It doesn't require connection to the neutral, it comes with an active compensator. Power supply 110-230 V~ - 2 modules</p>

Note: for the use of the connected devices, the gateway, item **K4500C**, **K4510C** or **FC80GT** must be installed as part of the system.

If the gateway is connected to the internet through the Wi-Fi network, it will be possible to manage the system from the home using the specific **HOME + CONTROL** App

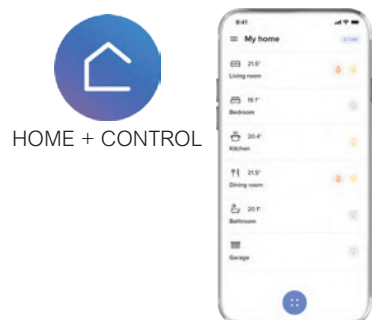

White colour cover Black colour cover Sand colour cover Neutral item (without cover)

Items in red colour: New products

Item	Cover
<input type="checkbox"/> KW01 <input checked="" type="checkbox"/> KG01 <input type="checkbox"/> KM01	<p>1 module</p> <p>Cover for item K4411C</p>
<input type="checkbox"/> KW01M2 <input checked="" type="checkbox"/> KG01M2 <input type="checkbox"/> KM01M2	<p>2 modules</p> <p>Cover for item K4411C and K4412C</p>
<input type="checkbox"/> KW33M2 <input checked="" type="checkbox"/> KG33M2 <input type="checkbox"/> KM33M2	<p>Cover for item K4411CM2</p>

Dimmer/switch item K4027C with remote pushbuttons

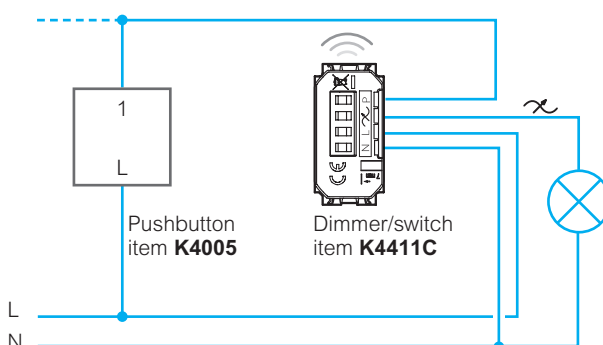

Traditional electrical system
other switches

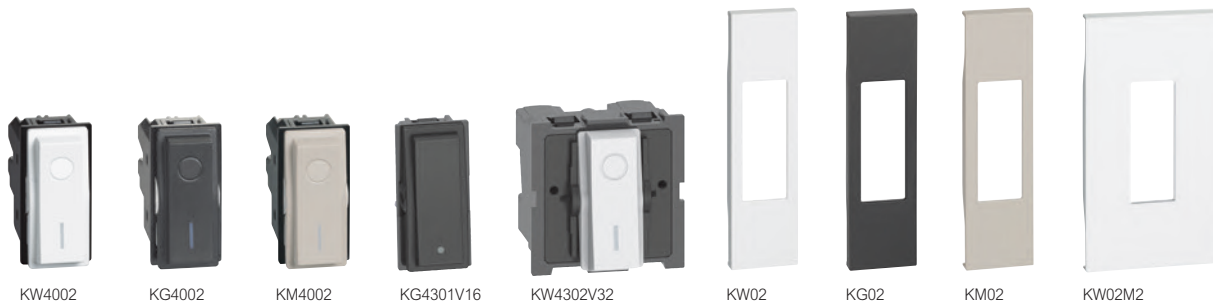

Devices to be completed with appropriate cover as indicated below

Item		Cover
Indian standard switches		
<input type="checkbox"/> KW4301V16 <input checked="" type="checkbox"/> KG4301V16 <input type="checkbox"/> KM4301V16	<p>1P 16 AX, 250 V~, 1-way switch, screw and plates terminals, with white LED for backlighting (the LED is not interchangeable) - 1 module</p>	1 module Cover for Item KW4301V16, KW4301V20 and KW4002 Cover for Item KG4301V16, KG4301V20 and KG4002 Cover for Item KM4301V16, KM4301V20 and KM4002
<input type="checkbox"/> KW4301V20 <input checked="" type="checkbox"/> KG4301V20 <input type="checkbox"/> KM4301V20	<p>1P 20 AX, 250 V~, 1-way switch, screw and plates terminals, with white LED for backlighting (the LED is not interchangeable) - 1 module</p>	
Two-pole switches		
<input type="checkbox"/> KW4002 <input checked="" type="checkbox"/> KG4002 <input type="checkbox"/> KM4002	<p>2P 16 AX, 250 V~, lightable switch - 1 module</p>	
Indian standard two-pole switches		
<input type="checkbox"/> KW4302V32 <input checked="" type="checkbox"/> KG4302V32 <input type="checkbox"/> KM4302V32	<p>2P 32 A, 250 V~ switch, with white LED for backlighting (the LED is not interchangeable) - 1 module</p>	2 module Cover for Item KW4302V32, KW4301V16, KW4301V20 and KW4002 Cover for Item KG4302V32, KG4301V16, KG4301V20 and KG4002 Cover for Item KM4302V32, KM4301V16, KM4301V20 and KM4002
		<input type="checkbox"/> KW02 <input checked="" type="checkbox"/> KG02 <input type="checkbox"/> KM02 <input type="checkbox"/> KW02M2 <input checked="" type="checkbox"/> KG02M2 <input type="checkbox"/> KM02M2

White colour cover

Black colour cover

Sand colour cover





Neutral item (without cover)



Items in red colour: New products

Traditional electrical system other pushbuttons



Devices to be completed with appropriate cover as indicated below

Item	Pushbutton
○ K4034	 10 A 250 V \sim opening pushbutton 1 P (NO) and 1 P (NC), lightable - 1 module
<input type="checkbox"/> KW4033 <input checked="" type="checkbox"/> KG4033 <input type="checkbox"/> KM4033	Pull cord pushbutton  10 A 250 V \sim pull-cord pushbutton 1 P (NO) and 1 P (NC) - 1 module
○ K4040	Plate pushbutton  3 A 250 V \sim door pushbutton - backlit with LED technology (already installed), cover supplied in package with the pushbutton - 2 modules
○ K4040V12	 Door pushbutton as above - 12 V \sim

Item	Cover for pushbutton
<input type="checkbox"/> KW01 <input checked="" type="checkbox"/> KG01 <input type="checkbox"/> KM01	1 module  Cover lightable for item K4034
<input type="checkbox"/> KW02 <input checked="" type="checkbox"/> KG02 <input type="checkbox"/> KM02	1 module  Cover for item KW4033 Cover for item KG4033 Cover for item KM4033
<input type="checkbox"/> KW02M2 <input checked="" type="checkbox"/> KG02M2 <input type="checkbox"/> KM02M2	2 module  Cover for Item KW4033 Cover for Item KG4033 Cover for Item KM4033

White colour cover

Black colour cover

Sand colour cover

○ Neutral item (without cover)

Items in red colour: New products

Traditional electrical system

IR switches



K4431

K4432

K4430



KW16



KG16



KM16

KG17

KM17SL

Devices to be completed with appropriate cover as indicated below

Item	IR switches
○ K4431	 <p>Switch with passive infrared ray movement sensor, suitable for all types of load including LED lamps - 3 wires – variable-threshold twilight circuit with possibility of exclusion – timing circuit to delay switching off adjustable from 30 seconds to 10 minutes - 230 V~ power supply - 1 module</p> <p>Note: for further information, see the technical section at the end of the Catalogue</p>
○ K4432	 <p>Switch with passive infrared ray movement sensor, suitable for all types of load including LED lamps - 3 wires – variable-threshold twilight circuit with possibility of exclusion – timing circuit to delay switching off adjustable from 10 seconds to 10 minutes - 230 V~ power supply - 2 modules</p> <p>Note: for further information, see the technical section at the end of the Catalogue</p>
○ K4430	 <p>switch with passive infrared ray movement sensor, suitable for all types of load including LED lamps - 2 wires – variable-threshold twilight circuit with possibility of exclusion – timing circuit to delay switching off adjustable from 10 seconds to 10 minutes - it has a selector switch for operating type ON - AUTO - OFF. It is possible to choose between two types of configuration:</p> <ol style="list-style-type: none"> 1) visible selector switch (install the selector switch supplied and use the cover item. ...17SL) 2) hidden selector switch (do not install the selector switch supplied and use the cover item ...17) - power supply 230 V~ - 2 modules <p>Note: for further information, see the technical section at the end of the Catalogue.</p>

Item	Cover
<input type="checkbox"/> KW16 <input checked="" type="checkbox"/> KG16 <input type="checkbox"/> KM16	1 module  Cover for item K4431
<input type="checkbox"/> KW17 <input checked="" type="checkbox"/> KG17 <input type="checkbox"/> KM17	2 modules  Cover for item K4432, K4430
<input type="checkbox"/> KW17SL <input checked="" type="checkbox"/> KG17SL <input type="checkbox"/> KM17SL	 Cover for item K4430

- **Note:** use item K4430 with ..17 or ..17SL covers
- cover .. 17SL: cover providing direct access to the selector. The device operating mode can be changed at any time as the selector is always exposed.
- cover .. 17: cover not providing access to the selector. To change the operating mode using the selector on the product, it will be necessary to remove the cover

Living Now with Netatmo smart electrical system

IR switch
eliot™



3585C

Item
○ 3585C

Motion sensor wireless



It controls one or more devices connected for light control.
 Infrared detection with angle of 140°.
 Distance of the adjustable sensor from 2 to 8 m.
 Switch off delay with 1 to 30 min adjustable delay time and 1 to 1000 lux brightness threshold.
 Test possible with a 5 sec. delay
 Recommended assembly height: 2.5 m.
 Optimum distance between 2 detectors: 6 m.
 For indoor and outdoor use (IP44).
 Supplied with 2 1.5V AA batteries for power supply.

Note: for the use of the connected devices, the gateway, item **K4500C**, **K4510C** or **FC80GT** must be installed as part of the system.

If the gateway is connected to the internet through the Wi-Fi network, it will be possible to manage the system from the home using the specific **HOME + CONTROL** App



HOME + CONTROL

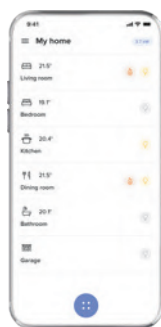

□ White colour cover

■ Black colour cover

□ Sand colour cover

○ Neutral item (without cover)

Items in red colour: New products

Traditional electrical system

thermostats



KW4441



KG4441



KM4441

Item

Electronic thermostats

- KW4441
- KG4441
- KM4441



Electronic room thermostat - relay output with
1 contact in switching free of 5(2)A potential.
- power supply 230 V~ - 2 modules

 White colour cover Black colour cover Sand colour cover Neutral item (without cover)

Items in red colour: New products

Living Now with Netatmo smart electrical system

thermostats
eliot™



The Smarter with Netatmo connected thermostat, together with the dedicated HOME+CONTROL APP, is a device which allows you to adjust and monitor the temperature in the rooms precisely and accurately; all the programming and most of the functions are performed simply and intuitively using the APP. Thanks to its Wi-Fi connection, Smarter with Netatmo can be programmed and controlled remotely; it can also display the temperature and humidity measured in the room. The temperature level can be set locally for manual operation and the Boost mode can be activated. The Boost forces the switching on of the system for a limited time (30, 60 or 90 minutes) independent of the measured and programmed temperature.

It's also possible to set a different temperature in each room of the house for the maximum comfort, thanks to its compatibility with Netatmo smart radiator valves.

Smarter with Netatmo can also be controlled with Google, Amazon Alexa and Apple Home Kit voice assistants.



Features:

- 110 ÷ 230 V~, 50/60 Hz power supply;
- 2 W max absorption;
- maximum cable section 1 x 1.5mm²;
- temperature measurement 5 ÷ 40°C;
- temperature set-point 5 ÷ 40°C,
- increase of 0.5°C;
- 1-contact output in switching free of potential 5(2)A.

Types of installation:

- flush mounted, on boxes item 503E or 500 (for item 500 use the wall dowels)
- plasterboard, on boxes 2 module and 3 module

It is available in three colours: white (XW8002), sand (XM8002) and black (XG8002).

Item	Connected thermostats
<input type="checkbox"/> XW8002 <input checked="" type="checkbox"/> XG8002 <input type="checkbox"/> XM8002	 White Black Sand
XW8002W	 Features: as XW8002. Installation on the wall, using screws and dowels suitable for the installation surface (brickwork, plasterboard, tiles etc.). It is only available in white.



App HOME + CONTROL for management of connected devices



White colour cover

Black colour cover

Sand colour cover



Neutral item (without cover)

Items in red colour: New products

Traditional electrical system
italian standard sockets



Devices to be completed with appropriate cover as indicated below







Item	Italian standard sockets
<input type="checkbox"/> KW4113 <input checked="" type="checkbox"/> KG4113 <input type="checkbox"/> KM4113 <input checked="" type="checkbox"/> KR4113	2 P+E 10 A , 250 V~ socket - centre distance 19 mm - shielded tulip contacts ø 4 mm - 1 module  White Black Sand Red
<input type="checkbox"/> KW4180 <input checked="" type="checkbox"/> KG4180 <input type="checkbox"/> KM4180 <input checked="" type="checkbox"/> KR4180	Socket 2 P+E 16 A 250 Va.c. - centre distance 19 mm and 26 mm - shielded tulip contacts - for 2 P and 2 P+E 10 and 16 A plugs - 1 module  White Black Sand Red





Cover	1 module
<input type="checkbox"/> KW02 <input checked="" type="checkbox"/> KG02 <input type="checkbox"/> KM02 <input checked="" type="checkbox"/> KR02	 Cover for item KW4113, KW4180 Cover for item KG4113, KG4180 Cover for item KM4113, KM4180 Cover for item KR4113, KR4180

Living Now with Netatmo smart electrical system
connected devices for energy management
eliot™



Devices to be completed with appropriate cover as indicated below



Item	Connected devices for energy management
○ K4531C	 <p>Connected socket module - wiring to a power outlet, allows to remotely control appliances and check the consumption (instantaneous, daily, monthly). It is also possible to receive notifications in case of anomalous consumption. The connected socket module is compatible with any device electric and large appliances up to 16 A 3680 W max. (protected against overloads). It is equipped with a LED light lit in blue when it is on. This option can be enabled or disabled in the "Home+Control" app. It can be associated with "wireless light switches". Power supply 110-230 V~ - 1 module</p>
○ 4141PC	 <p>Mobile connected German standard power outlet -plug&play-. Directly connected to an existing socket, it allows remote control of all the connected electrical appliances. It also monitors the instantaneous, daily and monthly consumption. Compatible with all the devices with power up to 16 A 3680 W (with overload protection). It can be associated to wireless light controls. Power supply 110-230 V~</p>
○ 4142PC	 <p>As above French/belgian standard socket</p>
○ FC80CC	 <p>Connected contactor for single-phase and/or three-phase loads with maximum absorption In= 20 A. With meter for the measurement of the current absorbed by the load. Power supply 110-230 V~ - 1 DIN module</p>
○ F20T60A	 <p>Smart DIN meter. It allows to measure the electrical energy consumption of the entire single-phase system of the house (instantaneous, daily, monthly) and of the single electrical power lines. It allows the reception of notifications in case of reaching the maximum power foreseen by the contract to avoid annoying black-outs. A toroid is supplied to measure the input current. Power supply 100-240 V~ - 1 DIN module. (Only for single-phase systems).</p>
○ FC80GCS	 <p>Connected DIN load management module for the monitoring of the consumptions of the whole electric system, the powering or disconnection of the loads, and the setting of scenarios with priority or non-priority loads. When the maximum intended power is reached, the non-priority loads are temporarily disconnected to avoid black-outs. A toroid for the current reading is provided Power supply 110-230 V~ - 1 DIN module</p>

Item	Connected socket
<input type="checkbox"/> KW4141AC <input checked="" type="checkbox"/> KG4141AC <input type="checkbox"/> KM4141AC	 <p>2P+E 16 A 250 Va.c. German standard connected socket. It allows remote control of electric devices and also to monitor their consumption (instantaneous, daily, monthly). It is also possible to receive notifications that can be configured. Compatible with all the electric devices with power up to 16 A 3680W (with overload protection). Integrated with a 2-module support, it can be installed instead of an existing socket in a 40 mm deep box. Screw fixing and connection using automatic clamps It has a blue LED that lights up when the socket is ON and that can be configured by means of the Home + Control APP. It can be associated to one or more wireless light controls. Power supply 110-230 V~</p>
<input type="checkbox"/> KW4142AC <input checked="" type="checkbox"/> KG4142AC <input type="checkbox"/> KM4142AC	 <p>As above French/belgian standard socket</p>
<p>Cover</p>	
<p>1 module</p>	
<input type="checkbox"/> KW31 <input checked="" type="checkbox"/> KG31 <input type="checkbox"/> KM31	 <p>Cover for item K4531C</p>
<p>2 modules</p>	
<input type="checkbox"/> KW34M2 <input checked="" type="checkbox"/> KG34M2 <input type="checkbox"/> KM34M2	 <p>Cover for item KW4141AC Cover for item KG4141AC Cover for item KM4141AC</p>
<input type="checkbox"/> KW35M2 <input checked="" type="checkbox"/> KG35M2 <input type="checkbox"/> KM35M2	 <p>Cover for item KW4142AC Cover for item KG4142AC Cover for item KM4142AC</p>



Devices to be completed with appropriate cover as indicated below

<p>Item</p> <ul style="list-style-type: none"> <input type="checkbox"/> KW4501C <input checked="" type="checkbox"/> KG4501C <input type="checkbox"/> KM4501C 	<p>Gateway with socket</p>  <p>German standard socket. The gateway creates a connected installation in the home. It can be used to control lights, shutters, and electric appliances plugged into connected sockets: - using the smartphone and the Home + Control app - using the voice assistants - from the general control at the home entrance. It integrates a 2P+E 16 A 250 V~ German standard connected socket for the remote control of electric devices and to monitor their consumption (instantaneous, daily, monthly). Compatible with all the electric devices with power up to 16 A 3680W (with overload protection). It can be installed instead of an existing socket in a 40 mm deep box. Screw fixing and connection using automatic clamps It has a blue LED that lights up when the socket is ON and that can be configured by means of the Home + Control APP. It can be associated to one or more wireless light controls. It is also supplied with wireless master IN&OUT scenario control, required for the association of all connected devices. Power supply 110-230 V~</p>
<ul style="list-style-type: none"> <input type="checkbox"/> KW4502C <input checked="" type="checkbox"/> KG4502C <input type="checkbox"/> KM4502C 	<p>As above French/belgian standard socket</p> 

<p>Item</p> <ul style="list-style-type: none"> <input type="checkbox"/> KW51 <input checked="" type="checkbox"/> KG51 <input type="checkbox"/> KM51 	<p>Cover required for the gateway with socket</p> <p>2 modules</p>  <p>Cover required for all the gateways with sockets, in addition to the 2 modules cover for the socket part</p>
<ul style="list-style-type: none"> <input type="checkbox"/> KW34M2 <input checked="" type="checkbox"/> KG34M2 <input type="checkbox"/> KM34M2 <ul style="list-style-type: none"> <input type="checkbox"/> KW35M2 <input checked="" type="checkbox"/> KG35M2 <input type="checkbox"/> KM35M2 	<p>Cover for the socket</p> <p>2 modules</p>  <p>Cover for item KW4501C Cover for item KG4501C Cover for item KM4501C</p>  <p>Cover for item KW4502C Cover for item KG4502C Cover for item KM4502C</p>

EXAMPLE: FUNCTION, COVER PLATE & COVER COLOUR CHOICE

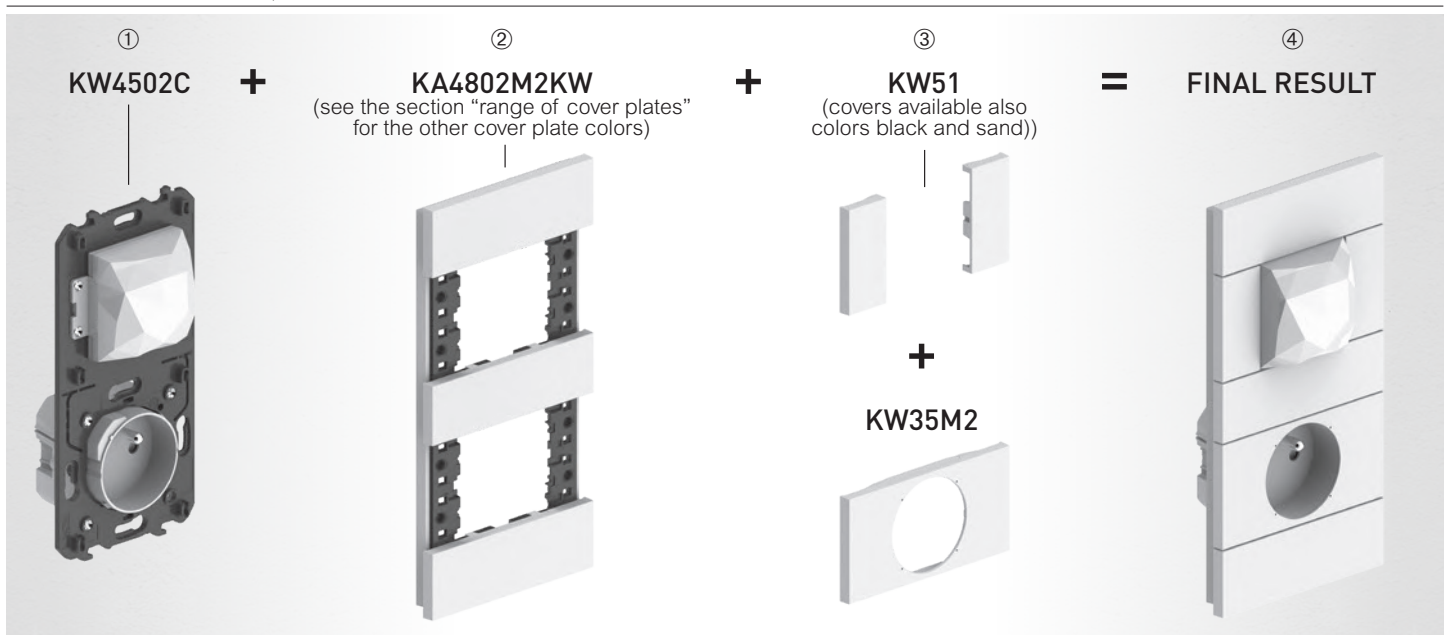

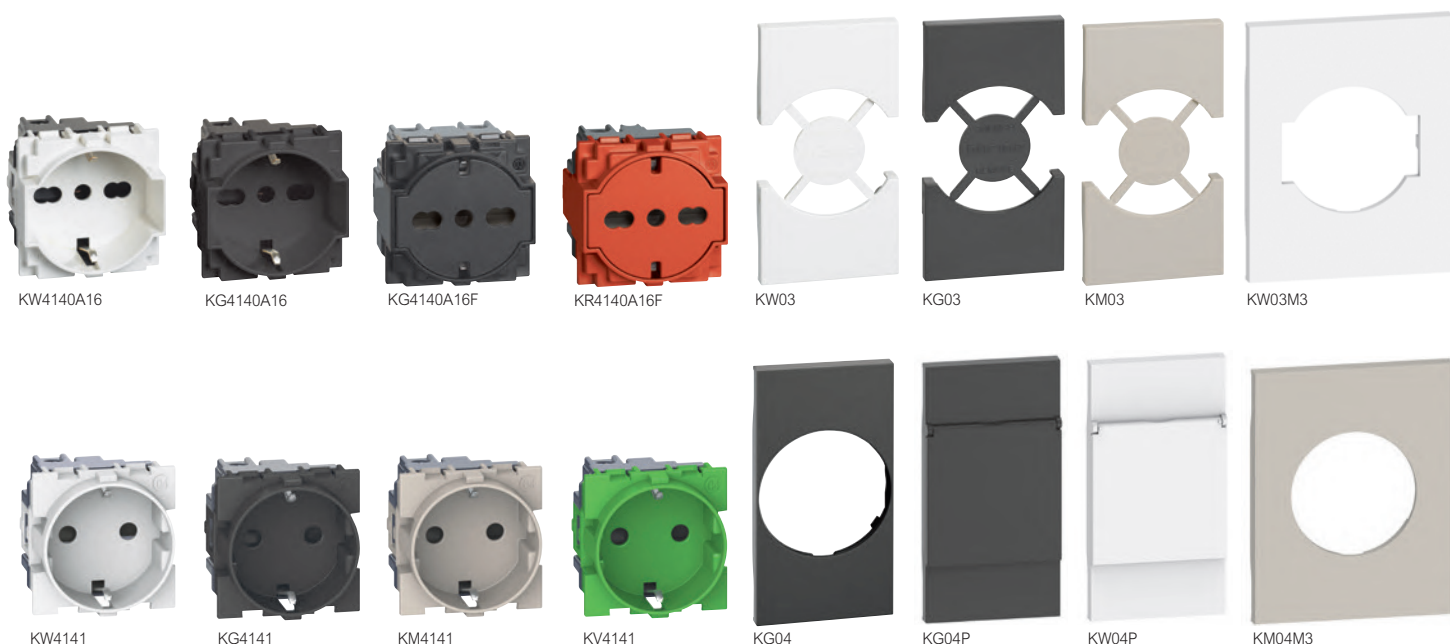

Traditional electrical system

italian/german and german standard sockets





Devices to be completed with appropriate cover as indicated below

Item	Italian/german standard sockets
<input type="checkbox"/> KW4140A16 <input checked="" type="checkbox"/> KG4140A16 <input type="checkbox"/> KM4140A16 <input checked="" type="checkbox"/> KR4140A16	 Socket 2 P+E 16 A 250 V \sim - 19 and 26 mm centre distance in 2-centre configuration - protected tulip contacts; side earth contact for German standard plugs; suitable for: Italian standard plugs 2P and 2 P+E 10/16 A, and 16A, German standard plugs 2P+E 16 A - 2 modules.
<input type="checkbox"/> KW4140A16F <input checked="" type="checkbox"/> KG4140A16F <input type="checkbox"/> KM4140A16F <input checked="" type="checkbox"/> KR4140A16F	 German and Italian standard flat socket. When the plug is inserted the socket surface slides inside the casing; it returns to its initial position when the plug is taken out. Socket 2 P+E 16 A 250 V \sim - 19 mm and 26 mm centre distance in 2-centre configuration - protected tulip contacts; side earth contact for German standard plugs; suitable for: Italian standard plugs 2P and 2 P+E 10/16 A, and 16A, German standard plugs 2P+E 16 A. - cannot be backlit - 2 modules

Item	German standard sockets
<input type="checkbox"/> KW4141 <input checked="" type="checkbox"/> KG4141 <input type="checkbox"/> KM4141 <input checked="" type="checkbox"/> KR4141 <input checked="" type="checkbox"/> KV4141	 German standard socket 2 P+E 16 A 250 V \sim socket with earth side contacts - shielded tulip contacts - with screw terminals
<input type="checkbox"/> KW4141A <input checked="" type="checkbox"/> KG4141A <input type="checkbox"/> KM4141A	 As above - automatic clamps

Item	Cover for italian/german standard sockets
<input type="checkbox"/> KW03 <input checked="" type="checkbox"/> KG03 <input type="checkbox"/> KM03 <input checked="" type="checkbox"/> KR03	2 modules  Cover suitable for italian/german standard sockets.
<input type="checkbox"/> KW03M3 <input checked="" type="checkbox"/> KG03M3 <input type="checkbox"/> KM03M3	3 modules  Cover suitable for italian/german standard sockets

Item	Cover for german standard sockets
<input type="checkbox"/> KW04 <input checked="" type="checkbox"/> KG04 <input type="checkbox"/> KM04 <input checked="" type="checkbox"/> KR04 <input checked="" type="checkbox"/> KV04	2 modules  Cover suitable for german standard sockets
<input type="checkbox"/> KW04P <input checked="" type="checkbox"/> KG04P <input type="checkbox"/> KM04P	2 modules with hatch  Cover suitable for german standard sockets
<input type="checkbox"/> KW04M3 <input checked="" type="checkbox"/> KG04M3 <input type="checkbox"/> KM04M3	3 modules  Cover suitable for german standard sockets

White colour cover
 Black colour cover
 Sand colour cover
 ○ Neutral item (without cover)





Items in red colour: New products

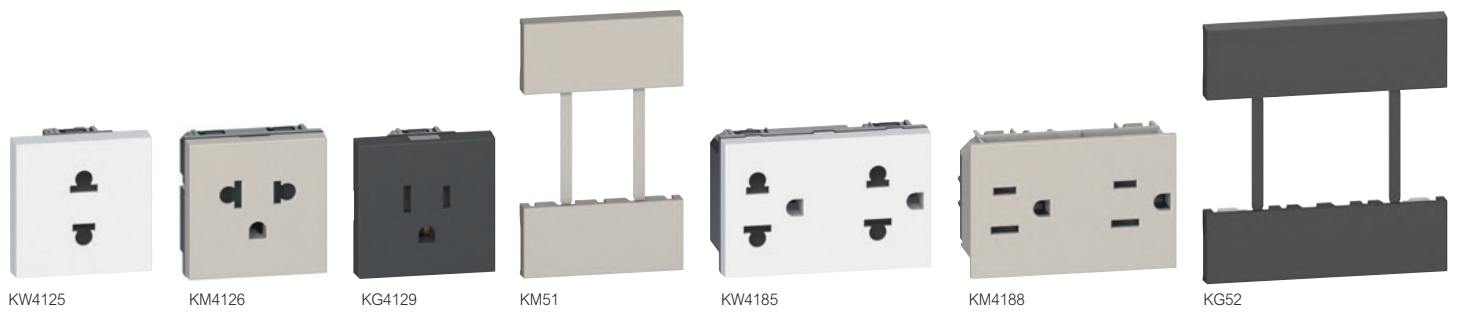

Traditional electrical system

European/american standard sockets



Devices to be completed with appropriate cover as indicated below

Item	European/american standard sockets
<input type="checkbox"/> KW4125 <input checked="" type="checkbox"/> KG4125 <input type="checkbox"/> KM4125	 Euro american standard 2 P 16 A 127/250 V~ socket - Ø 5 mm shielded tulip contacts - 2 modules
<input type="checkbox"/> KW4126 <input checked="" type="checkbox"/> KG4126 <input type="checkbox"/> KM4126	 Euro american standard 2 P+E 16 A 127/250 V~ universal duplex socket - Ø 5 mm shielded tulip contacts - 2 modules
<input type="checkbox"/> KW4129 <input checked="" type="checkbox"/> KG4129 <input type="checkbox"/> KM4129	 American standard 2 P+E 15 A 127/250 V~ socket - shielded tulip contacts - 2 modules
<input type="checkbox"/> KW4185 <input checked="" type="checkbox"/> KG4185 <input type="checkbox"/> KM4185	 Euro american standard 2 P+E 16 A 127/250 V~ universal duplex socket - shielded tulip contacts - 3 modules
<input type="checkbox"/> KW4188 <input checked="" type="checkbox"/> KG4188 <input type="checkbox"/> KM4188	 American standard 2 P+E 15 A 127/250 V~ universal duplex socket - shielded tulip contacts - 3 modules

Item	Cover for european/american standard sockets
<input type="checkbox"/> KW51 <input checked="" type="checkbox"/> KG51 <input type="checkbox"/> KM51	2 modules  Cover suitable for all the items over described
<input type="checkbox"/> KW52 <input checked="" type="checkbox"/> KG52 <input type="checkbox"/> KM52	3 modules  Cover suitable for all the items over described

White colour cover

Black colour cover

Sand colour cover

Neutral item (without cover)

Items in red colour: New products

Traditional electrical system

American standard sockets

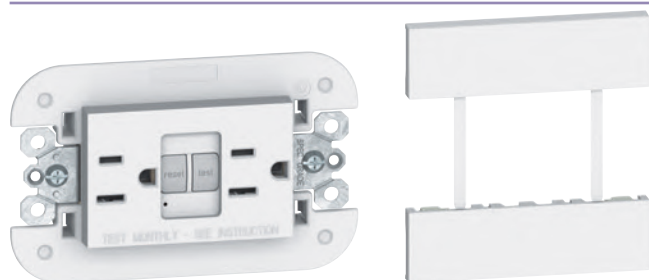

KW4188GFG6

KW52

Devices to be completed with appropriate cover as indicated below

Item	American standard sockets
<input type="checkbox"/> KW4188GFG6	 American standard 2 P+E 15 A 127 V~ GFCI socket - support frame included - 3 modules
<input checked="" type="checkbox"/> KG4188GFG6	
<input type="checkbox"/> KM4188GFG6	

Item	Multistandard socket
<input type="checkbox"/> OK4139	 Multistandard socket - 2 modules

Item	Israeli standard sockets
<input type="checkbox"/> KW4183	 2 P+E 10/16 A 250 Va.c. socket - 2 modules
<input checked="" type="checkbox"/> KG4183	
<input type="checkbox"/> KM4183	

Multistandard socket Israeli standard sockets



K4139



KM59

KW4183

KG04

Item	Cover for american standard sockets
<input type="checkbox"/> KW52	3 modules  Cover suitable for all the items over described
<input checked="" type="checkbox"/> KG52	
<input type="checkbox"/> KM52	

Item	Cover for multistandard socket
<input type="checkbox"/> KW59	2 modules  Cover suitable for item K4139
<input checked="" type="checkbox"/> KG59	
<input type="checkbox"/> KM59	

Item	Cover for israeli standard sockets
<input type="checkbox"/> KW04	2 modules  Cover suitable for all the items KW4183, KG4183, KM4183
<input checked="" type="checkbox"/> KG04	
<input type="checkbox"/> KM04	
<input type="checkbox"/> KW04P	2 modules with hatch  Cover suitable for all the items KW4183, KG4183, KM4183
<input checked="" type="checkbox"/> KG04P	
<input type="checkbox"/> KM04P	
<input type="checkbox"/> KW04M3	3 modules  Cover suitable for all the items KW4183, KG4183, KM4183
<input checked="" type="checkbox"/> KG04M3	
<input type="checkbox"/> KM04M3	

White colour cover

Black colour cover

Sand colour cover

Neutral item (without cover)

Items in red colour: New products

Traditional electrical system

French/belgian standard sockets, 2 modules, Cover & Top FLAT socket version

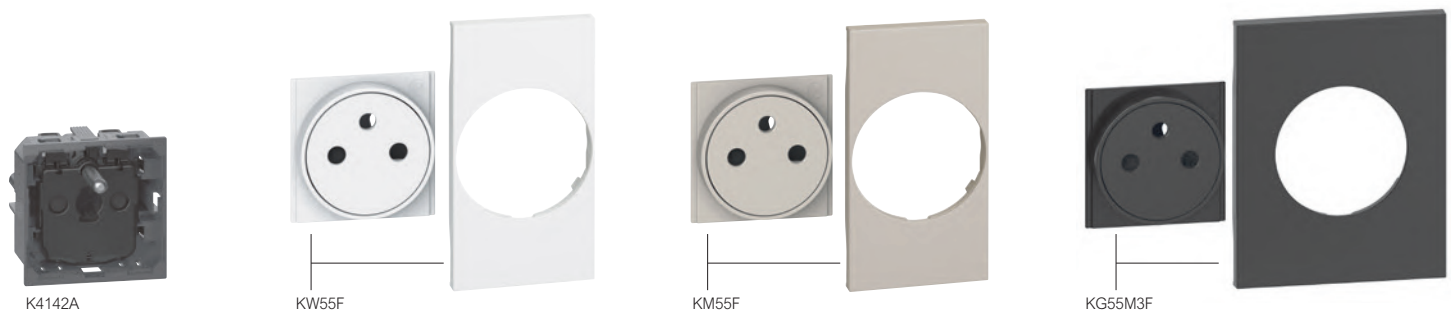

Devices to be completed with appropriate cover as indicated below

Item	French-Belgium standard sockets
OK4142A	 French-Belgium standard socket 2 P+E 16 A 250 V~ - automatic clamps - shielded tulip - 2 modules

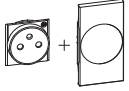
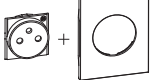
Item	Cover for FLAT socket version
<input type="checkbox"/> KW55F <input checked="" type="checkbox"/> KG55F <input type="checkbox"/> KM55F <input type="checkbox"/> KR55F <input type="checkbox"/> KV55F	2 modules  Cover for item K4142A (Red and green for special users)
<input type="checkbox"/> KW55M3F <input checked="" type="checkbox"/> KG55M3F <input type="checkbox"/> KM55M3F	3 modules  Cover for item K4142A

Note: if replacing only the 3-module cover, order the following codes: KG/KM/KW04M3

EXAMPLE: FUNCTION & COVER COLOUR CHOICE

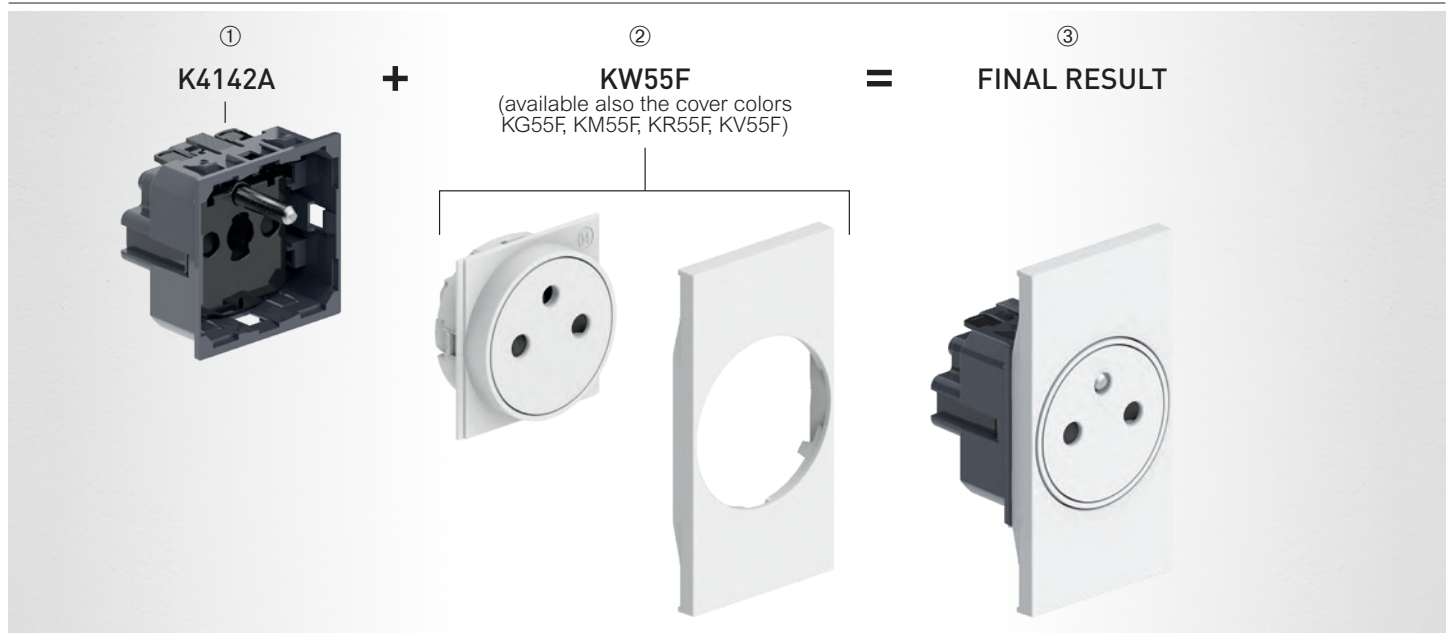

White colour cover
 Black colour cover
 Sand colour cover
 ○ Neutral item (without cover)

Items in red colour: New products

Traditional electrical system

French/belgian standard sockets, 2 modules,
Cover & Top STANDARD socket version

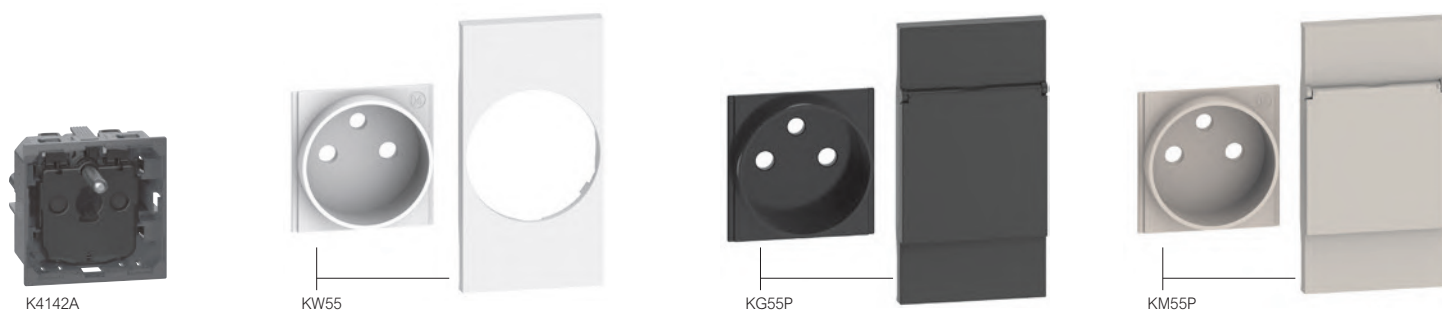

Devices to be completed with appropriate cover as indicated below

Item	French-Belgium standard sockets
OK4142A	 French-Belgium standard socket 2 P+E 16 A 250 V~ - automatic clamps - shielded tulip - 2 modules

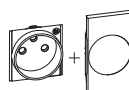
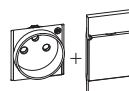
Item	Cover for STANDARD socket version
<input type="checkbox"/> KW55 <input checked="" type="checkbox"/> KG55 <input type="checkbox"/> KM55 <input type="checkbox"/> KR55 <input type="checkbox"/> KV55	2 modules  Cover for item K4142A (Red and green for special users)
<input type="checkbox"/> KW55P <input checked="" type="checkbox"/> KG55P <input type="checkbox"/> KM55P	2 modules with hatch  Cover for item K4142A

Note: if replacing only the cover with door, order the following codes: KG/KM/KW04P

EXAMPLE: FUNCTION & COVER COLOUR CHOICE

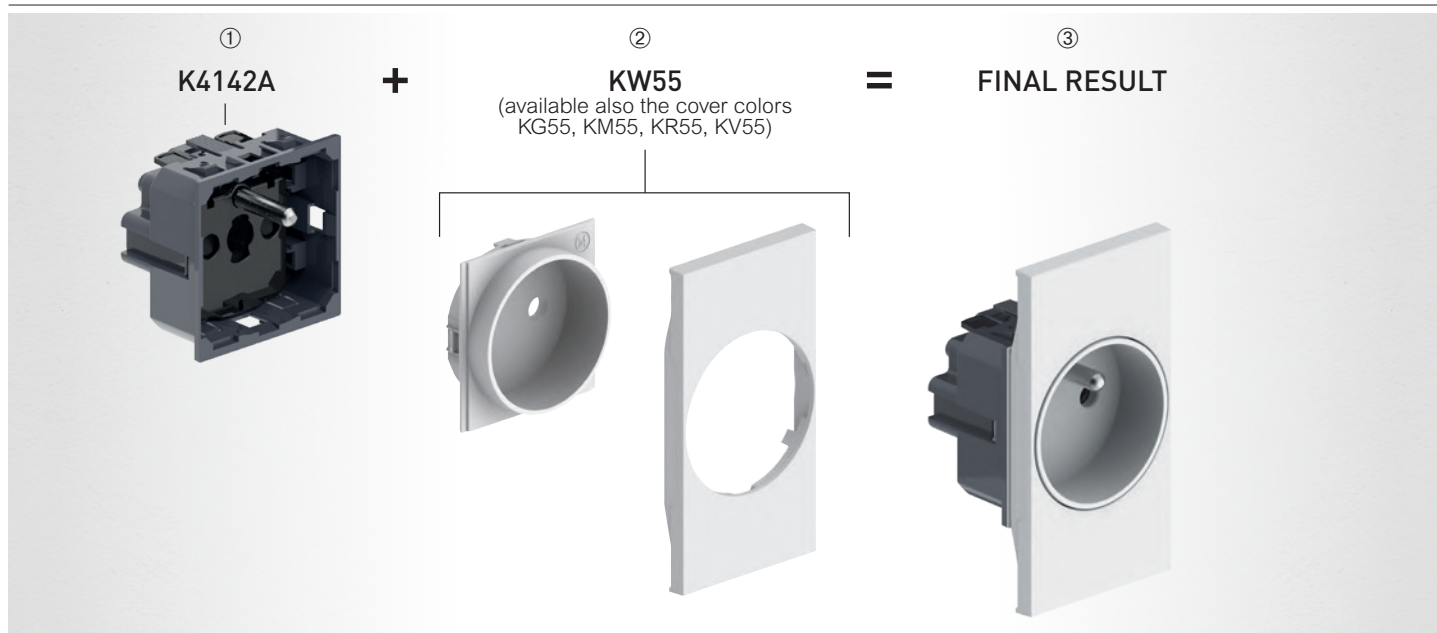

Traditional electrical system

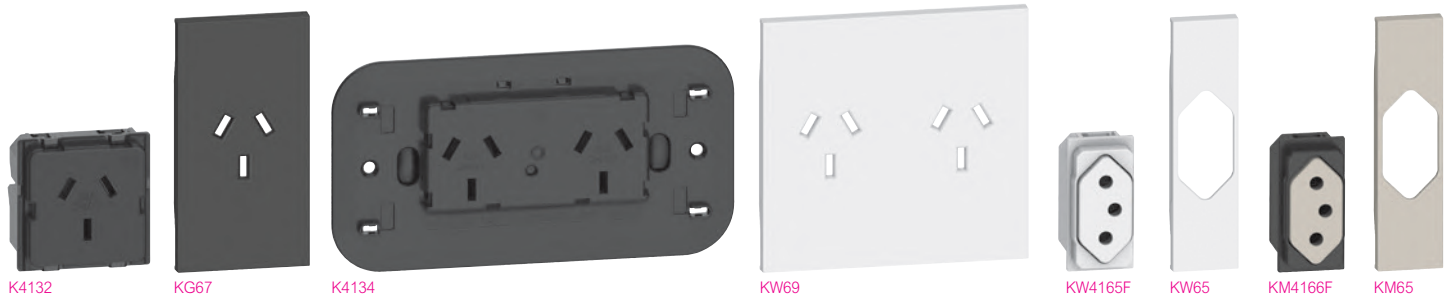

Indian, australain, chinese and brasilian standard sockets

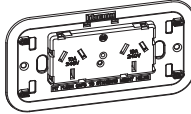

Devices to be completed with appropriate cover as indicated below

Item	Australian standard sockets
<input type="radio"/> K4132	 2P+E 10 A 250 V~ Australian std. socket - safety socket SGPO, shuttered and auto switched - 2 modules
<input type="radio"/> K4134	 2P+E 10 A 250 V~ Australian std. socket - duplex - 3 modules

Item	Cover for australian standard sockets
<input type="checkbox"/> KW67 <input checked="" type="checkbox"/> KG67	 Cover for Item K4132
<input type="checkbox"/> KW69 <input checked="" type="checkbox"/> KG69	 Cover for Item K4134

Item	Brasilian standard socket
<input type="checkbox"/> KW4165F <input checked="" type="checkbox"/> KG4165F <input type="checkbox"/> KM4165F	 2P+E 10A 250V~ flat brasilian std. socket - shuttered contact tubes - 1 module
<input type="checkbox"/> KW4166F <input checked="" type="checkbox"/> KG4166F <input type="checkbox"/> KM4166F	 2P+E 20A 250V~ flat brasilian std. socket - shuttered contact tubes - 1 module

Item	Cover for brasilian standard sockets
<input type="checkbox"/> KW65 <input checked="" type="checkbox"/> KG65 <input type="checkbox"/> KM65	 Cover for Item KW4165F, KW4166F Cover for Item KG4165F, KG4166F Cover for Item KM4165F, KM4166F

White colour cover

Black colour cover





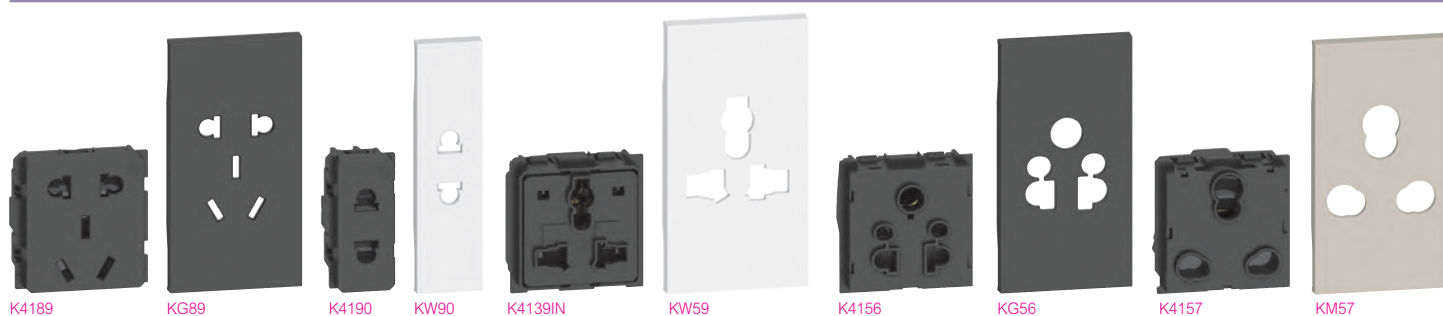

Sand colour cover





Neutral item (without cover)



Items in red colour: New products



Devices to be completed with appropriate cover as indicated below

Item	China standard sockets
<input type="radio"/> K4181	 2P+E 16A 250V~ chinese std. socket - shuttered contact tubes - 2 modules
<input type="radio"/> K4189	 2P+E 10A 250V~ chinese std. socket + 2P 16A Euro American std. Socket - shuttered contact tubes - 2 modules
<input type="radio"/> K4190	 2P+E 10A 250V~ chinese std. - 1 module
Indian standard socket	
<input type="radio"/> K4139IN	 Indian multistandard socket - 2 modules
<input type="radio"/> K4156	 2P+E 6/10A 240V~ and 15A 127V~ Indian and Euro-US std. socket - shuttered contact tubes - 2 modules
<input type="radio"/> K4157	 2P+E 6/16A 240V~ Indian std. Combined socket - shuttered contact tubes - 2 modules

Item	Cover for chinese standard sockets
3 modules	
<input type="checkbox"/> KW81 <input checked="" type="checkbox"/> KG81	 Cover for Item K4181
<input type="checkbox"/> KW89 <input checked="" type="checkbox"/> KG89	 Cover for Item K4189
<input type="checkbox"/> KW89S <input checked="" type="checkbox"/> KG89S	 Cover for Item K4189
<input type="checkbox"/> KW90 <input checked="" type="checkbox"/> KG90	 Cover for Item K4190







Item	Cover for indian standard sockets
<input type="checkbox"/> KW59 <input checked="" type="checkbox"/> KG59 <input type="checkbox"/> KM59	 Cover for Item K4139IN
<input type="checkbox"/> KW56 <input checked="" type="checkbox"/> KG56 <input type="checkbox"/> KM56	 Cover for Item K4156
<input type="checkbox"/> KW57 <input checked="" type="checkbox"/> KG57 <input type="checkbox"/> KM57	 Cover for Item K4157



Traditional electrical system

USB and wireless chargers



Devices to be completed with appropriate cover as indicated below

Item	USB charger
<input type="radio"/> K4285C1	 5 Vdc type A USB charger only for charging electronic devices up to 1,500 mA - 110-230 V 50-60 Hz DIRECT power supply - 1 module
<input type="radio"/> K4285C2	 5 Vdc type A USB charger for quick charge of one single electronic device up to 3,000 mA or simultaneous charging of two devices up to 1,500 mA - 110-230 V 50-60 Hz DIRECT power supply - 2 modules
<input type="radio"/> K4286C1	 5 Vdc type C USB charger only for charging electronic devices up to 1,500 mA - 110-230 V 50-60 Hz DIRECT power supply - 1 module
<input type="radio"/> K4286C2	 5 Vdc type C USB charger for quick charge of one single electronic device up to 3,000 mA or simultaneous charging of two devices up to 1,500 mA - 110-230 V 50-60 Hz DIRECT power supply - 2 modules
<input type="radio"/> K4287C2	 5 Vdc type A and C USB charger for quick charge of single electronic devices up to 3,000 mA or simultaneous charging of two devices up to 1,500 mA - 110-230 V 50-60 Hz DIRECT power supply - 2 modules
<input type="radio"/> K4288C2	 Type C USB charger for quick charge up to 30W. It allows the fast charge of portable devices (PC, tablets, smartphones) based on 3.0 Power Delivery technology and devices not based on 3.0 Power Delivery (tablets, smartphones). Energy efficiency level VI TUV. Standby consumption 0,6W. Output voltage 5 - 9 - 12 - 15 - 20 V - 2 modules.

Item	Cover for USB charger
<input type="checkbox"/> KW10C <input checked="" type="checkbox"/> KG10C <input type="checkbox"/> KM10C	1 module  Cover for item K4285C1 and K4286C1
<input type="checkbox"/> KW12C <input checked="" type="checkbox"/> KG12C <input type="checkbox"/> KM12C	2 modules  Cover for item K4285C2, K4286C2, K4287C2, K4288C2

Item	Induction charger
<input type="checkbox"/> KW4286CW2 <input checked="" type="checkbox"/> KG4286CW2 <input type="checkbox"/> KM4286CW2	 It allows the quick and wireless charging of smartphones with induction receiver up to 1,000 mA (compliant with WPC Qi standard). The antislip support surface is inclined by 10°. Antitheft lock function. Energy performance >85%. Equipped with a 3.000 mA type-A USB port for the powering of a second device - 12 W. Possibility of simultaneous recharging of two devices, up to 500 mA wirelessly, and up to 1,200 mA through the USB port. Dimension 136.5 x 70 x 56.5 mm. The cover of the selected colour is supplied in the same box as the charger.

White colour cover Black colour cover Sand colour cover Neutral item (without cover)

Items in red colour: New products

Traditional electrical system

USB charger with socket - German standard



KW4141USB



KG4141USB



KM4141USB



KW63





KG63



KM63

Devices to be completed with appropriate cover as indicated below

Item	USB charger with socket outlet
<input type="checkbox"/> KW4141USB	 <p>German standard electric socket with integrated USB charger. Socket 2 P+E 16 A 250 V~ - protected tulip contacts - side earth contact. 5 Vdc type C USB charger for charging electronic devices up to 1,500 mA. Integrated with a 2-module support, it can be installed instead of an existing socket in a 40 mm deep box. Screw fixing and connection using automatic clamps.</p>
<input checked="" type="checkbox"/> KG4141USB	
<input type="checkbox"/> KM4141USB	

Item	Cover for USB charger
2 modules	
<input type="checkbox"/> KW63	 <p>Cover for items KW4141USB, KG4141USB, KM4141USB</p>
<input checked="" type="checkbox"/> KG63	
<input type="checkbox"/> KM63	

White colour cover

Black colour cover

Sand colour cover

Neutral item (without cover)

Items in red colour: New products

Traditional electrical system

USB charger with socket - French/belgian standard



Devices to be completed with appropriate cover as indicated below

Item	USB charger with socket outlet
<input type="checkbox"/> KW4142USB	 <p>French/belgian standard flat electric socket with integrated USB charger. Socket 2 P+E 16 A 250 V~ - protected tulip contacts. When the plug is inserted the socket surface slides inside the casing; it returns to its initial position when the plug is taken out. 5 Vdc type C USB charger for charging electronic devices up to 1,500 mA. Integrated with a 2-module support, it can be installed instead of an existing socket in a 40 mm deep box. Screw fixing and connection using automatic clamps.</p>
<input checked="" type="checkbox"/> KG4142USB	
<input type="checkbox"/> KM4142USB	

Item	Cover for USB charger
2 modules	
<input type="checkbox"/> KW62	 <p>Cover for items KW4142USB, KG4142USB, KM4142USB</p>
<input checked="" type="checkbox"/> KG62	
<input type="checkbox"/> KM62	

White colour cover

Black colour cover

Sand colour cover

Neutral item (without cover)

Items in red colour: New products

Traditional electrical system

USB charger with socket



KW4185AA



KG4185AC





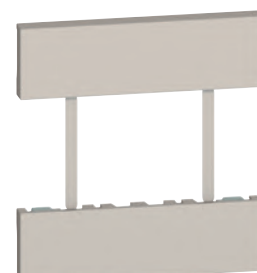

KM4188AC

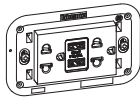

KM52

Devices to be completed with appropriate cover as indicated below

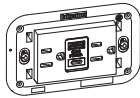
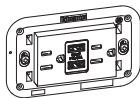
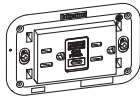
Item	USB charger with socket european/american std.	Item	Cover for USB charger with socket european/american std.
<input type="checkbox"/> KW4185AA <input checked="" type="checkbox"/> KG4185AA <input type="checkbox"/> KM4185AA	 <p>Euro american standard 2 P+E 16 A 127/250 V~ universal duplex socket - shielded tulip contacts. 5 Vdc type A USB charger for quick charge of one single electronic device up to 3,100 mA or simultaneous charging of two devices up to 1,500 mA - 110-230 V 50-60 Hz DIRECT power supply - 3 modules</p>	<input type="checkbox"/> KW52 <input checked="" type="checkbox"/> KG52 <input type="checkbox"/> KM52	<p>2 modules</p>  <p>Cover for Item KW4185AA, KW4185AC, KW4188AA, KW4188AC</p>  <p>Cover for Item KG4185AA, KG4185AC, KG4188AA, KG4188AC</p>  <p>Cover for Item KM4185AA, KM4185AC, KM4188AA, KM4188AC</p>
<input type="checkbox"/> KW4185AC <input checked="" type="checkbox"/> KG4185AC <input type="checkbox"/> KM4185AC	 <p>Euro american standard 2 P+E 16 A 127/250 V~ universal duplex socket - shielded tulip contacts. 5 Vdc type A and C USB charger for quick charge of single electronic devices up to 3,100 mA or simultaneous charging of two devices up to 1,500 mA - 110-230 V 50-60 Hz DIRECT power supply - 3 modules</p>		
<input type="checkbox"/> KW4188AA <input checked="" type="checkbox"/> KG4188AA <input type="checkbox"/> KM4188AA	 <p>American standard 2 P+E 15 A 127/250 V~ universal duplex socket - shielded tulip contacts. 5 Vdc type A USB charger for quick charge of one single electronic device up to 3,100 mA or simultaneous charging of two devices up to 1,500 mA - 110-230 V 50-60 Hz DIRECT power supply - 3 modules</p>		
<input type="checkbox"/> KW4188AC <input checked="" type="checkbox"/> KG4188AC <input type="checkbox"/> KM4188AC	 <p>American standard 2 P+E 15 A 127/250 V~ universal duplex socket - shielded tulip contacts. 5 Vdc type A and C USB charger for quick charge of single electronic devices up to 3,100 mA or simultaneous charging of two devices up to 1,500 mA - 110-230 V 50-60 Hz DIRECT power supply - 3 modules</p>		

White colour cover

Black colour cover

Sand colour cover

Neutral item (without cover)







Items in red colour: New products



Traditional electrical system

TV sockets







Devices to be completed with appropriate cover as indicated below



Item	TV socket 1 module
<input type="radio"/> K4202D	 Direct coaxial socket for single-user aerial systems, including central remote powered systems and single-user central satellite systems with current and signal transfer for the selection of the channels - shielded connection clamps with captive screws - Diam. 9.5 mm - male connector - 1 module
<input type="radio"/> K4202CN	 Chinese TV socket - 1 module
<input type="radio"/> K4202P14	 Passthrough coaxial socket, -14 dB attenuation, for centralised aerial systems, including central remote powered systems and centralised satellite systems with current and signal transfer for the selection of the channels - shielded connection clamps with captive screws - Diam. 9.5 mm - male connector - 1 module
<input type="radio"/> K4202P10	 Terminal passthrough coaxial socket, 10dB attenuation, for centralised aerial systems, including central remote powered systems and centralised satellite systems with current and signal transfer for the selection of the channels; shielded connection clamps with captive screws - Diam. 9.5 mm - male connector - 75 Ω incorporated impedance final adapter - 1 module
<input type="radio"/> K4202F	 Type F TV coaxial connector - impedance 75 Ω - screw hook - 1 module
<input type="radio"/> K4214D	 Direct demixed coaxial socket for single-user aerial systems, also remote powered and shunting centralised and for single-user / shunting centralised satellite systems with current and signal transfer for the selection of the channels, Ø 9.5 mm male TV connector - type F SAT connector - 1 module

Item	Cover for TV socket 1 module
<input type="checkbox"/> KW08 <input type="checkbox"/> KG08 <input type="checkbox"/> KM08	 1 module Cover for item K4202D, K4202P14, K4202P10, K4202F and K4202CN
<input type="checkbox"/> KW09 <input type="checkbox"/> KG09 <input type="checkbox"/> KM09	 Cover for item K4214D
<input type="checkbox"/> KW08M2 <input type="checkbox"/> KG08M2 <input type="checkbox"/> KM08M2	 2 modules Cover for item K4202D, K4202P14, K4202P10 and K4202F

White colour cover

Black colour cover

Item	TV socket 2 modules
<input type="radio"/> K4211M2C	 TV-RD socket for cable operator - Double coaxial shunted socket for TV and FM-LMC reception - Ø 9,5mm - Belgium (Telenet operator) - 2 modules
<input type="radio"/> K4217M2D	 Star demixed TV-SAT sockets for DVB-T, cablecast and satellite installation UHD TV, 4GLTE compatible. For distribution of TV & Radio signals. Recommended coaxial cable: 17 VATC - Meet EN 50083 and EN 50083-2 European directive. - TV male connector (Ø9.5 mm) - SAT F type connector - TV: 5-68/120-862 MHz; R: 87.5 - 108 MHz; - SAT: 950-2400 MHz - attenuation 1.5 dB - 2 modules
<input type="radio"/> K4217MP14	 Passthrough demixed TV-SAT sockets for DVB-T, cablecast and satellite installation UHD TV, 4GLTE compatible. For distribution of TV & Radio signals. Meet EN 50083 and EN 50083-2 European directive - TV male connector (Ø9.5 mm) - SAT F type connector - TV: 5-68/120-862 MHz; R: 87.5 - 108 MHz; - SAT: 950-2400 MHz - attenuation 14 dB - 2 modules
<input type="radio"/> K4217M2P10	 Terminal demixed TV-SAT sockets for DVB-T, cablecast and satellite installation UHD TV, 4GLTE compatible. For distribution of TV & Radio signals. Meet EN 50083 and EN 50083-2 European directive - TV male connector (Ø9.5 mm) - SAT F type connector - TV: 5-68/120-862 MHz; R: 87.5 - 108 MHz; - SAT: 950-2400 MHz - attenuation 10 dB - 2 modules
<input type="radio"/> K4210M2D	 Star demixed TV-R-SAT sockets for DVB-T, cablecast and satellite installation UHD TV, 4GLTE compatible. For distribution of TV & Radio signals. Recommended coaxial cable: 17 VATC - Meet EN 50083 and EN 50083-2 European directive. - TV male connector (Ø 9.5 mm) - R female connector (Ø9.5 mm) - SAT F type connector - TV: 5-68/120-862 MHz; R: 87.5 - 108 MHz; - SAT: 950-2400 MHz - attenuation 1.5 dB - 2 modules

Item	Cover for TV socket 2 modules
<input type="checkbox"/> KW25M2 <input type="checkbox"/> KG25M2 <input type="checkbox"/> KM25M2	 2 modules Cover for item K4211M2C, K4217M2D, K4217MP14 and K4217M2P10
<input type="checkbox"/> KW26M2 <input type="checkbox"/> KG26M2 <input type="checkbox"/> KM26M2	 Cover for item K4210M2D

Item	Cover for TV-SAT sockets - no brand BTicino
<input type="checkbox"/> KW4212 <input type="checkbox"/> KG4212 <input type="checkbox"/> KM4212	 2 modules Cover for TV-SAT sockets

Neutral item (without cover)





Items in red colour: New products

Traditional electrical system

RJ connectors for data, telephony and for optical fiber



Devices to be completed with appropriate cover as indicated below



Item	RJ45 connectors	
	Connectors for data/telephony transmission These connectors can be used for 4-pair signal transmission systems - 1 module	
<input type="checkbox"/> KW4279C5E <input checked="" type="checkbox"/> KG4279C5E <input type="checkbox"/> KM4279C5E		Category: 5E UTP Type of connection: TOOLLESS IDC
<input type="checkbox"/> KW4279C6 <input checked="" type="checkbox"/> KG4279C6 <input type="checkbox"/> KM4279C6		Category: 6 UTP Type of connection: TOOLLESS IDC
<input type="checkbox"/> KW4279C6S <input checked="" type="checkbox"/> KG4279C6S <input type="checkbox"/> KM4279C6S		Category: 6 STP Type of connection: TOOLLESS IDC
<input type="checkbox"/> KW4279C6A <input checked="" type="checkbox"/> KG4279C6A <input type="checkbox"/> KM4279C6A		Category: 6A UTP Type of connection: TOOLLESS IDC
<input type="checkbox"/> KW4279C6AS <input checked="" type="checkbox"/> KG4279C6AS <input type="checkbox"/> KM4279C6AS		Category: 6A STP Type of connection: TOOLLESS IDC

Item	RJ11 connectors	
	These connectors are designed to meet the needs linked with telephonic interconnections - 1 module	
<input type="checkbox"/> KW4258RJ11 <input checked="" type="checkbox"/> KG4258RJ11 <input type="checkbox"/> KM4258RJ11		Category: RJ11 Type of connection: K10

Item	Telephone socket standard BS
<input type="checkbox"/> K4238	Telephone socket standard BS - 1 module

Item	Connector for optical fiber
<input type="checkbox"/> K4268SCA	Coupling connector for optical fiber - SC cable socket - duplex - 2 modules

Item	KEYSTONE
<input type="checkbox"/> KW07K <input checked="" type="checkbox"/> KG07K <input type="checkbox"/> KM07K	Keystone connectors adapter - 1 module

Item	Cover for RJ45, RJ11 connectors and Keystons adapters
<input type="checkbox"/> KW07 <input checked="" type="checkbox"/> KG07 <input type="checkbox"/> KM07	1 module  Cover for all the RJ45 and RJ11 connectors
<input type="checkbox"/> KW07M2 <input checked="" type="checkbox"/> KG07M2 <input type="checkbox"/> KM07M2	2 modules  Cover for all the RJ45 and RJ11 connectors

Item	Cover for telephone socket standard BS
<input type="checkbox"/> KW20 <input checked="" type="checkbox"/> KG20 <input type="checkbox"/> KM20	2 modules  Cover for item K4238

Item	Cover for optical fiber connector
<input type="checkbox"/> KW13M2 <input checked="" type="checkbox"/> KG13M2 <input type="checkbox"/> KM13M2	2 modules  Cover for item K4268SCA

Traditional electrical system
audio video connectors



Devices to be completed with appropriate cover as indicated below

Item	Audio Connector
<input type="checkbox"/> KW4269R <input checked="" type="checkbox"/> KG4269R <input type="checkbox"/> KM4269R	Double RCA module - 1 module
<input type="checkbox"/> KW4294 <input checked="" type="checkbox"/> KG4294 <input type="checkbox"/> KM4294	Home cinema speaker connector - 1 module
<input type="checkbox"/> K4284P	Pre-connected HDMI 1.4 connector - 1 module
<input type="checkbox"/> K4285P	Pre-connected type A USB connector - 1 module

Item	Cover for audio and A/V connectors
<input type="checkbox"/> KW07 <input checked="" type="checkbox"/> KG07 <input type="checkbox"/> KM07	1 module Cover for item KW4269R, KG4269R, KM4269R, KW4294, KG4294 and KM4294
<input type="checkbox"/> KW14 <input checked="" type="checkbox"/> KG14 <input type="checkbox"/> KM14	Cover for item K4284P
<input type="checkbox"/> KW10P <input checked="" type="checkbox"/> KG10P <input type="checkbox"/> KM10P	Cover for item K4285P
<input type="checkbox"/> KW07M2 <input checked="" type="checkbox"/> KG07M2 <input type="checkbox"/> KM07M2	2 modules Cover for item KW4269R, KG4269R, KM4269R, KW4294, KG4294 and KM4294

White colour cover

Black colour cover

Sand colour cover

Neutral item (without cover)

Items in red colour: New products

Traditional electrical system

luminous and audible notification



Devices to be completed with appropriate cover as indicated below

Item	Bells and buzzer
○ K4351V230	Bells
	230 V~ bronze bell - 12 VA - 80 dB - 1 module
	127 V~ bronze bell - 8 VA - 80 dB - 1 module
○ K4351V127	12 V~ bronze bell - 8 VA - 80 dB - 1 module
○ K4351V12	Electronic bell - 3 different sounds - with front volume adjustment - 12 Va.c.-d.c. power supply - 2 modules
○ K4355V12	Buzzer
○ K4356V230	230 V~ buzzer - 12 VA - 80 dB - 1 module
○ K4356V127	127 V~ buzzer - 12 VA - 80 dB - 1 module
○ K4356V12	12 V~ buzzer - 12 VA - 80 dB - 1 module
○ K4371	Pilot lamp
	Lampholder for pilot lamp with transparent diffuser, to be completed with LED item K4743V230 (white) and/or item K4743V230R (red). Two operating mode: - 1 luminous signaling (to be completed with cover KW/KG/KM08) - 2 luminous signaling (to be completed with cover KW/KG/KM09)

Réf.	Cover for bell and buzzer
<input type="checkbox"/> KW15 <input checked="" type="checkbox"/> KG15 <input type="checkbox"/> KM15	1 module Cover for item K4351V230, K4351V127, K4351V12, K4356V230, K4356V127 and K4356V12
	2 modules Cover for item K4355V12
	<input type="checkbox"/> KW15M2 <input checked="" type="checkbox"/> KG15M2 <input type="checkbox"/> KM15M2
<input type="checkbox"/> KW08 <input checked="" type="checkbox"/> KG08 <input type="checkbox"/> KM08	Cover for pilot lamp
	1 module Cover for item K4371 (one luminous signal) Cover for item K4371 (two luminous signals)
<input type="checkbox"/> KW09 <input checked="" type="checkbox"/> KG09 <input type="checkbox"/> KM09	

White colour cover

Black colour cover

Sand colour cover

Neutral item (without cover)

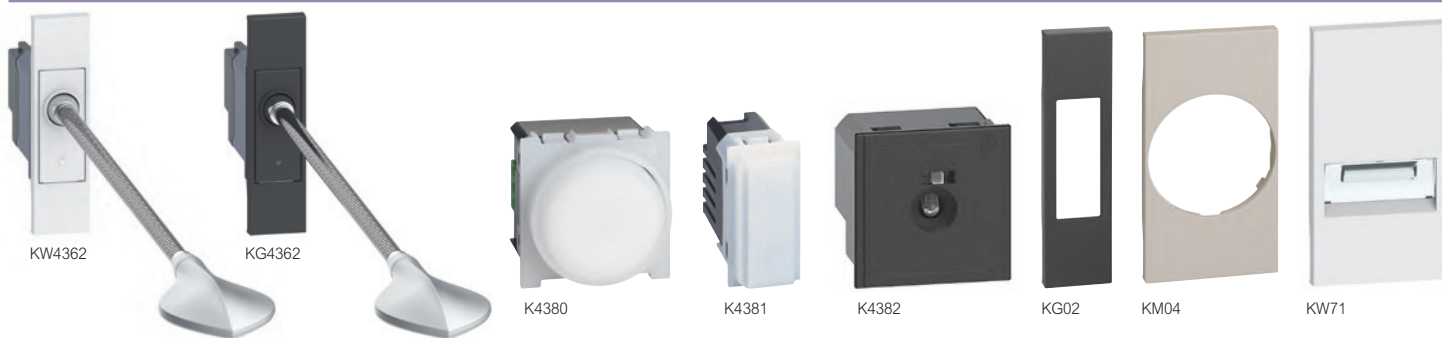

Items in red colour: New products

**Traditional electrical system
lighting**





Devices to be completed with appropriate cover as indicated below

Item	Reading lamp
<input type="checkbox"/> KW4362	 <p>It is installed at the bedhead giving directional lighting. It has a flexible arm so that the lighting arm can be directed. The brightness can be dimmed by pressing the integrated ON/OFF control for a long time. It can also be connected to a remote control and, if necessary, the integrated control can be disabled with a 30 sec. press. - LED lamp - 3W consumption - Luminous flux 110 lumen (equivalent to 15 W incandescence) - Life 40,000 hours - 1 module (flush-mounted). Cover supplied with device.</p>
<input checked="" type="checkbox"/> KG4362	
<input type="checkbox"/> KM4362	

Item	Torch and safety LED lamp
<input type="checkbox"/> K4380	 <p>Removable and rechargeable torch with automatic switching on device - it lights up automatically when there is a power cut - push&pull pull-out system complete with recharge base - white light LED with high luminous efficiency - ON/OFF switch and SPOT pushbutton to increase the brightness when necessary - interchangeable Ni-MH batteries without "memory" effect - 2 hour life - low consumption in stand-by 0.4 W - 230 V~ power supply - 2 modules</p>
<input type="checkbox"/> 4380NB	
<input type="checkbox"/> K4381	
	 <p>Spare batteries for removable torch</p>
	 <p>LED safety lamp with automatic operation when there is a power cut. 230 V~ 50/60 Hz - power consumption 2.5 VA (0.1 W) - rechargeable non-replaceable NiMH 3.6 V 140 mAh battery - complete charge in 48 hours - life 2 hours - maximum cable section 1 x 1.5 mm² - light intensity 2400 mcd - angle of emission 120° - not pull-out - 1 module</p>

Item	Step marker lamp
<input type="checkbox"/> K4382	 <p>Step marker lamps with white light LEDs - 127/230 V~ - on-off switch - 0.15-0.5 W - 2 modules</p>

Item	Cover for lighting functions
<input type="checkbox"/> KW02	1 module  <p>Cover for item K4381</p>
<input checked="" type="checkbox"/> KG02	
<input type="checkbox"/> KM02	
<input type="checkbox"/> KW04	2 modules  <p>Cover for item K4380</p>
<input checked="" type="checkbox"/> KG04	
<input type="checkbox"/> KM04	
<input type="checkbox"/> KW71	 <p>Cover for item K4382</p>
<input checked="" type="checkbox"/> KG71	
<input type="checkbox"/> KM71	

White colour cover Black colour cover Sand colour cover Neutral item (without cover)

Items in red colour: New products

Traditional electrical system

functions for hotel room



Devices to be completed with appropriate cover as indicated below

Item	Key card switches
○ K4549	Key card switch for the power supply inside the hotel room - slot light with built-in lamp - 30 second switch-off delay - power supply 230 V~. The completion of the light point requires two "half-module blanking modules" (item K4949) at the sides of the badge holder.
○ K4548	Key card switch for the power supply inside the hotel room - slot light with built-in lamp - 30 second switch-off delay - power supply 230 V~ - with RFID technology recognition. The completion of the light point requires two "half-module blanking modules" (item K4949) at the sides of the badge holder.
Off-door controls	
○ K4027H	1P 10 AX, 250 V~ changeover switch, double-key 1-0-2 for Hotel, LIT - 1 module (The LED is replaceable with item K4743V230RG)
○ K4027V127H	As above, 127 V~ (The LED is replaceable with Item K4373V127RG)
○ K4373	Lampholder with two built-in LEDs, green and red. Can be used as out of room visual signal with double notification: do not disturb and make up the room - The LEDs cannot be replaced - 127/ 230 V~ power supply - 1 module
USB charger	
○ K4288C2	Type C USB charger for quick charge up to 30W. It allows the fast charge of portable devices (PC, tablets, smartphones) based on 3.0 Power Delivery technology and devices not based on 3.0 Power Delivery (tablets, smartphones). Energy efficiency level VI TUV. Standby consumption 0,6W. Output voltage 5 - 9 - 12 - 15 - 20 V - 2 modules.
Shaver sockets	
<input type="checkbox"/> KW4177 <input checked="" type="checkbox"/> KG4177 <input type="checkbox"/> KM4177	Shaver socket with insulation transformer - input voltage 230 V~ 50/60 Hz - output voltage 115/230 V~ 20 VA The cover of the selected colour is supplied in the same box as the shaver socket - 3 modules

Item	Cover for functions for hotel
1 module	
<input type="checkbox"/> KW06H <input checked="" type="checkbox"/> KG06H <input type="checkbox"/> KM06H	Cover for item K4027H and K4027V127H
<input type="checkbox"/> KW11H <input checked="" type="checkbox"/> KG11H <input type="checkbox"/> KM11H	Cover for item K4373
2 modules	
<input type="checkbox"/> KW22M2 <input checked="" type="checkbox"/> KG22M2 <input type="checkbox"/> KM22M2	Cover for item K4549 et K4548
3 modules	
<input type="checkbox"/> KW22 <input checked="" type="checkbox"/> KG22 <input type="checkbox"/> KM22	Cover for item K4549 et K4548
Cover for USB charger	
2 modules	
<input type="checkbox"/> KW12C <input checked="" type="checkbox"/> KG12C <input type="checkbox"/> KM12C	Cover for item K4288C2

White colour cover

Black colour cover

Sand colour cover

○ Neutral item (without cover)

Items in red colour: New products

Traditional electrical system

LED and blanking modules



Devices to be completed with appropriate cover as indicated below

Item	LED for control and socket lighting
	LED for backlighting of the following "basic control devices": K4001, K4001A, K4003, K4003A, K4005, K4005A, K4001M2A, K4003M2A, K4005M2A, KW4002, KG4002, KM4002 et K4034
K4743V230T	white LED - 230 V~ - high luminosity for daytime load notification
K4743V127T	white LED - 127 V~ - high luminosity for daytime load notification
K4743V230R	red LED - 230 V~ - high luminosity for daytime load notification
LN4743/230T	white LED - 230 V~ - night signal
LN4743/12T	white LED - 12/24 V~ - night signal
H4743/230B	blue LED - 230 V~ - night signal
H4743/12B	blue LED - 12/24 V~ - night signal
	Replacement LED for changeover switch (hotel control)
K4743V230RG	Red/green LED - 230 V~ for item K4027H
K4743V127RG	Red/green LED - 127 V~ for item K4027V127H

Item	Blanking modules
K4950	Blanking module - 1 module
K4953	Blanking module with output Ø 9 mm - 1 module

Item	Installation accessory
K4949	1/2 module blanking module - it does not require the cover

Item	Cover for Blanking modules
<input type="checkbox"/> KW00 <input checked="" type="checkbox"/> KG00 <input type="checkbox"/> KM00	1 module Cover for item K4950
<input type="checkbox"/> KW08 <input checked="" type="checkbox"/> KG08 <input type="checkbox"/> KM08	Cover for item K4953
<input type="checkbox"/> KW00M2 <input checked="" type="checkbox"/> KG00M2 <input type="checkbox"/> KM00M2	2 modules Cover for item K4950

EXAMPLES OF LED CONNECTION ON A SWITCH

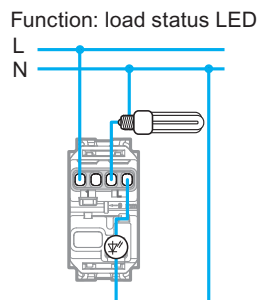
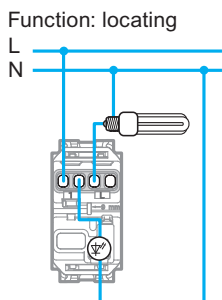

Control backlighting led connection

Note for the connection of 230 V.a.c. LEDs for the backlighting of control devices: when LEDs are fitted to help locate the control itself, it must be taken into account that energy saving and fluorescent lamps do not allow in series connection of the LED on the load. It is therefore necessary to also take a neutral conductor near the control, so that the LED may be connected directly between phase and neutral, and will always be on.







White colour cover Black colour cover Sand colour cover Neutral item (without cover)

Items in red colour: New products

Living Now

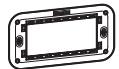
support frames and IP44 housing



Item	Supports
K4702	 2-module support frame supplied with protective shell
K4703	 3-module support frame supplied with protective shell
K4703AU	 3-module support frame Australia
K4704	 4-module support frame supplied with protective shell
K4706	 6-module support frame supplied with protective shell
500/00	 Pair of 35 mm screws for the fastening of the supports to boxes installed below the plaster work.
K8102	 Support for the installation of the electrified frame item KW8102P1, KG8102P1, KM8102P1 in 2 module box
KA4902	 Accessorie for 2 module support frame - to be used on Indian standard installations

Item	IP44 housing
26603	 IP44 protection cover (guaranteed when closed). Ideal for installation where an IP44 protection degree is required. Fully compatible with all ranges, both BTicino and other brands. It is made with high-quality material which guarantees long-term sealing against all weather conditions. It can be installed on Italian standard 3-module flush mounted box
503CG	Protective cover for flush mounted box item 503E - to be used during finishing masonry works
503EV	Internal resin separator - for box item 503E - for the separation of data and power circuits
503EC	Finishing cover for flush mounted box item 503E - to be used when the box is used as a junction box - can be painted
504EC	Cover as above, for boxes item 504E
506EC	Cover as above, for boxes item 506E
503DE	Internal resin separator - for box item 504E
503ED	Coupling for boxes items 502E, 503E, 504E (horizontal and vertical) and for box 506L (only vertical). It cannot be used with the box extension

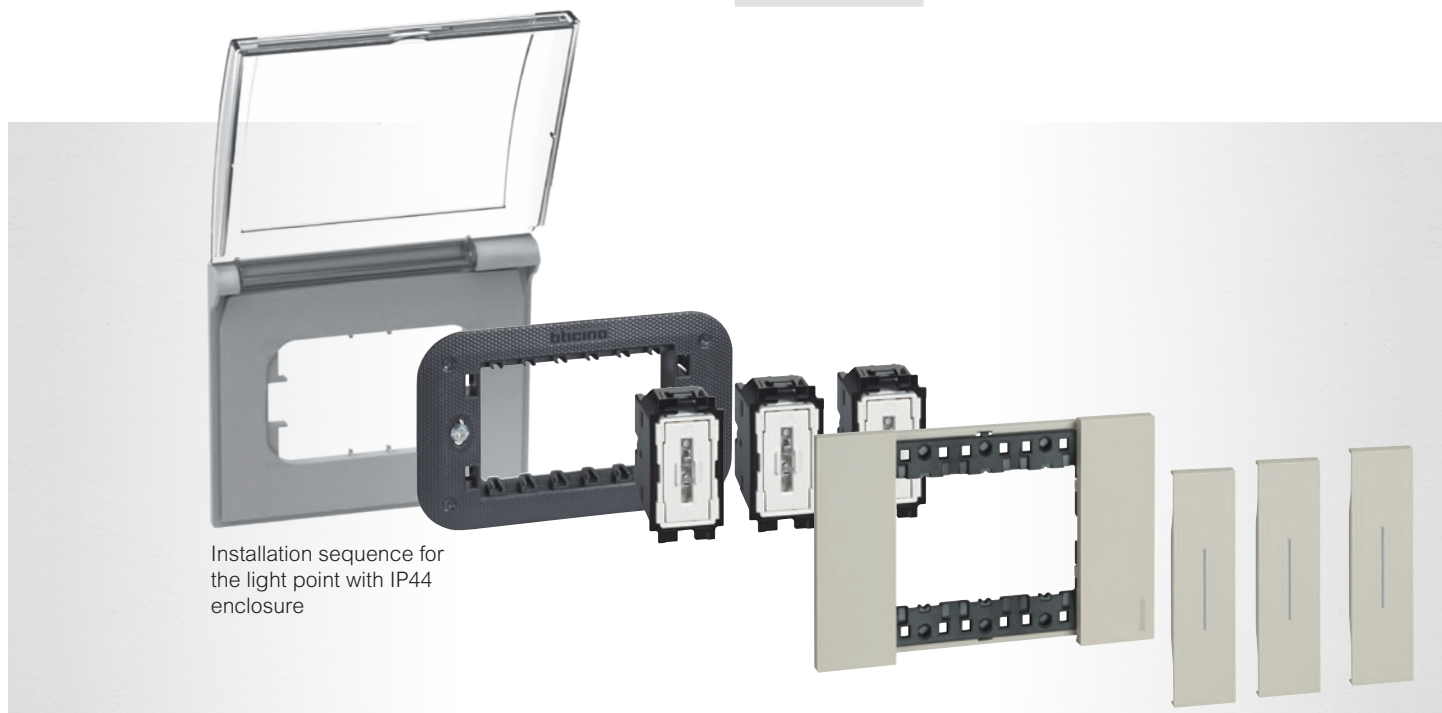

Installation sequence for the light point with IP44 enclosure

Traditional electrical system

lightable cover with symbols, for items:

K4001, K4003, K4004, K4004L, K4004LB, K4005, K4034

COVER	Item	Cover for the comand of heating, ventilation, boiler
 KW01PN	KW01PN KG01PN KM01PN	Cover 1 module. Heating comand White Black Sand
		
		
 KW01RN	KW01RN KG01RN KM01RN	Cover 1 module. Ventilation comand White Black Sand
		
		
 KW01SN	KW01SN KG01SN KM01SN	Cover 1 module. Boiler comand White Black Sand
		
		
 KW01M2PN	KW01M2PN KG01M2PN KM01M2PN	Cover 2 module. Heating comand White Black Sand
		
		
 KW01M2RN	KW01M2RN KG01M2RN KM01M2RN	Cover 2 module. Ventilation comand White Black Sand
		
		
 KW01M2SN	KW01M2SN KG01M2SN KM01M2SN	Cover 2 module. Boiler comand White Black Sand
		
		



Living Now WITH Netatmo



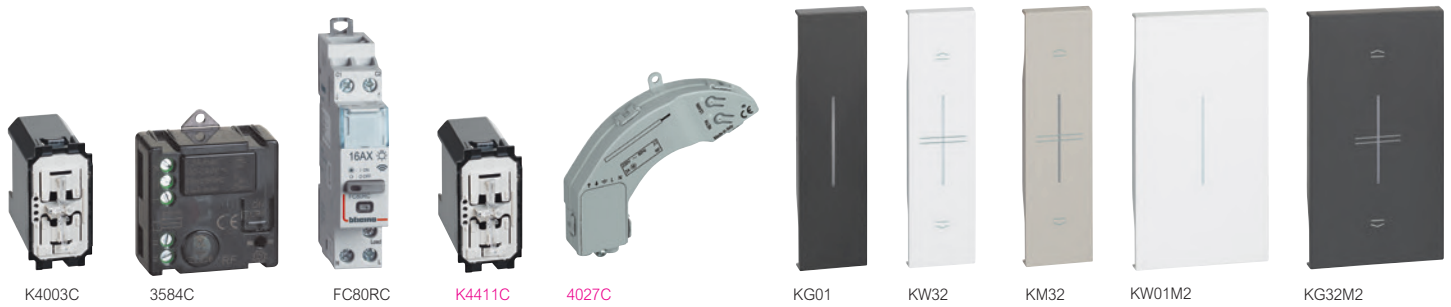



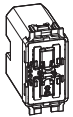
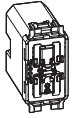

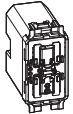
SMART ELECTRICAL SYSTEM

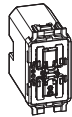

Devices to be completed with appropriate cover as indicated below

Item	Connected devices for light
○ K4001C	 <p>Connected one-way switch. It controls the lights locally or remotely. It can be installed like a traditional two-way switch and is compatible with all loads with max. power 250 W. It has a blue LED, which can be configured using the Home + Control App for the localisation and load status functions. It can be associated to one or more wireless controls. Caution: neutral connection is necessary. Power supply 110-230 V~ - 1 module</p>
○ K4003C	 <p>Connected 2ways switch. It allows to control lights locally or remotely. The connected 2ways switch has the same installation and usability of a traditional 2ways switch and it is compatible with all loads with max power 250 W. It is equipped with a blue LED light used always on for localization modality or on, when the light is on for the load status modality. It can be associated with "wireless light switches". Caution: Must be connected to the neutral. Power supply 110-230 V~ - 1 module</p>
○ 3584C	 <p>Connected lighting micromodule. It allows to control lights locally or remotely. It is compatible with all loads with max power 300 W. It can be connected to one or more traditional push-button or associated with "wireless light switches". It is installed as a traditional relet in the box (behind the button) or in derivation boxes. Caution: Must be connected to the neutral. Power supply 110-230 V~</p>
○ FC80RC	 <p>DIN switchboard light device for loads with absorption In= 16 A. Equipped with a meter measuring the current absorbed by the load and contacts for control with up to 10 pushbuttons. 1 DIN module. Power supply 110-230 V~</p>
○ K4411C	 <p>Dimmer/switch. It allows to control lights locally or remotely, with the dimmer functionality that can be activated from APP Home+Control. It has the same installation and usability of a traditional switch and it is compatible with all loads (LED, halogen) with max power 150 W at 230 V (or 75 W at 110 V). It is equipped with a blue LED light used for localization modality or load status modality, configurable by APP. It can be connected to one or more traditional push-button or associated with "wireless light switches". Caution: Must be connected to the neutral. Power supply 110-230 V~ - 1 module</p>

Item	Connected devices for shutters
○ K4027C	 <p>Connected rolling shutter switch - It allows the control of a shutter locally or remotely. Compatible with all standard rolling shutter motors (with a mechanical or electromechanical stop and max power 500 VA) controlled by a wired shutter switch (switching of the same motor power supply). Not compatible with motors for radio-controlled or pulse-controlled roller shutters. It can be associated with one or more wireless commands. Caution: Must be connected to the neutral. Power supply 110-230 V~ - 1 module</p>
○ 4027C	 <p>Connected micromodule for shutters. Associated to one or more shutter wireless controls, it controls a shutter locally or remotely. Compatible with all standard shutter motors (with mechanical or electronic limit switch and maximum power 500 VA), controlled by a wired shutter changeover switch (changeover with the same power supply as the motor). Not compatible with radio controlled or pulse controlled shutter motors. It can be installed in the existing shutter box with no need of masonry works. Power supply 110-230 V~</p>
<p>Cover</p> <p>1 module</p> <ul style="list-style-type: none"> <input type="checkbox"/> KW01 <input checked="" type="checkbox"/> KG01 <input type="checkbox"/> KM01  Cover for item K4001C, K4003C and K4411C <ul style="list-style-type: none"> <input type="checkbox"/> KW32 <input checked="" type="checkbox"/> KG32 <input type="checkbox"/> KM32  Cover for item K4027C	
<p>2 modules</p> <ul style="list-style-type: none"> <input type="checkbox"/> KW01M2 <input checked="" type="checkbox"/> KG01M2 <input type="checkbox"/> KM01M2  Cover for item K4001C and K4003C <ul style="list-style-type: none"> <input type="checkbox"/> KW32M2 <input checked="" type="checkbox"/> KG32M2 <input type="checkbox"/> KM32M2  Cover for item K4027C	



App HOME + CONTROL for management of connected devices



Note: for the use of the connected devices, the gateway, item K4500C, item K4510C or item. FC80GT, must be installed as part of the system.

White colour cover Black colour cover Sand colour cover ○ Neutral item (without cover)

Items in red colour: New products







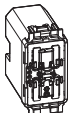

Living Now with Netatmo smart electrical system - MODULAR VERSION

wireless controls for light and shutter





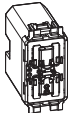











Devices to be completed with appropriate cover as indicated below

Item	Wireless controls for light
<input type="radio"/> K4003CWI	 <p>Wireless light switch. It allows the ON / OFF and dimming control of one or more connected devices for the lighting control. It can be installed in any flush-mounted box without any wiring. The battery can be replaced without removing it from the supporting frame. Integrated LED for low battery indication. Powered by battery 3V type CR2032 (supplied) with an autonomy of 8 years - 1 module</p>
<input type="radio"/> K4003CW	 <p>Wireless light switch. It allows the ON / OFF and dimming control of one or more connected devices for the lighting control. Surface installation with repositionable stickers (supplied) or onto a flush mounting box. Integrated LED for low battery indication. Powered by battery 3V type CR2032 (supplied) with an autonomy of 8 years - 2 modules</p>
<input type="radio"/> K4003DCW	 <p>Wireless light switch. It is equipped with two buttons to control two different connected devices for lights. Each single button can be associated with one or more devices. Surface installation with repositionable stickers (supplied) or onto a flush mounting box. Integrated LED for low battery indication. Powered by battery 3V type CR2032 (supplied) with an autonomy of 8 years - 2 modules</p>
<input type="radio"/> 3577C	 <p>Wireless module for mechanical switch. It allows to change a two-way switch or a traditional pushbutton into a wireless light control for ON/OFF control of one or more devices connected for light control. The small size allows the installation in the flush mounted box. CR2032 type 3V power battery with 8 year expected life supplied (as standard).</p>



Item	Wireless controls for shutter
<input type="radio"/> K4027CWI	 <p>Rolling shutter wireless switch - It allows the control of one or more connected rolling shutter switches. It can be installed in any flush-mounted box without any wiring. The battery can be replaced without removing it from the supporting frame. Integrated LED for low battery indication. Powered by battery 3V type CR2032 (supplied) with an autonomy of 8 years - 1 module</p>
<input type="radio"/> K4027CW	 <p>Rolling shutter wireless switch - It allows the control of one or more connected rolling shutter switches. Surface installation with repositionable stickers (supplied) or onto a flush mounting box. Integrated LED for low battery indication. Powered by battery 3V type CR2032 (supplied) with an autonomy of 8 years - 2 modules</p>



Item	Motion sensor wireless
<input type="radio"/> 3585C	 <p>It controls one or more devices connected for light control. Infrared detection with angle of 140°. Distance of the adjustable sensor from 2 to 8 m. Switch off delay with 1 to 30 min adjustable delay time and 1 to 1000 lux brightness threshold. Test possible with a 5 sec. delay Recommended assembly height: 2.5 m. Optimum distance between 2 detectors: 6 m. For indoor and outdoor use (IP44). Supplied with 2 1.5V AA batteries for power supply.</p>

Item	Cover
<input type="checkbox"/> KW01	1 module  Cover for item K4003CWI  Cover for item K4027CWI
<input checked="" type="checkbox"/> KG01	
<input type="checkbox"/> KM01	
<input type="checkbox"/> KW32	2 modules  Cover for item K4003CW  Cover for item K4003DCW  Cover for item K4027CW
<input checked="" type="checkbox"/> KG32	
<input type="checkbox"/> KM32	
<input type="checkbox"/> KW42M2	2 modules  Cover for item K4003CW  Cover for item K4003DCW  Cover for item K4027CW
<input checked="" type="checkbox"/> KG42M2	
<input type="checkbox"/> KM42M2	
<input type="checkbox"/> KW36M2	2 modules  Cover for item K4003CW  Cover for item K4003DCW  Cover for item K4027CW
<input checked="" type="checkbox"/> KG36M2	
<input type="checkbox"/> KM36M2	
<input type="checkbox"/> KW43M2	2 modules  Cover for item K4003CW  Cover for item K4003DCW  Cover for item K4027CW
<input checked="" type="checkbox"/> KG43M2	
<input type="checkbox"/> KM43M2	

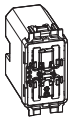



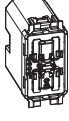



Devices to be completed with appropriate cover as indicated below

Item	Wireless Home/Away scenario controls
<input type="radio"/> K4570CWI	 <p>Home / Away wireless switch. It is equipped with 2 buttons for activating Home / Away scenarios. Scenarios can be customized by the Home + Control app. It can be installed in any flush-mounted box without any wiring. The battery can be replaced without removing it from the supporting frame. Integrated LED for low battery indication. Powered by battery 3V type CR2032 (supplied) with an autonomy of 8 years - 1 module</p>
<input type="radio"/> K4570CW	 <p>Home / Away wireless switch. It is equipped with 2 buttons for activating Home / Away scenarios. Scenarios can be customized by the Home + Control app. Surface installation with repositionable stickers (supplied) or onto a flush mounting box. Integrated LED for low battery indication. Powered by battery 3V type CR2032 (supplied) with an autonomy of 8 years - 2 modules</p>

Item	Wireless Wake Up / Sleep scenario controls
<input type="radio"/> K4574CWI	 <p>It is equipped with 2 buttons for activating Wake Up / Sleep scenarios. Scenarios can be customized by the Home + Control app. It can be installed in any flush-mounted box without any wiring. The battery can be replaced without removing it from the supporting frame. Integrated LED for low battery indication. Powered by battery 3V type CR2032 (supplied) with an autonomy of 8 years - 1 module</p>
<input type="radio"/> K4574CW	 <p>It is equipped with 2 buttons for activating Wake Up / Sleep scenarios. Scenarios can be customized by the Home + Control app. Surface installation with repositionable stickers (supplied) or onto a flush mounting box. Integrated LED for low battery indication. Powered by battery 3V type CR2032 (supplied) with an autonomy of 8 years - 2 modules</p>

Item	Wireless 4 scenarios control
<input type="radio"/> K4575CW	 <p>It's equipped with 4 buttons for activating of scenarios 1,2,3 and 4. Scenarios can be customized by the Home+ Control app. Surface installation with repositionable stickers (supplied) or onto a flushmounting box. Integrated LED for low battery indication. Powered by battery 3V type CR2032 (supplied) with an autonomy of 8 years - 2 modules.</p>

Item	Pocket remote control 4 scenarios
<input type="radio"/> 3528C	 <p>It allows to add a wireless remote control in your system. Is equipped with 4 keys for the activation of the 1,2,3 and 4 scenarios. The scenarios can be activated and customized by the Home + Control app. Integrated LED for low battery indication. Powered by battery 3V type CR2032 (supplied) with an autonomy of 8 years.</p>

Item	Cover
<input type="checkbox"/> KW40 <input checked="" type="checkbox"/> KG40 <input type="checkbox"/> KM40	1 module  Cover for item K4570CWI  Cover for item K4574CWI
<input type="checkbox"/> KW41 <input checked="" type="checkbox"/> KG41 <input type="checkbox"/> KM41	2 modules  Cover for item K4570CW  Cover for item K4574CW  Cover for item K4575CW
<input type="checkbox"/> KW40M2 <input checked="" type="checkbox"/> KG40M2 <input type="checkbox"/> KM40M2	
<input type="checkbox"/> KW41M2 <input checked="" type="checkbox"/> KG41M2 <input type="checkbox"/> KM41M2	
<input type="checkbox"/> KW37M2 <input checked="" type="checkbox"/> KG37M2 <input type="checkbox"/> KM37M2	











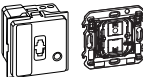

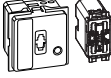
Living Now with Netatmo smart electrical system - MODULAR VERSION

wireless controls and controls for energy management and gateway





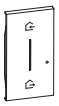

Devices to be completed with appropriate cover as indicated below



Item	Connected module for energy management	Item	Gateway
○ K4531C	 <p>Connected socket module - wiring to a power outlet, allows to remotely control appliances and check the consumption (instantaneous, daily, monthly). It is also possible to receive notifications in case of anomalous consumption. The connected socket module is compatible with any device electric and large appliances up to 16 A 3680 W max. (protected against overloads). It is equipped with a LED light lit in blue when it is on. This option can be enabled or disabled in the "Home+Control" app. It can be associated with "wireless light switches". Power supply 110-230 V~ - 1 module</p>	○ K4500C	 <p>Gateway. This pack enables to create a connected installation in the home. It can be used to control lighting, roller shutters and electrical equipment plugged into connected sockets: - using your smartphone and the Home + Control app - using voice assistants - from the general control at the entrance to your home Supplied with the Home/Away wireless master switch required for the association procedure of all connected devices. Power supply 110-230 V~ - 2 modules</p>
○ 4141PC	 <p>Mobile connected German standard power outlet -plug&play-. Directly connected to an existing socket, it allows remote control of all the connected electrical appliances. It also monitors the instantaneous, daily and monthly consumption. Compatible with all the devices with power up to 16 A 3680 W (with overload protection). It can be associated to wireless light controls. Power supply 110-230 V~ - 1 module</p>	○ K4510C	 <p>Gateway as above. Supplied with the flush-mounted Home/Away wireless master switch 1 module required for the association procedure of all connected devices. Power supply 110-230 VA - 2 modules</p>
○ 4142PC	 <p>As above French/belgian standard socket.</p>	○ FC80GT	 <p>Gateway as above for DIN switchboard. Supplied without wireless In&Out master scenario control item K4570CW. - 2.5 DIN modules.</p>
○ FC80CC	 <p>Connected contactor for single-phase and/or three-phase loads with maximum absorption In= 20 A. With meter for the measurement of the current absorbed by the load. Power supply 110-230 V~ - 1 DIN module</p>	<p>Cover for item K4531C</p> <p>1 module</p> <p>□ KW31 ■ KG31 □ KM31</p>  <p>Cover for item K4531C</p>	
○ F20T60A	 <p>Connected DIN meter. It allows to measure the energy consumption of the house electric installation (instantaneous, daily, monthly). It is also possible to receive notifications in case of exceeded the maximum power provided by your contract to avoid possible black-out. A toroid is provided to read the current. Power supply 110-230 V~ - 1 DIN module</p>	<p>Cover required for the gateway</p> <p>2 modules</p> <p>□ KW30M2 ■ KG30M2 □ KM30M2</p>  <p>Cover for item K4500C in combination with the relative colored cover item KW40M2, KG40M2, KM40M2 and for item K4510C in combination with the relative colored cover item KW40, KG40, KM40</p>	
○ FC80GCS	 <p>Connected DIN load management module for the monitoring of the consumptions of the whole electric system, the powering or disconnection of the loads, and the setting of scenarios with priority or non-priority loads. When the maximum intended power is reached, the non-priority loads are temporarily disconnected to avoid black-outs. A toroid for the current reading is provided Power supply 110-230 V~ - 1 DIN module</p>	<p>Cover for the gateway scenario control</p> <p>1 module</p> <p>□ KW40 ■ KG40 □ KM40</p>  <p>Cover for item K4570CWI (scenario control in the gateway item K4510C)</p> <p>2 modules</p> <p>□ KW40M2 ■ KG40M2 □ KM40M2</p>  <p>Cover for item K4570CW (scenario control in the gateway item K4500C)</p>	



Devices to be completed with appropriate cover as indicated below

Item	Connected devices for light
○ 3584C	 <p>Connected lighting micromodule. It allows to control lights locally or remotely. It is compatible with all loads with max power 300 W. It can be connected to one or more traditional push-button or associated with "wireless light switches". It is installed as a traditional rele in the box (behind the button) or in derivation boxes. Caution: Must be connected to the neutral. Power supply 110-230 V~</p>
○ FC80RC	 <p>DIN switchboard light device for loads with absorption In= 16 A. Equipped with a meter measuring the current absorbed by the load and contacts for control with up to 10 pushbuttons.. Power supply 110-230 V~ - 1 DIN module</p>
○ K4411CM2	 <p>Dimmer/switch without neutral. It allows to control lights locally or remotely, with the dimmer functionality that can be activated from APP Home+Control. It has the same installation and usability of a traditional switch and it is compatible with all loads (LED, halogen) with power 5-300 W at 230 V. It s equiped with a blue LED light used for localization modality or load status modality, configurable by APP. It can be connected associated with "wireless light switches". It doesn't require connection to the neutral, it comes with an active compensator. Power supply 110-230 V~ - 2 modules</p>

Item	Connected devices for shutters
○ K4027CM2	 <p>Connected shutter control for the local or remote control of a shutter. Compatible with all standard shutter motors (with mechanical or electronic limit switch and maximum power 500 VA), controlled by a wired shutter changeover switch (changeover with the same power supply as the motor). Not compatible with radio controlled or pulse controlled shutter motors. It can be associated to one or more wireless controls. Power supply 110-230 V~ - 2 modules</p>
○ 4027C	 <p>Connected micromodule for shutters. Associated to one or more shutter wireless controls, it controls a shutter locally or remotely. Compatible with all standard shutter motors (with mechanical or electronic limit switch and maximum power 500 VA), controlled by a wired shutter changeover switch (changeover with the same power supply as the motor). Not compatible with radio controlled or pulse controlled shutter motors. It can be installed in the existing shutter box with no need of masonry works. Power supply 110-230 V~</p>

Item	Cover
<input type="checkbox"/> KW01M2 <input checked="" type="checkbox"/> KG01M2 <input type="checkbox"/> KM01M2	<p>2 modules</p>  Cover for item K4411CM2
<input type="checkbox"/> KW43M2 <input checked="" type="checkbox"/> KG43M2 <input type="checkbox"/> KM43M2	 Cover for item K4027CM2



App HOME + CONTROL for management of connected devices



Note: for the use of the connected devices, the gateway, item **K4500C**, item **K4510C** or item. **FC80GT**, must be installed as part of the system.

White colour cover Black colour cover Sand colour cover ○ Neutral item (without cover)

Items in red colour: New products



Living Now with Netatmo smart electrical system - EUROPEAN VERSION

wireless controls for light and shutter



K4003CW



K4003DCW



3585C





KW36M2







KW32M2

Devices to be completed with appropriate cover as indicated below

Item	Wireless controls for light
<input type="radio"/> K4003CW	 <p>Wireless light switch. It allows the control of one or more connected devices for the lighting control. Surface installation with repositionable stickers (supplied) or onto a flush mounting box. Integrated LED for low battery indication. Powered by battery 3V type CR2032 (supplied) with an autonomy of 8 years - 2 modules</p>
<input type="radio"/> K4003DCW	 <p>Wireless light switch. It is equipped with two buttons to control two different connected devices for lights. Each single button can be associated with one or more devices. Surface installation with repositionable stickers (supplied) or onto a flush mounting box. Integrated LED for low battery indication. Powered by battery 3V type CR2032 (supplied) with an autonomy of 8 years - 2 modules</p>

Item	Wireless controls for shutter
<input type="radio"/> K4027CW	 <p>Rolling shutter wireless switch - It allows the control of one or more connected rolling shutter switches. Surface installation with repositionable stickers (supplied) or onto a flush mounting box. Integrated LED for low battery indication. Powered by battery 3V type CR2032 (supplied) with an autonomy of 8 years - 2 modules</p>

Item	Motion sensor wireless
<input type="radio"/> 3585C	 <p>It controls one or more devices connected for light control. Infrared detection with angle of 140°. Distance of the adjustable sensor from 2 to 8 m. Switch off delay with 1 to 30 min adjustable delay time and 1 to 1000 lux brightness threshold. Test possible with a 5 sec. delay Recommended assembly height: 2.5 m. Optimum distance between 2 detectors: 6 m. For indoor and outdoor use (IP44). Supplied with 2 1.5V AA batteries for power supply.</p>

Item	Cover
<input type="checkbox"/> KW42M2 <input checked="" type="checkbox"/> KG42M2 <input type="checkbox"/> KM42M2	<p>2 modules</p>  Cover for item K4003CW
<input type="checkbox"/> KW36M2 <input checked="" type="checkbox"/> KG36M2 <input type="checkbox"/> KM36M2	 Cover for item K4003DCW
<input type="checkbox"/> KW43M2 <input checked="" type="checkbox"/> KG43M2 <input type="checkbox"/> KM43M2	 Cover for item K4027CW

White colour cover

Black colour cover

Sand colour cover

Neutral item (without cover)

Items in red colour: New products

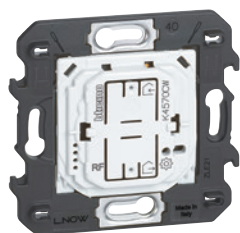

K4570CW

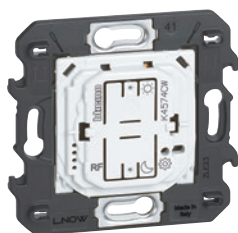

K4574CW



3528C



KG40M2



KM40M2



KW41M2





KG37M2



Devices to be completed with appropriate cover as indicated below

Item	Wireless Home/Away scenario controls
○ K4570CW	 <p>Home / Away wireless switch. It is equipped with 2 buttons for activating Home / Away scenarios Scenarios can be customized by the Home + Control app. Surface installation with repositionable stickers (supplied) or onto a flush mounting box. Integrated LED for low battery indication. Powered by battery 3V type CR2032 (supplied) with an autonomy of 8 years - 2 modules</p>

○ K4574CW	 <p>Wireless Wake Up / Sleep scenario controls It is equipped with 2 buttons for activating Wake Up / Sleep scenarios. Scenarios can be customized by the Home + Control app. Surface installation with repositionable stickers (supplied) or onto a flush mounting box. Integrated LED for low battery indication. Powered by battery 3V type CR2032 (supplied) with an autonomy of 8 years - 2 modules</p>
-----------	--

○ K4575CW	 <p>Wireless 4 scenarios control It's equipped with 4 buttons for activating of scenarios 1,2,3 and 4. Scenarios can be customized by the Home+ Control app. Surface installation with repositionable stickers (supplied) or onto a flushmounting box. Integrated LED for low battery indication. Powered by battery 3V type CR2032 (supplied) with an autonomy of 8 years - 2 modules.</p>
-----------	---

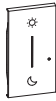













○ 3528C	 <p>Pocket remote control 4 scenarios It allows to add a wireless remote control in your system. Is equipped with 4 keys for the activation of the 1,2,3 and 4 scenarios. The scenarios can be activated and customized by the Home + Control app. Integrated LED for low battery indication. Powered by battery 3V type CR2032 (supplied) with an autonomy of 8 years.</p>
---------	---

Item	Cover
2 modules	
<input type="checkbox"/> KW40M2 <input checked="" type="checkbox"/> KG40M2 <input type="checkbox"/> KM40M2	 Cover for item K4570CW
<input type="checkbox"/> KW41M2 <input checked="" type="checkbox"/> KG41M2 <input type="checkbox"/> KM41M2	 Cover for item K4574CW
<input type="checkbox"/> KW37M2 <input checked="" type="checkbox"/> KG37M2 <input type="checkbox"/> KM37M2	 Cover for item K4575CW

Living Now with Netatmo smart electrical system - EUROPEAN VERSION
 wireless controls and controls for energy management and gateway
 eliot™



Devices to be completed with appropriate cover as indicated below

Item	Connected module for energy management	Item	Gateway
<input type="radio"/> 4141PC	 <p>Mobile connected German standard power outlet -plug&play-. Directly connected to an existing socket, it allows remote control of all the connected electrical appliances. It also monitors the instantaneous, daily and monthly consumption. Compatible with all the devices with power up to 16 A 3680 W (with overload protection). It can be associated to wireless light controls. Power supply 110-230 V~</p>	<input type="radio"/> K4500C	  <p>Gateway. This pack enables to create a connected installation in the home. It can be used to control lighting, roller shutters and electrical equipment plugged into connected sockets: - using your smartphone and the Home + Control app - using voice assistants - from the general control at the entrance to your home Supplied with the Home/Away wireless master switch required for the association procedure of all connected devices. Power supply 110-230 V~ - 2 modules</p>
<input type="radio"/> 4142PC	 <p>As above French/belgian standard socket</p>	<input type="radio"/> FC80GT	 <p>Gateway as above for DIN switchboard. Supplied without wireless In&Out master scenario control item K4570CW. - 2.5 DIN modules.</p>
<input type="radio"/> FC80CC	 <p>Connected contactor for single-phase and/or three-phase loads with maximum absorption In= 20 A. With meter for the measurement of the current absorbed by the load. Power supply 110-230 V~ - 1 DIN module</p>	<p>Cover required for the gateway 2 modules</p> <p><input type="checkbox"/> KW30M2 <input checked="" type="checkbox"/> KG30M2 <input type="checkbox"/> KM30M2</p>  <p>Cover for item K4500C in combination with the relative colored cover item KW40M2, KG40M2, KM40M2 and for item K4510C in combination with the relative colored cover item KW40, KG40, KM40.</p>	
<input type="radio"/> F20T60A	 <p>Smart DIN meter. It allows to measure the electrical energy consumption of the entire single-phase system of the house (instantaneous, daily, monthly) and of the single electrical power lines. It allows the reception of notifications in case of reaching the maximum power foreseen by the contract to avoid annoying black-outs. A toroid is supplied to measure the input current. Power supply 100-240 V~ - 1 DIN module. (Only for single-phase systems).</p>	<p>Cover for the gateway scenario control 2 modules</p> <p><input type="checkbox"/> KW40M2 <input checked="" type="checkbox"/> KG40M2 <input type="checkbox"/> KM40M2</p>  <p>Cover for item K4570CW (scenario control in the gateway item K4500C)</p>	
<input type="radio"/> FC80GCS	 <p>Connected DIN load management module for the monitoring of the consumptions of the whole electric system, the powering or disconnection of the loads, and the setting of scenarios with priority or non-priority loads. When the maximum intended power is reached, the non-priority loads are temporarily disconnected to avoid black-outs. A toroid for the current reading is provided Power supply 110-230 V~ - 1 DIN module</p>	<p>Cover for connected socket 2 modules</p> <p><input type="checkbox"/> KW34M2 <input checked="" type="checkbox"/> KG34M2 <input type="checkbox"/> KM34M2</p>  <p>Cover for item KW4141AC Cover for item KG4141AC Cover for item KM4141AC</p> <p><input type="checkbox"/> KW35M2 <input checked="" type="checkbox"/> KG35M2 <input type="checkbox"/> KM35M2</p>  <p>Cover for item KW4142AC Cover for item KG4142AC Cover for item KM4142AC</p>	
<input type="checkbox"/> KW4141AC <input checked="" type="checkbox"/> KG4141AC <input type="checkbox"/> KM4141AC	 <p>Connected socket 2P+E 16 A 250 Va.c. German standard connected socket. It allows remote control of electric devices and also to monitor their consumption (instantaneous, daily, monthly). It is also possible to receive notifications that can be configured. Compatible with all the electric devices with power up to 16 A 3680W (with overload protection). Integrated with a 2-module support, it can be installed instead of an existing socket in a 40 mm deep box. Screw fixing and connection using automatic clamps It has a blue LED that lights up when the socket is ON and that can be configured by means of the Home + Control APP. It can be associated to one or more wireless light controls. Power supply 110-230 V~</p>		
<input type="checkbox"/> KW4142AC <input checked="" type="checkbox"/> KG4142AC <input type="checkbox"/> KM4142AC	 <p>As above French/belgian standard socket</p>		

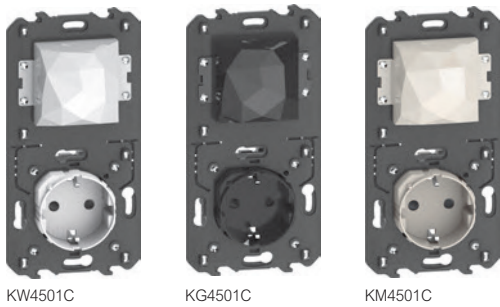

- Item
- KW4501C
 - KG4501C
 - KM4501C

Gateway with socket



The gateway creates a connected installation in the home. It can be used to control lights, shutters, and electric appliances plugged into connected sockets:

- using the smartphone and the Home + Control app
- using the voice assistants

- from the general control at the home entrance. It integrates a 2P+E 16 A 250 V~ German standard connected socket for the remote control of electric devices and to monitor their consumption (instantaneous, daily, monthly). Compatible with all the electric devices with power up to 16 A 3680W (with overload protection). It can be installed instead of an existing socket in a 40 mm deep box. Screw fixing and connection using automatic clamps

It has a blue LED that lights up when the socket is ON and that can be configured by means of the Home + Control APP. It can be associated to one or more wireless light controls. It is also supplied with wireless master IN&OUT scenario control, required for the association of all connected devices.

Power supply 110-230 V~

- Item
- KW51
 - KG51
 - KM51

Cover required for the gateway with socket

2 modules



Cover required for all the gateways with sockets, in addition to the 2 modules cover for the socket part

- Item
- KW34M2
 - KG34M2
 - KM34M2
-
- KW35M2
 - KG35M2
 - KM35M2

Cover for the socket

2 modules



Cover for item KW4501C
Cover for item KG4501C
Cover for item KM4501C



Cover for item KW4502C
Cover for item KG4502C
Cover for item KM4502C

EXAMPLE: FUNCTION, COVER PLATE & COVER COLOUR CHOICE

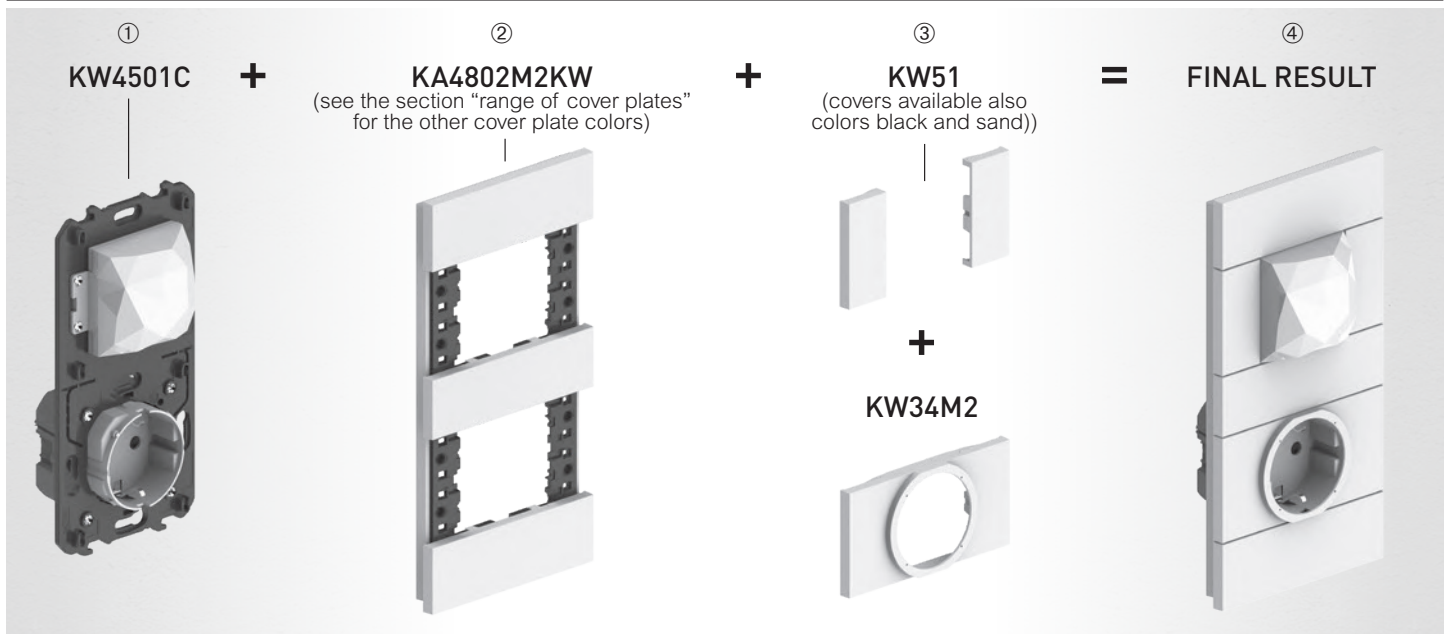

Living Now with Netatmo smart electrical system - EUROPEAN VERSION

gateway with socket



KW4502C KG4502C KM4502C

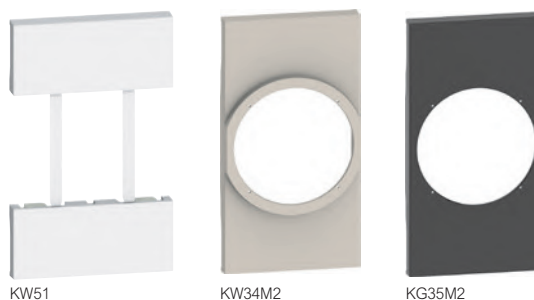

KW51 KW34M2 KG35M2

Item

- KW4502C
- KG4502C
- KM4502C

Gateway with socket



The gateway creates a connected installation in the home. It can be used to control lights, shutters, and electric appliances plugged into connected sockets:

- using the smartphone and the Home + Control app
- using the voice assistants

- from the general control at the home entrance. It integrates a 2P+E 16 A 250 V~. French/belgian standard connected socket for the remote control of electric devices and to monitor their consumption (instantaneous, daily, monthly). Compatible with all the electric devices with power up to 16 A 3680W (with overload protection). It can be installed instead of an existing socket in a 40 mm deep box. Screw fixing and connection using automatic clamps

It has a blue LED that lights up when the socket is ON and that can be configured by means of the Home + Control APP. It can be associated to one or more wireless light controls. It is also supplied with wireless master IN&OUT scenario control, required for the association of all connected devices.

Power supply 110-230 V~

Item

- KW51
- KG51
- KM51

Cover required for the gateway with socket

2 modules



Cover required for all the gateways with sockets, in addition to the 2 modules cover for the socket part

Cover for the socket

2 modules

- KW34M2
- KG34M2
- KM34M2



Cover for item KW4501C
Cover for item KG4501C
Cover for item KM4501C

- KW35M2
- KG35M2
- KM35M2



Cover for item KW4502C
Cover for item KG4502C
Cover for item KM4502C

EXAMPLE: FUNCTION, COVER PLATE & COVER COLOUR CHOICE

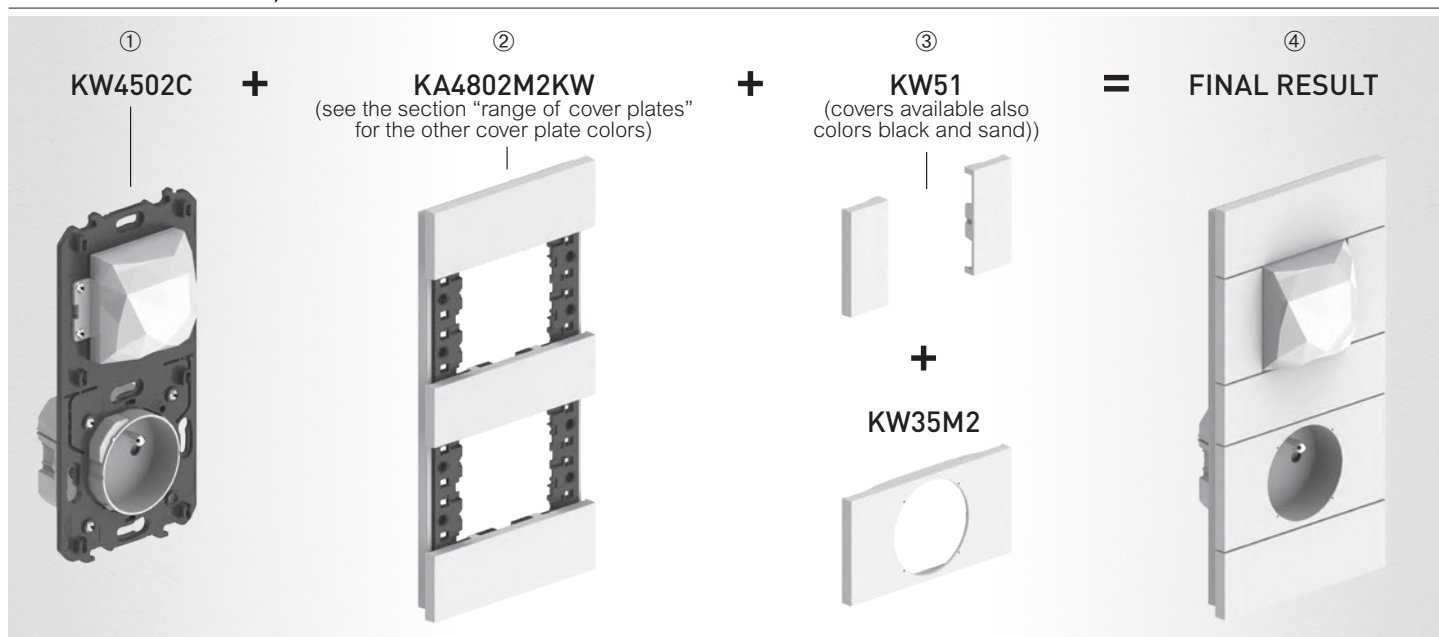

① KW4502C + ② KA4802M2KW (see the section "range of cover plates" for the other cover plate colors) + ③ KW51 (covers available also colors black and sand) + KW35M2 = ④ FINAL RESULT



XW8002



XG8002



XM8002



XW8002W

The Smarter with Netatmo connected thermostat, together with the dedicated HOME+CONTROL APP, is a device which allows you to adjust and monitor the temperature in the rooms precisely and accurately; all the programming and most of the functions are performed simply and intuitively using the APP. Thanks to its Wi-Fi connection, Smarter with Netatmo can be programmed and controlled remotely; it can also display the temperature and humidity measured in the room. The temperature level can be set locally for manual operation and the Boost mode can be activated. The Boost forces the switching on of the system for a limited time (30, 60 or 90 minutes) independent of the measured and programmed temperature.

It's also possible to set a different temperature in each room of the house for the maximum comfort, thanks to its compatibility with Netatmo smart radiator valves.

Smarter with Netatmo can also be controlled with Google, Amazon Alexa and Apple Home Kit voice assistants.



Features:

- 110 ÷ 230 V~, 50/60 Hz power supply;
- 2 W max absorption;
- maximum cable section 1 x 1.5mm²;
- temperature measurement 5 ÷ 40°C;
- temperature set-point 5 ÷ 40°C,
- increase of 0.5°C;
- 1-contact output in switching free of potential 5(2)A.

Types of installation:

- flush mounted, on boxes item 503E or 500 (for item 500 use the wall dowels)
- plasterboard, on boxes 2 module and 3 module

It is available in three colours: white (XW8002), sand (XM8002) and black (XG8002).

Item	Connected thermostats	
<input type="checkbox"/> XW8002 <input checked="" type="checkbox"/> XG8002 <input type="checkbox"/> XM8002		White Black Sand
XW8002W		Features: as XW8002. Installation on the wall, using screws and dowels suitable for the installation surface (brickwork, plasterboard, tiles etc.). It is only available in white.



App HOME + CONTROL for management of connected devices



Living Now



MyHOME_Up system



Item **Control server using the app**

○ MYHOMESERVER1  Server to associate devices during the system starting-up and for the local and remote management of the functions by the user with the specific MyHOME_Up application for Android and iOS smartphones or tablets.

○ MHSERVERKIT **MyHOMEServer1 KIT**  Kit containing MyHOMEServer1 and Access Point for communication between the MyHome_Up system to which it is connected, and a smartphone or tablet where the MyHome-Up App is installed.

Note: For the details of the products managed by MyHome_Up and the compatible products, see the corresponding guide.

Item **SCS/DALI interface**

○ F429  DALI dimmer, 8 independent outputs with maximum load 16 ballast at 230 Vac, pushbutton for load direct control - 6 DIN modules

○ F459 **Driver manager**  Integration platform with other brand systems - 6 DIN modules

Contact the BTicino System Integration Service to check the feasibility of specific integrations and to request the licence needed to use the Driver manager (Toll free number 800.837035)

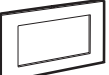
○ 3488W
○ 3488 **HOMETOUCH - Touch screen 7"**  HOMETOUCH - Touch Screen 7" for the management of all MyHOME_Up functions, that can be integrated with the video door entry system and with indoor and outdoor Netatmo cameras, to be used as connected internal unit. To use the home automation functions, configuration is not necessary. It is possible to display the MyHOME_Up system status and control the integrated functions (lights, automation, scenarios, burglar alarm, temperature management, Nuvo music system, ...). Thanks to the "DOOR ENTRY for HOMETOUCH" application, available both for Android and iOS operating systems, it is also possible to manage the video door entry functions of a BTicino 2 wires system using the 7" capacitive display or the Smartphone. Flush mounted installation with box for masonry walls (item 3487) or wall mounted installation with the supplied metal bracket. Available in tech grey and in white.

App DOOR ENTRY for HOMETOUCH  This allows the user to manage the video internal unit calls locally and remotely using the smartphone or with a simple touch open the gate, activate the cameras and the video door entry answering machine.

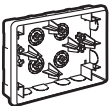
○ 3487 **Box for flush mounted installation**  Box for flush mounted installation of the HOMETOUCH Touch screen item 3488 and 3488W. Width 197 mm, height 148 mm and depth 52 mm.

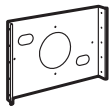
○ 3487AP  Support for flush mounted installation on plasterboard walls of the HOMETOUCH Touch screen item 3488 and 3488W.

App MyHOME_Up  Mobile device App that allows:
- the installer, thanks to a self-learning procedure, to easily associate the devices together when starting up the system;
- the user to manage his home home-automation wherever he is.





KG8013 alexa built-in

Item **Voice control**

- KW8013
- KG8013
- KM8013



Amazon Alexa digital control device with voice assistant, including two touch controls for lighting management.
27 Vd.c. power supply from BUS through connection module item KW8001 or additional power supply unit, item K8003 - 3 modules

K8003

Power supply



Connection module with additional power supply dedicated to Voice control Alexa built-in item KW/KG/KM8013 - 2 modules

- KW8010
- KG8010
- KM8010

Light control



Touch control for the management of ON/OFF light functions. One single control can manage from 1 to 2 functions between single lights, light groups or general lights. - 1 module

- KW8011
- KG8011
- KM8011

Full control



Touch control for the management from 1 to 3 functions between: lights on/off, load control, dimmer, shutters up/down with or without preset, NUVO Player and scenarios. It can also be used as group or general control. It has on-board proximity sensor that allows the display of function icons/symbols when approaching the control - 1 module

- K8002L
- K8002S

ON/OFF actuators for lights and for shutters



Flush-mounted actuator with 2 independent and neutral relays for "zero crossing" function - single or double 230 V~ loads - 1 module



Flush-mounted shutter actuator with 2 independent relays. It allows the management of a specific shutter position. Through the control KW/KG/KM8011, together with the UP/DOWN function monostable and bistable, the actuator also places the shutter in a stored (PRESET) position - 1 module

- K8001

Connection modules



Device for the power supply of controls and actuators through electrified frame item KW/KG/KM8103 KW/KG/KM8103P1 KW/KG/KM8104 KW/KG/KM8104P1 KW/KG/KM8102P1

Item **Blanking module**

- KW8100
- KG8100
- KM8100



Cover for blanking module art. K4950 - 1 module

- KW8102P1
- KG8102P1
- KM8102P1

Electrified frame for 2 module box



Electrified frame with intermediate control separators (removable). For the installation of up to 3 digital controls or covers, item KW/KG/KM8100 in 2-module box with support K8102

- K8102

Support for the 2-module box



Support for the installation of the electrified frame item KW/KG/KM8102P1 in 2 module box.

- KW8103
- KG8103
- KM8103

Electrified frames for 3 and 4 module boxes



Electrified frame with intermediate control separators (removable). For the installation of up to 3 digital controls or covers, item KW/KG/KM8100 in 3-module box with support K4703

- KW8103P1
- KG8103P1
- KM8103P1

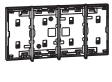

Electrified frame with intermediate control separators (removable). For the installation of up to 4 digital controls or covers, item KW/KG/KM8100 in 3-module box with support K4703

- KW8104
- KG8104
- KM8104

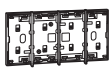

Electrified frame with intermediate control separators (removable). For the installation of up to 4 digital controls or covers, item KW/KG/KM8100 in 4-module box with support K4704

- KW8104P1
- KG8104P1
- KM8104P1

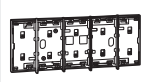

Electrified frame with intermediate control separators (removable). For the installation of up to 5 digital controls or covers, item KW/KG/KM8100 in 4-module box with support K4704



Devices to be completed with appropriate cover as indicated below

Control devices

○ K4652M2 Control for the management of one or two ON/OFF functions, the shutter UP/DOWN function and the adjustment of a dimmer load. It can also be used as scenario control and for the call to the floor, staircase light switching on and door lock activation functions. It manages advanced shutter functions. - 2 modules. To be completed with 1 or 2-module covers.

○ K4652M3 Control for the management of up to three separate functions as described above - 3 modules. To be completed with 1 or 2-module covers.

Actuator/control for lights and generic loads

○ K4672M2L Actuator/control with 2 independent relays for single or double loads: The device can be also configured to manage a remote actuator with the same functions of the K4652M2 and K4652M3 controls - 2 modules. To be completed with 1 or 2-module covers.

Actuator/control for shutter

○ K4672M2S Shutter actuator with 2 internal relay 2 A 250 V~. In addition to the monostable and bistable UP/DOWN function, the actuator also places the rolling shutter in a stored (PRESET) position. The device can be also configured to manage a remote actuator - 2 modules. To be completed with 1 or 2-module covers.

Contact interface

○ 3477 Basic module control interface with 2 independent contacts for the control of 2 actuators for single function loads, or 1 actuator for double function loads (shutters) - the inputs accepts two traditional switches or pushbuttons with NO and NC contact, or a traditional two-way switch, or interlocked pushbuttons.

○ F428 As above - 2 DIN modules

Cover without symbols

1 module

- KW01
- KG01
- KM01

Lightable cover for item K4652M2, K4652M3 and K4672M2L

- KW01X
- KG01X
- KM01X

Lightable cover high brightness for item K4652M2, K4652M3 and K4672M2L

2 modules

- KW01MH2
- KG01MH2
- KM01MH2

Lightable cover for item K4652M2 and K4672M2L

- KW01MH2X
- KG01MH2X
- KM01MH2X

Lightable cover high brightness for item K4652M2 and K4672M2L

LOADS THAT CAN BE DRIVEN (230 V~ 50/60 Hz)

Actuators	Type						
	Energy saving incandescence and halogen lamps	LED lamps	Linear fluorescent lamps ¹⁾	Compact fluorescent lamps	Electronic transformers ³⁾	Ferromagnetic transformers ^{2) 3)}	Reducer motors for shutters ⁴⁾
K4672M2L	1380 W	250 W Max 2 lamps	250 VA	250 W Max 2 lamps	460 W	460 VA	460 W
K4672M2S	-	-	-	-	-	-	2 A 250 Va.c.

- Notes:**
- 1) Power factor corrected fluorescent lamps, discharge lamps.
 - 2) Account must be taken of the transformer yield to calculate the effective power of the load connected to the actuator. For example if a dimmer is connected to a 100 VA ferromagnetic transformer with yield 0.8, the effective power of the load will be 125 VA.
 - 3) The transformer must be loaded at its rated power and however never less than 90% of this power. It is preferable to use a single transformer rather than several transformers in parallel. For example it is better to use a single 250 VA transformer with 5 50W spotlights connected rather than use 5 50 VA transformers in parallel each with a 50 W spotlight.
 - 4) The symbol on the actuators refers to the shutter reducer motors.

White colour cover Black colour cover Sand colour cover ○ Neutral item (without cover)

Items in red colour: New products









KG01MH2AG KM19MH2 KM19MH2A KG01MH2BED KG01MH2GEN KG01MH2BACK KG01MH22D KW01MH2F KW05MH2



Devices to be completed with appropriate cover as indicated below

Item	Cover with symbols	Item	Cover with symbols
1 module Lighttable cover for item K4652M2, K4652M3 and K4672M2L		2 modules Lighttable cover for item K4652M2 and K4672M2L	
<input type="checkbox"/> KW01MHAG <input checked="" type="checkbox"/> KG01MHAG <input type="checkbox"/> KM01MHAG	ON/OFFfunction silk-screen printing	<input type="checkbox"/> KW01MH2AG <input checked="" type="checkbox"/> KG01MH2AG <input type="checkbox"/> KM01MH2AG	ON/OFFfunction silk-screen printing
<input type="checkbox"/> KW19MH <input checked="" type="checkbox"/> KG19MH <input type="checkbox"/> KM19MH	- + and - silk-screen printing for dimmer	<input type="checkbox"/> KW19MH2 <input checked="" type="checkbox"/> KG19MH2 <input type="checkbox"/> KM19MH2	- + and - silk-screen printing for dimmer
<input type="checkbox"/> KW01A <input checked="" type="checkbox"/> KG01A <input type="checkbox"/> KM01A	LIGHT/WAKE UP symbol	<input type="checkbox"/> KW01MH2A <input checked="" type="checkbox"/> KG01MH2A <input type="checkbox"/> KM01MH2A	LIGHT/WAKE UP symbol
<input type="checkbox"/> KW01MHBED <input checked="" type="checkbox"/> KG01MHBED <input type="checkbox"/> KM01MHBED	BED symbol	<input type="checkbox"/> KW01MH2BED <input checked="" type="checkbox"/> KG01MH2BED <input type="checkbox"/> KM01MH2BED	BED symbol
<input type="checkbox"/> KW01MHGEN <input checked="" type="checkbox"/> KG01MHGEN <input type="checkbox"/> KM01MHGEN	GOING OUT symbol	<input type="checkbox"/> KW01MH2GEN <input checked="" type="checkbox"/> KG01MH2GEN <input type="checkbox"/> KM01MH2GEN	GOING OUT symbol
<input type="checkbox"/> KW01MHBACK <input checked="" type="checkbox"/> KG01MHBACK <input type="checkbox"/> KM01MHBACK	COMING IN symbol	<input type="checkbox"/> KW01MH2BACK <input checked="" type="checkbox"/> KG01MH2BACK <input type="checkbox"/> KM01MH2BACK	COMING IN symbol
<input type="checkbox"/> KW01D <input checked="" type="checkbox"/> KG01D <input type="checkbox"/> KM01D	BELL symbol	<input type="checkbox"/> KW01MH2D <input checked="" type="checkbox"/> KG01MH2D <input type="checkbox"/> KM01MH2D	BELL symbol
<input type="checkbox"/> KW01F <input checked="" type="checkbox"/> KG01F <input type="checkbox"/> KM01F	KEY symbol	<input type="checkbox"/> KW01MH2F <input checked="" type="checkbox"/> KG01MH2F <input type="checkbox"/> KM01MH2F	KEY symbol
Lighttable cover for item K4652M2, K4652M3 and K4672M2S		Lighttable cover for item K4652M2 and K4672M2S	
<input type="checkbox"/> KW05 <input checked="" type="checkbox"/> KG05 <input type="checkbox"/> KM05	UP/DOWN silk-screen printing for shutters	<input type="checkbox"/> KW05MH2 <input checked="" type="checkbox"/> KG05MH2 <input type="checkbox"/> KM05MH2	UP/DOWN silk-screen printing
<input type="checkbox"/> KW06MH <input checked="" type="checkbox"/> KG06MH <input type="checkbox"/> KM06MH	STOP symbol silk-screen printing for shutters		



Item	Light control/actuator
○ 3476	 1 relay actuator - for single loads: 2 A resistive or incandescence lamps, 2 A cosφ 0.5 for ferromagnetic transformers - a traditional pushbutton with NO contact accepted in input
○ F411U2	Actuators for centralisations  Actuator with 2 independent relays – for single and double loads: 10 A resistive and 6 A incandescence lamps, 500 W for reducer motors, 2 A cosφ 0.5 for ferromagnetic transformers and 250 W for fluorescent lamps - logic relay interlock via configuration - it has "Zero crossing" technology - 2 DIN modules
○ F411/4	 Actuator with 4 independent relays - for single, double or mixed loads: 2 A resistive, 2 A incandescence lamps, 500 W for reducer motors, 2 A cosφ 0.5 for ferromagnetic transformers and 70 W for fluorescent lamps - logic relay interlock via configuration - 2 DIN modules

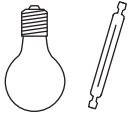
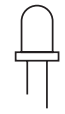
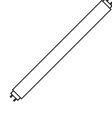

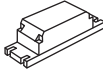
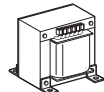
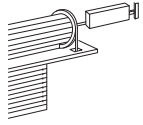
Item	Actuators for centralisations
○ BMSW1003	 ON/OFF actuator, 4 independent outputs with maximum load 16 A at 230 Va.c., clamp connection and RJ45, IP20 protection index, power supply 100/240 Va.c. 50/60 Hz, pushbuttons for load direct control - zero-crossing function - 6 DIN modules
○ BMSW1005	 ON/OFF actuator, "Zero Crossing" technology, 8 independent outputs with maximum load 16 A at 230 V a.c., clamp connection, IP20 protection index, power supply 100/240 V a.c. 50/60 Hz, pushbuttons for load direct control - 10 DIN modules
○ F401	 Actuator with 2 internal relays and 4 pushbuttons. In addition to monostable and bistable UP/DOWN operation, the actuator also places the shutter in a stored (PRESET) position - 2 DIN modules



LOADS THAT CAN BE DRIVEN (250 V~ 50/60 Hz)							
Actuators	Type						
							
	Energy saving incandescence and halogen lamps	LED lamps	Linear fluorescent lamps ¹⁾	Compact fluorescent lamps	Electronic transformers ³⁾	Ferromagnetic transformers ^{2) 3)}	Reducer motors for shutters ⁴⁾
3476	2 A 460 W	40 W Max 1 lamp	- -	40 W Max 1 lamp	- -	2 A cosφ 0,5 460 VA	- -
F411U2	10 A 1380 W	250 W Max 4 lamps	4 A 230 W	250 W Max 4 lamps	4 A 230 W	4 A cosφ 0,5 460 VA	2 A 460 W
F411/4	2 A 460 W	70 W Max 2 lamps	0.3 A 70 W	70 W Max 2 lamps	0.3 A 70 W	2 A cosφ 0,5 460 VA	2 A 460 W
BMSW1003	16 A 3680 W	2.1 A 500 VA	10 X (2 X 36 W) 4.3 A	1150 W 5 A	16 A 3680 W	16 A 3680 W	- -
BMSW1005	16 A 3680 W	2.1 A 500 VA	4.3 A 10X2X36 W	5 A 1150 VA	16 A 3680 W	16 A 3680 W	- -
F401							2 A 250 Va.c.





- Notes:**
- 1) Power factor corrected fluorescent lamps, discharge lamps.
 - 2) Account must be taken of the transformer yield to calculate the effective power of the load connected to the actuator. For example if a dimmer is connected to a 100 VA ferromagnetic transformer with yield 0.8, the effective power of the load will be 125 VA.
 - 3) The transformer must be loaded at its rated power and however never less than 90% of this power. It is preferable to use a single transformer rather than several transformers in parallel. For example it is better to use a single 250 VA transformer with 5 50W spotlights connected rather than use 5 50 VA transformers in parallel each with a 50 W spotlight.
 - 4) The  symbol on the actuators refers to the shutter reducer motors.

Living Now MyHOME_Up
 dimmer actuators for lights, shutters and different loads
 eliot™

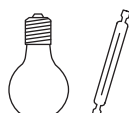

Item	Dimmers for centralisations
○ F413N	 1-output dimmer to supply fluorescent lamps or LED sources with input 1-10 V for single loads up to 2.5 A at 230 Va.c. – type of screw connection - power supply 27 Vd.c. – absorption 30 mA – max 10 ballast that can be connected (clamps 1-2) - with pushbutton for load direct control - version for fastening on DIN rail - 2 modules
○ BMDI1002	 1/10V dimmer, “Zero Crossing” technology, 4 outputs with maximum load 4.3 A at 230 V a.c., clamp connection, IP20 protection index, power supply 100/240 V a.c. 50/60 Hz, pushbuttons for load direct control - 10 DIN modules
○ F429	 DALI dimmer with 8 independent outputs for the connection of up to 16 DALI reactors for each output – 230 V a.c. power supply 50/60 Hz; 110 - 240 Vd.c. – absorption 5 mA – with pushbutton for load direct control - version for fastening on DIN rail - 6 modules

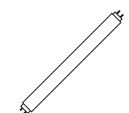
Item	Multi-load dimmers for centralisations
○ F416U1	 Multi-load dimmer, 1 output with maximum load 4.3 A at 230 Va.c., clamp connection and RJ45, IP20 protection index, power supply 100/240 Va.c. 50/60 Hz, pushbutton for load direct control - 6 DIN modules
○ F418U2	 Two-channel dimmer for the management of dimmer LEDs, dimmer compact fluorescent lamps (CFL), energy saving halogen lamps and electronic transformers at 110-230V. Possibility of parallelisation of the two channels to increase the maximum power which can be managed, power supply 27 Vd.c., absorption 18 mA - version for fastening on DIN rail - 4 modules

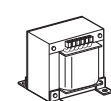
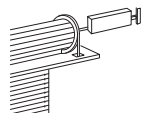
LOADS THAT CAN BE DRIVEN (230 V~ 50/60 HZ)							
Actuators	Type						
							
	Energy saving incandescence and halogen lamps	LED lamps	Linear fluorescent lamps ¹⁾	Compact fluorescent lamps	Electronic transformers ³⁾	Ferromagnetic transformers ^{2) 3)}	Reducer motors for shutters ⁴⁾
BMDI1002	Dimmer for ballast - 4 x 4.3 A outputs - 4x 1000VA@ 230 Vac - 4x500VA@ 230 Vac						
F413N	-	-	2 A 460 W ⁵⁾ Max 10 ballast, type T5, T8, compact or driver for LED	-	-	-	-
F414	0.25 - 4.3 A 60 - 1000 VA	-	-	-	-	0.25 - 4.3 A 60 - 1000 VA	-
F416U1	4.3 A 40 - 1000 W	-	-	-	4.3 A 40 - 1000 W	4.3 A 40 - 1000 W	-
F418U2	2x300 W	2x300 VA	-	2x300 VA	2x300 VA	2x300 VA	-
F429	SCS/DALI dimmer interface - 8 x16 ballast						

- Notes:**
- 1) Power factor corrected fluorescent lamps, discharge lamps. 2) Account must be taken of the transformer yield to calculate the effective power of the load connected to the actuator. For example if a dimmer is connected to a 100 VA ferromagnetic transformer with yield 0.8, the effective power of the load will be 125 VA.
 - 3) The transformer must be loaded at its rated power and however never less than 90% of this power. It is preferable to use a single transformer rather than several transformers in parallel. For example it is better to use a single 250 VA transformer with 5 50W spotlights connected rather than use 5 50 VA transformers in parallel each with a 50 W spotlight.
 - 4) The  symbol on the actuators refers to the shutter reducer motors.
 - 5) Only compatible with lamps with 1/10 V ballast.

White colour cover
 Black colour cover
 Sand colour cover
 ○ Neutral item (without cover)
 Items in red colour: New products



Devices to be completed with appropriate cover as indicated below

Lighting/movement sensors

BMSE3001 passive infrared SCS sensor for the detection of movement and the lighting level. Ceiling flush mounted installation using springs or installation boxes; surface installation using surface installation box, item 048875; IP20 protection index; RJ45 clamp connection; 8 m (50 m²) diameter coverage area for a 2.5 m installation height, maximum installation height 6 m; 27 V d.c. power supply from bus, absorption 12 mA; regulation with basic/advanced remote control (BMSO4003 and BMSO4001) or through configuration software, of the lighting level, from 5 to 1275 LUX, of the time delay, from 30 s to 255 h, and of the main operating parameters; Push&Learn pushbutton

BMSE3003 Double technology SCS sensor: passive infrared for the detection of presence and the lighting level. Ceiling flush mounted installation using springs or installation boxes; surface installation using surface installation box, item 048875; IP20 protection index; RJ45 clamp connection; 8 m diameter (50 m²) infrared coverage area for a 2.5 m installation height, 11 mm diameter (95 m²) ultrasound coverage area for a 2.5 m installation height, maximum installation height 6 m; 27 V d.c. power supply from BUS, absorption 17 mA; regulation with basic/advanced remote control (BMSO4003 and BMSO4001), or through configuration software, of the lighting level, from 5 to 1275 LUX, of the delay, from 30 s to 255 h, and of the main operating parameters; Push&Learn pushbutton

048834 IP55 passive IR (PIR) movement sensor, suitable for the detection of movement in outdoor or indoor transit areas (corridors, cellars, garage paths). Coverage area: 140° x 15m at 2.5m high. Operating mode (automatic or manual), time delay (5 s to 59min), and brightness threshold (20 to 1275 LUX) settable using the advanced/basic (BMSO4001/BMSO4003) configuration remote control; physical or virtual configuration. Wall or angular installation by means of accessory item 048971

PIR passive infrared sensors

K4659 Green Switch: passive IR (PIR) sensor, suitable for the detection of presence in transit areas (corridors, toilets, service rooms). Operating mode (automatic or manual), time delay (5 s to 59min), and brightness threshold (20 to 1275 LUX) settable using the advanced/basic (BMSO4001/BMSO4003) configuration remote control; physical or virtual configuration. - 2 modules

Cover for K4659

KW17 White
 KG17 Black
 KM17 Sand

Configuration remote controls

BMSO4001 The advanced configuration remote control, with IR transmitter and receiver, adjusts the main operating parameters of: Switch Sensor, Green Switch and SCS compatible sensors. With display for the acquisition of the parameters set on the sensors and to modify them. Batteries charged by USB mini port.

BMSO4003 The basic configuration remote control, with IR transmitter, adjusts the main operating parameters of: Switch Sensor, Green Switch and SCS compatible sensors. Modification of parameters only possible for preset values, battery recharge not available

Installation accessories

048875 Ceiling mounted box compatible with the sensors: BMSE3001 and BMSE3003, IP20 protection index, dimensions Ø 100 x 50 mm

048971 Angle installation accessory, compatible with the 048834 accessory, IP42 protection index, dimensions (hxlxd) 115 x 75 x 40 mm

FEATURES OF THE LIGHTING/MOVMEMENT SENSORS

SCS sensors	048834	BMSE3001	BMSE3003
Installation	wall mounted	ceiling flush mounted	
Type of operation	AUTO/ECO/WALKTHROUGH	AUTO/ECO/WALKTHROUGH	
Sensor technology	PIR	PIR	PIR+US
Power supply	27 V d.c. from Bus	27 V d.c. from Bus	
Protection index	IP55	IP20	
Coverage area at 2.5 m	15 m x 6 m	Ø 8 m	Ø 11 m
Coverage angles (v/h)	45°/140°	90/360°	
Lighting level	5 lux - 1275 lux	5 lux - 1275 lux	
Switching off delay	5 s - 59 min - 59 h	30 s - 255 h - 59 min - 59 sec	
Factory adjustments	300 lux - 15 min	300 lux - 15 min	
Connection type	SCS clamp	RJ45 connector	







White colour cover Black colour cover Sand colour cover Neutral item (without cover)

Items in red colour: New products



Devices to be completed with appropriate cover as indicated below

Item	Thermostat
<input type="checkbox"/> KW4691 <input checked="" type="checkbox"/> KG4691 <input type="checkbox"/> KM4691	Probe with backlit display that controls the temperature of an individual zone. It features an input for the connection of a contact line (e.g. window contact). It can be used for the management of different types of systems, and the adjustment of the fan speed when fan coils are used. Possibility of automatic operation (summer/winter), with compatible systems - 2 modules White Black Sand

Item	Probe without display
○ 3454	 Temperature probe in basic module with wired sensor - to be associated to the temperature sensor item 3457 and Vantage probe item 8051
○ 3457	 Accessories Temperature probe to be associated to the probe item 3454
○ F430/2	 Actuators Actuator with 2 independent relays – for single and double loads: 6 A resistive, 2A motor driven valves and pumps - configuration based logic relay interlock - 2 DIN modules
○ F430/4	 Actuator with 4 independent relays - for single, double or mixed loads: 4 A resistive, 1 A motor driven valves, pumps and fan coils - configuration based logic relay interlock - 2 DIN modules
○ F430R8	 Actuator with 8 independent relays for the control of on-off valves, motorised valves (open-close and three points), pumps and fan coils with 2 and 4 tubes - 4A resistive, 1A motor valves, pumps and fan-coils- SCS-bus connection - 4 DIN modules
○ F430R3V10	 Actuator with 3 independent relays and 2 x 0-10 Volts outputs for the control of fan coils with 2 and 4 tubes with proportional 0-10 Volt valves - 4A resistive, 1A fan coil - SCS-BUS connection - 4 DIN modules
○ F430V10	 Actuator with 2 x 0-10 Volt outputs for the control of 0-10 proportional valves - SCS-BUS connection - 2 DIN modules

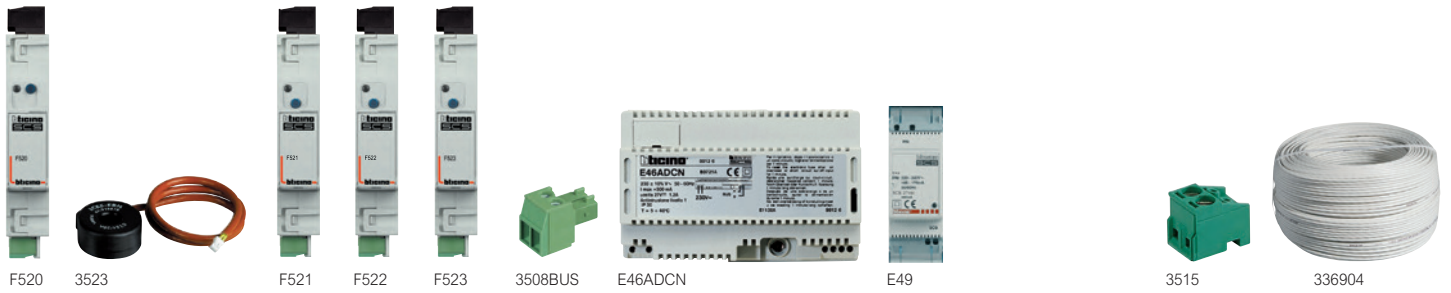

Item	Consumption display
○ F520	Meter for the measurement of electricity on a maximum of 3 lines, by connecting 3 toroids to the appropriate inputs. Version for fastening on DIN rail - 1 module. The device is fitted with 1 toroid.
○ 3523	Additional electricity meter toroid, item F520 and for actuator with sensor, item F522 for the measurement of the earth leakage current. Cable length 400 mm.

Item	Load control management
○ F521	Central unit for the management and control of the actuators of the load control system, to prevent the risk of detachment of the limiter of the electricity supplier. The central unit manages up to 63 loads, a contract power between 1.5 and 18 kW, and tolerance up to +/- 20%. It integrates an electricity meter for the controlled line. Version for fastening on DIN rail - 1 module. The device is fitted with 1 toroid.
○ F522	Actuator with integrated current sensor for the measurement of the controlled load consumptions. 1 relay - 10 A for incandescence lamps and 4 A for fluorescent lamps or ferromagnetic transformers, and 500 for compact fluorescent and LED lamps - Bistable relay with zero crossing for the Automation and/or Load control management functions. Version for fastening on DIN rail - 1 module. Earth leakage control by connecting the additional toroid, item 3523.
○ F523	1 relay actuator - for incandescence lamps and 4 A for fluorescent lamps or ferromagnetic transformers, and 500 W for compact fluorescent and LED lamps - bistable relay with zero crossing for the Automation and/or Load control management functions. Version for fastening on DIN rail - 1 module.

Item	Accessories
○ 3508BUS	removable clamp for BUS connection - width 3.81 mm
○ 3508U2	removable clamp 2 poles
○ 3508U3	removable clamp 3 poles

Item	Power supplies
○ E46ADCN	Power supply - input 230 Va.c. output 27 Vd.c. SELV - maximum absorbed current 450mA - installation on DIN profile for flush mounted or wall-mounted switchboards - 8 DIN modules
○ E49	Compact power supply - input 230 Va.c. - output 27 Vd.c. Maximum current delivered 600 mA - 2 DIN modules.

Item	Various accessories
○ 3515	spare removable clamp

Item	Connection cables
○ L4669	Sheathed pair made up of 2 flexible wires with unshielded plaited sheath - insulation 300/500 V - complies with standards CEI 46-5 and CEI 20-20 - coil length 100 metres
○ L4669/500	as above - in 500 m coils
○ L4669KM1	As above - reel length 1000 m (1)
○ 336905	As above - low toxicity cable without halogens - ideal for application in environments where fire hazard safety is critical - coil length 200 metres
○ 336904	Specific cable with 2 twisted conductors. It can be installed in underground piping, in accordance with standards (CEI 20-13 and CEI 20-14). It ensures the best performance in video systems (higher distance between EP and Handset when compared with other cables). 200 m coil

System	Cable	
	L4669 - L4669/500	336904
	L4669KM1 - 336905	
Automation	●	●(1)
Energy Management/Consumption Display	●	●(1)
Temperature control	●	●(1)
Video door entry system		●











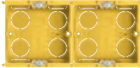
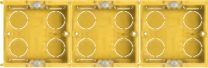
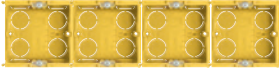



NOTE (1): for systems underground cable sections

Living Now

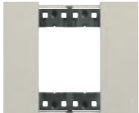
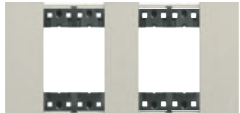
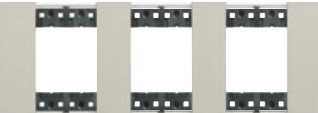
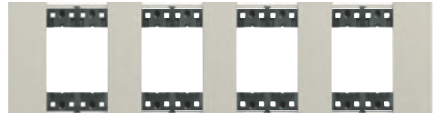
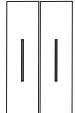
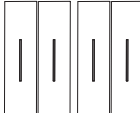
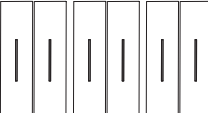

INSTALLATION AND COVER PLATE RANGE

SELECTION TABLE

	2 modules	2+2 modules	2+2+2 modules	2+2+2+2 modules
Flush mounted boxes	 502E (70x70x50 mm)	 502E (70x70x50 mm)	 502E (70x70x50 mm)	 502E (70x70x50 mm)
Plasterboard boxes	 PB502N (Ø 71x50.5 mm)	 PB502N (Ø 71x50.5 mm)	 PB502N (Ø 71x50.5 mm)	 PB502N (Ø 71x50.5 mm)
Supports	 K4702 (*)	 K4702 (*)	 K4702 (*)	 K4702 (*)
No. of function modules	 2 modules	 2+2 modules	 2+2+2 modules	 2+2+2+2 modules
Living Now cover plates	 KA4802...(**)	 KA4802M2...(**)	 KA4802M3...(**)	 KA4802M4...(**)
No. of 1-module covers required for the completion of the light point	 2 covers	 2+2 covers	 2+2+2 covers	 2+2+2+2 covers

Note: (*) supplied without screws. Fastening using the screws supplied with boxes 502E and PB502N.
(**) both horizontal and vertical installation



- Note: protective shell supplied with supports, available in all modularities.

To be used:

- at the site, before the installation of cover plates and covers
- after removing cover plates and covers when painting the walls

Living Now
installation examples

EXAMPLE OF INSTALLATION OF THE LIGHT POINT WITH 1-MODULE COVER

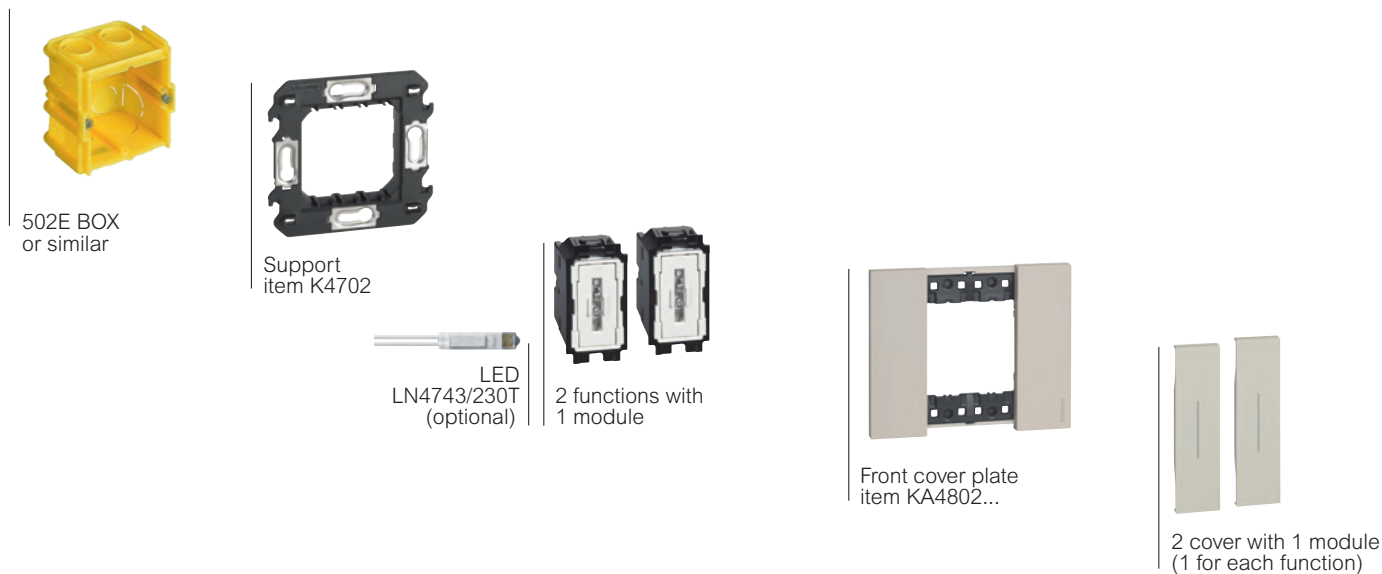

EXAMPLE OF LIGHT POINT COMPOSITION

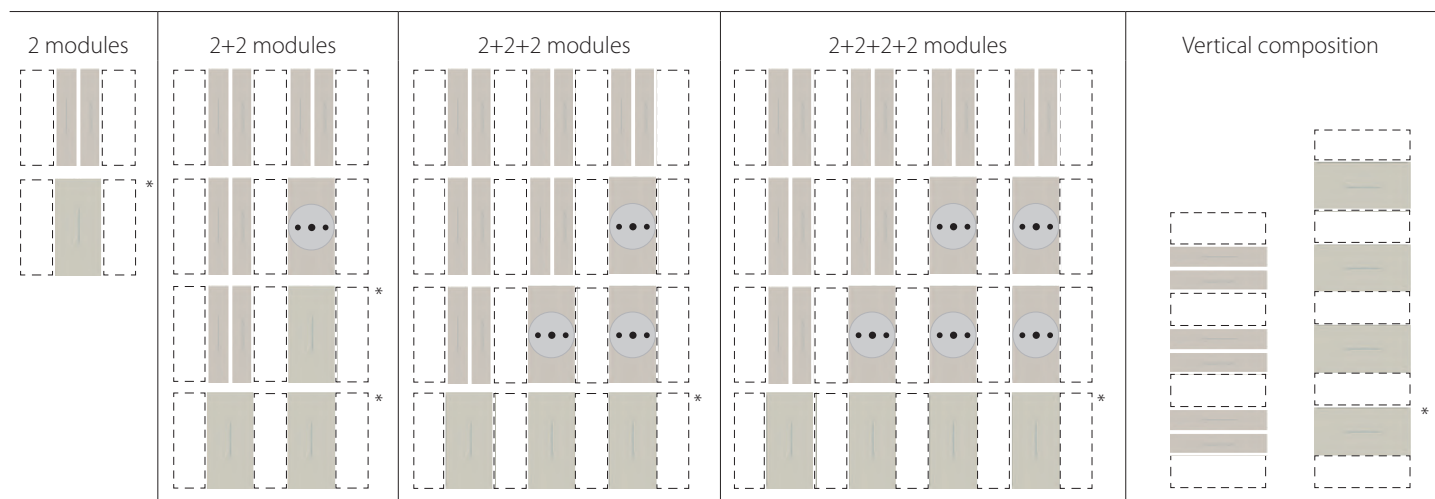

* **Note:** for solutions using one 2-module cover for the main controls, it will be necessary to use two "half-module blanking modules" (item K4949) at the sides of the control. (see the sample diagrams below)

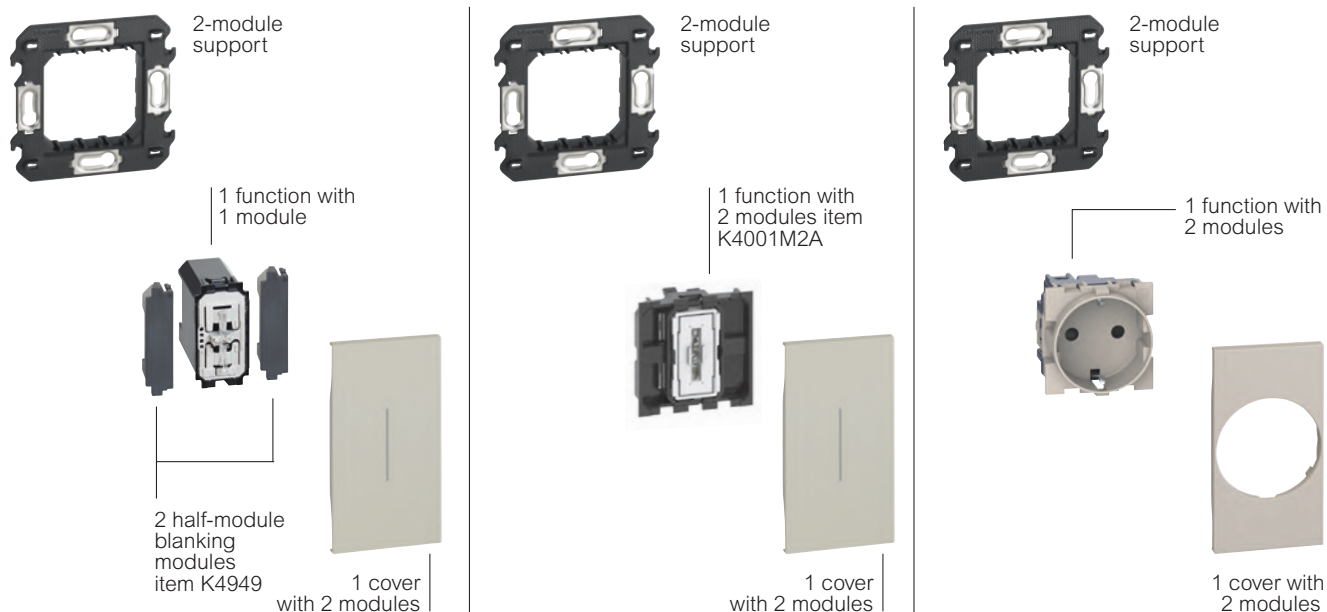

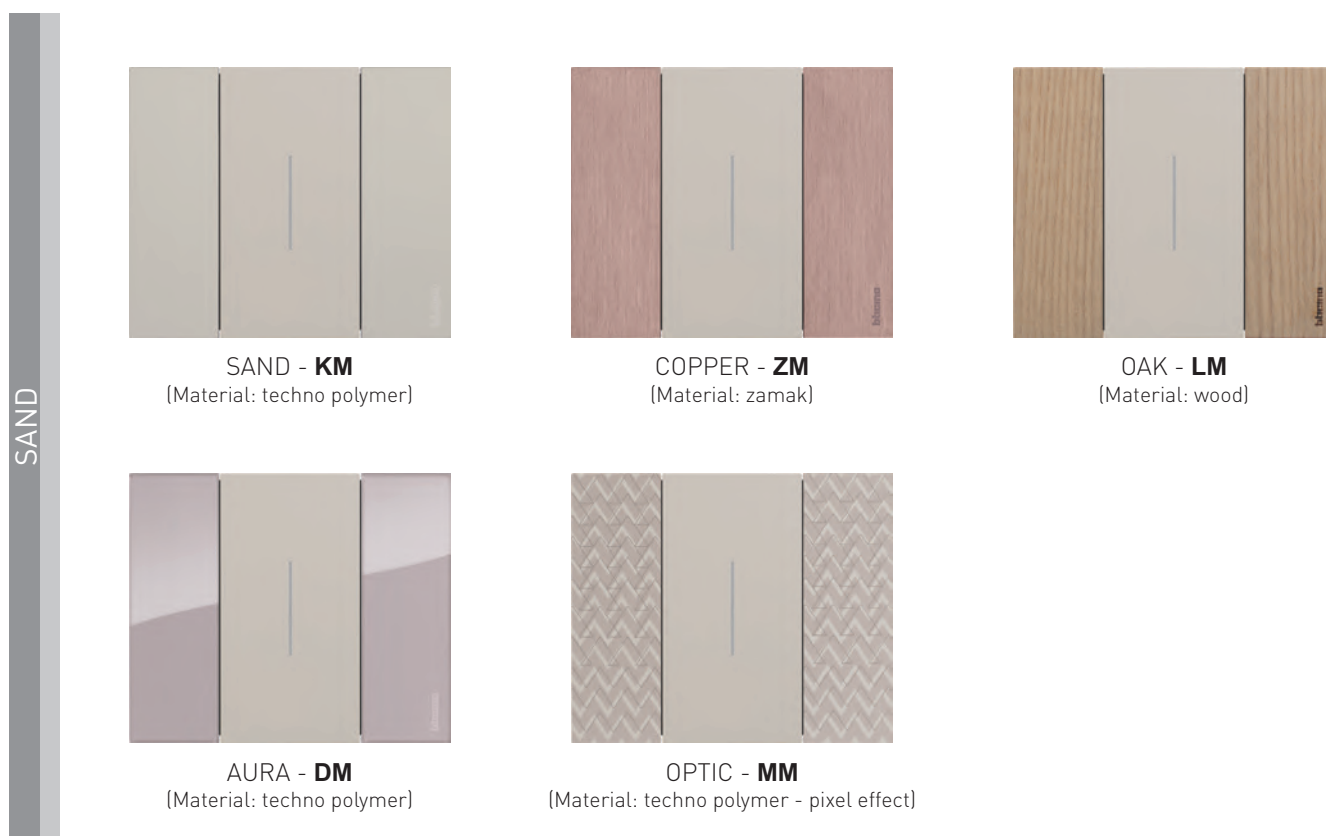





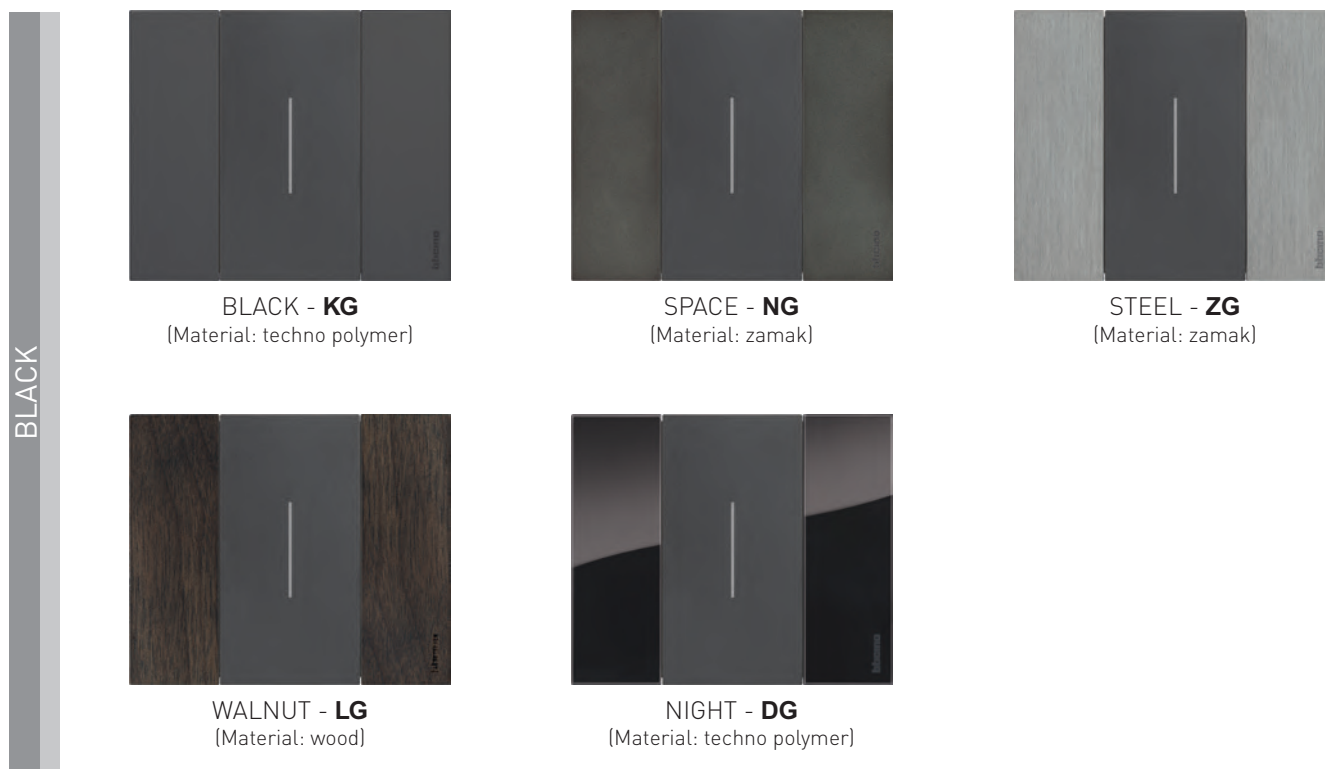



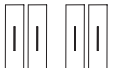













Notes:

- The cover plate/cover combinations shown in these pages are purely indicative. Each cover plate can in fact be combined with covers of any colours, as required by the customer (white, sand and black).
- The zamak and wood finishes are obtained using non-mass production procedures. The differences among the various cover plates are therefore a distinguishing valuable element.





















SELECTION TABLE

Finish	 2 modules		 2+2 modules		 2+2+2 modules		 2+2+2+2 modules	
	 WHITE	KA4802KW	KA4802M2KW	KA4802M3KW	KA4802M4KW			
 GOLD	KA4802ZW	KA4802M2ZW	KA4802M3ZW	KA4802M4ZW				
 MOON	KA4802NW	KA4802M2NW	KA4802M3NW	KA4802M4NW				
 ICE	KA4802DW	KA4802M2DW	KA4802M3DW	KA4802M4DW				
 SKY	KA4802DA	KA4802M2DA	KA4802M3DA	KA4802M4DA				
 PIXEL	KA4802MW	KA4802M2MW	KA4802M3MW	KA4802M4MW				
 SAND	KA4802KM	KA4802M2KM	KA4802M3KM	KA4802M4KM				
 COPPER	KA4802ZM	KA4802M2ZM	KA4802M3ZM	KA4802M4ZM				
 OAK	KA4802LM	KA4802M2LM	KA4802M3LM	KA4802M4LM				
 AURA	KA4802DM	KA4802M2DM	KA4802M3DM	KA4802M4DM				
 OPTIC	KA4802MM	KA4802M2MM	KA4802M3MM	KA4802M4MM				
 BLACK	KA4802KG	KA4802M2KG	KA4802M3KG	KA4802M4KG				
 SPACE	KA4802NG	KA4802M2NG	KA4802M3NG	KA4802M4NG				
 STEEL	KA4802ZG	KA4802M2ZG	KA4802M3ZG	KA4802M4ZG				
 WALNUT	KA4802LG	KA4802M2LG	KA4802M3LG	KA4802M4LG				
 NIGHT	KA4802DG	KA4802M2DG	KA4802M3DG	KA4802M4DG				
Supports	 K4702	 K4702 [x 2]	 K4702 [x 3]	 K4702 [x 4]				

Items in red colour: New products

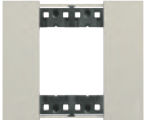
SELECTION TABLE

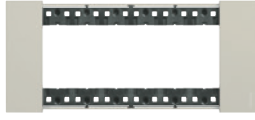
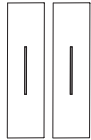
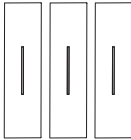
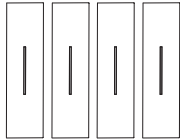
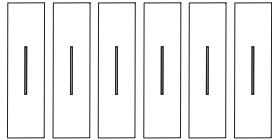
	2 modules	3 modules	4 modules	6 modules
Flush mounted boxes	 502E (70x70x50 mm)	 503E (108x74x53.5 mm)	 504E (133x74x53.5 mm)	 506L (183.5x90x53.5 mm)
Plasterboard boxes	 PB502N (Ø 71x50.5 mm)	 PB503N (110x71x52 mm)	 PB504N (132.5x71x52 mm)	 PB506N (183x71x52 mm)
Supports	 K4702 (*)	 K4703 with screws	 K4704 with screw	 K4706 with screw
No. of function modules	 2 modules	 3 modules	 4 modules	 6 modules
Living Now cover plates	 KA4802...	 KA4803...	 KA4804...	 KA4806...
No. of 1-module covers required for the completion of the light point	 2 covers	 3 covers	 4 covers	 6 covers

* Note: supplied without screws. Fastening using the screws supplied with boxes 502E and PB502N.

PROTECTED INSTALLATIONS

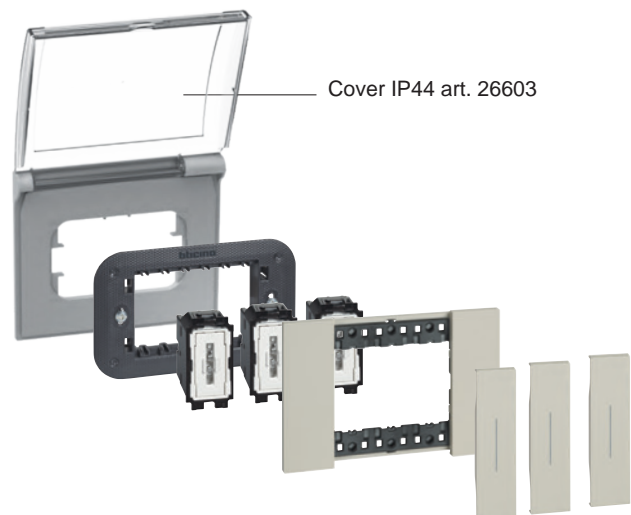

Cover IP44 art. 26603



- Note: protective shell supplied with supports, available in all modularities.

To be used:

- at the site, before the installation of cover plates and covers
- after removing cover plates and covers when painting the walls

Living Now
installation examples

EXAMPLE OF INSTALLATION OF THE LIGHT POINT WITH 1-MODULE COVER

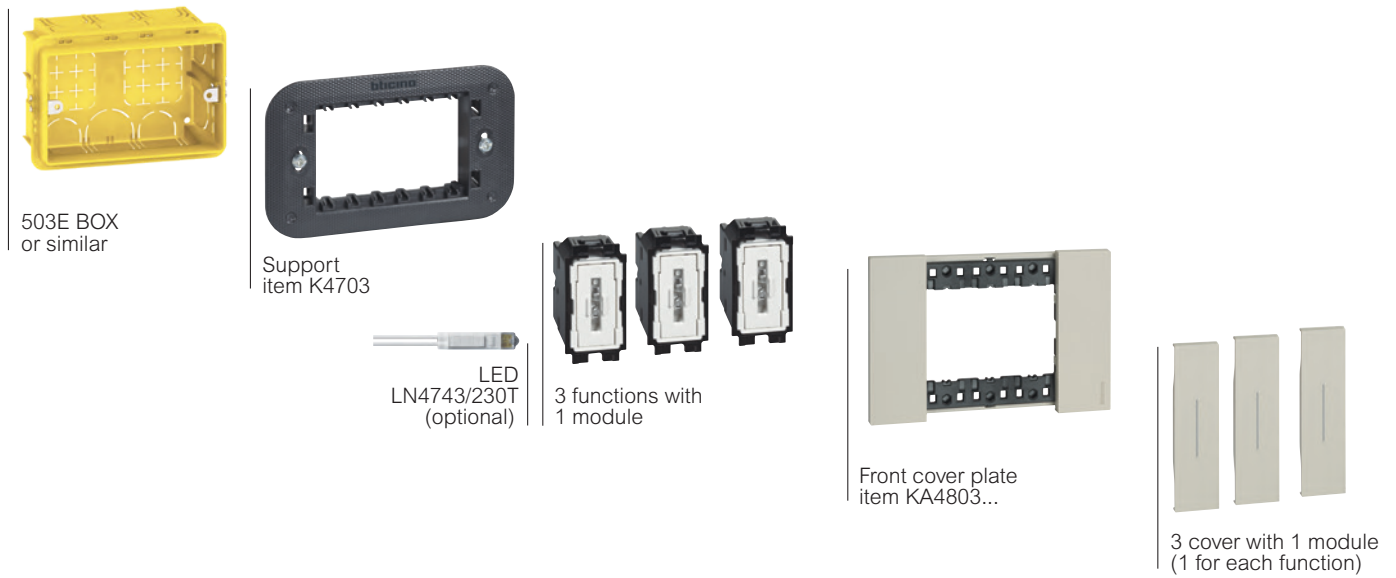

EXAMPLE OF LIGHT POINT COMPOSITION

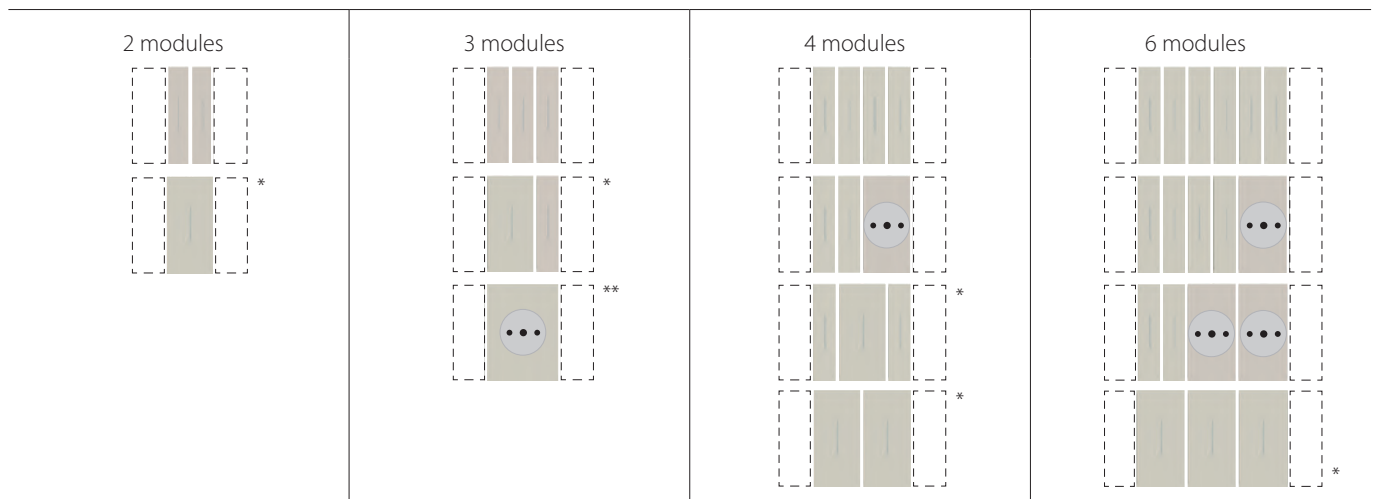

* **Note:** for solutions using one 2-module cover for the main controls, it will be necessary to use two "half-module blanking modules" (item K4949) at the sides of the control. (see the sample diagrams below)

** German standard socket centred on 3-module light point

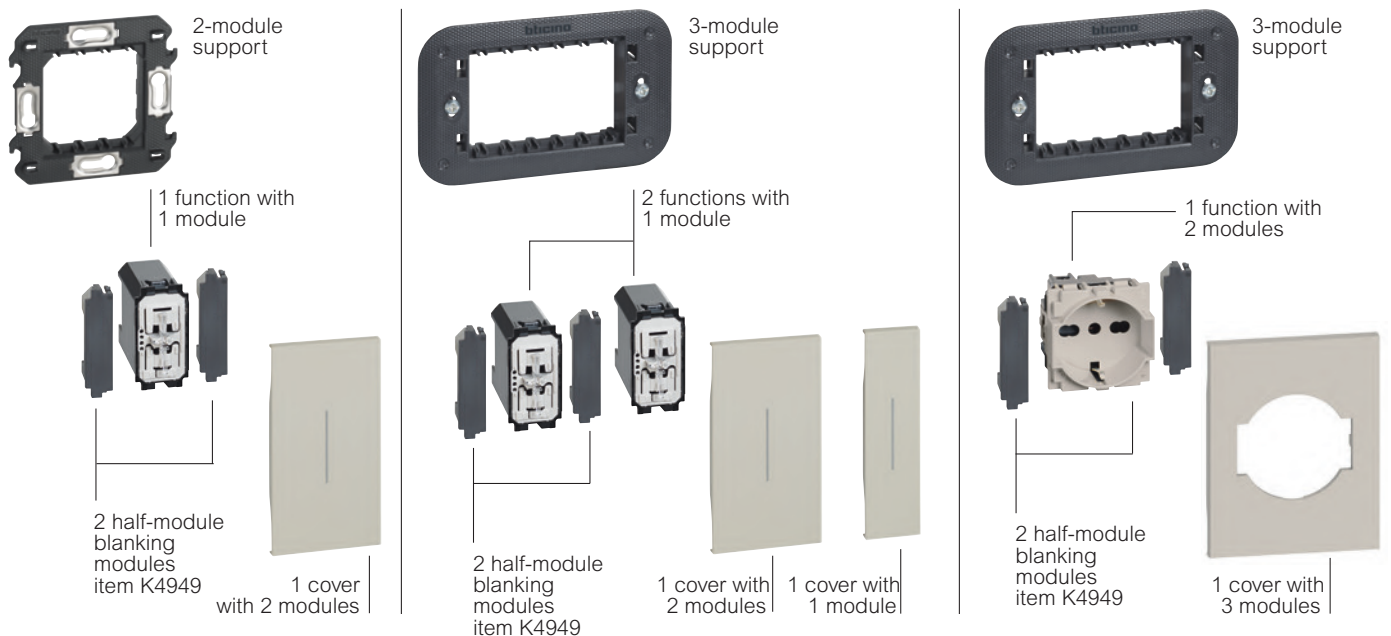

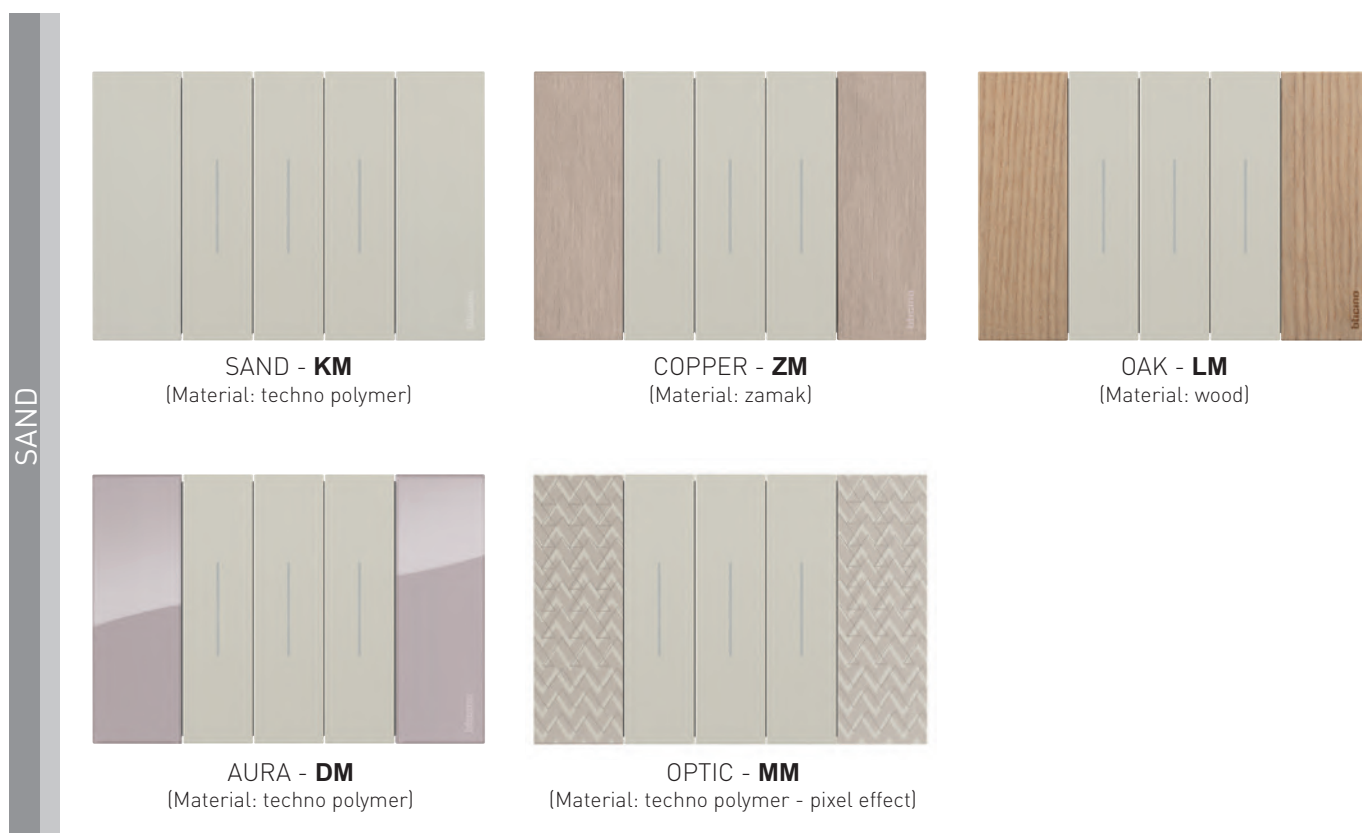
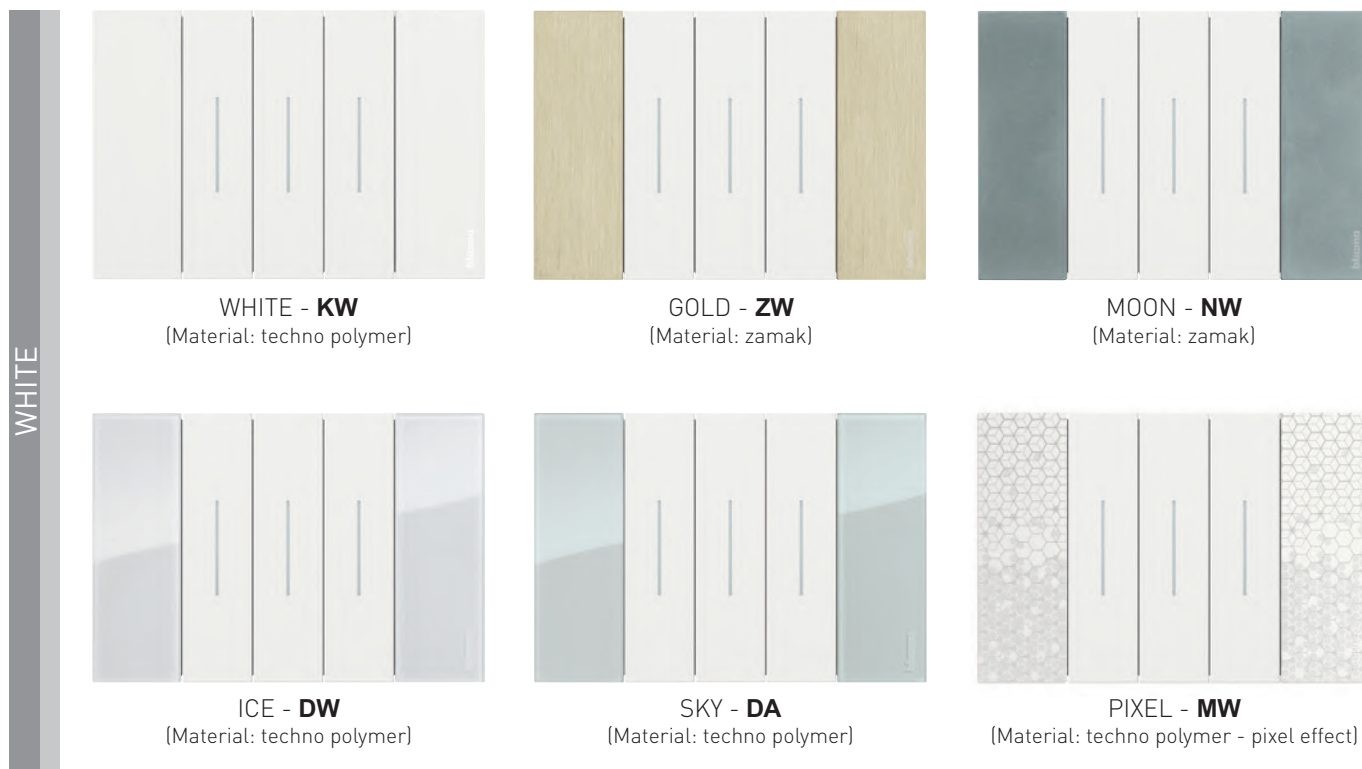





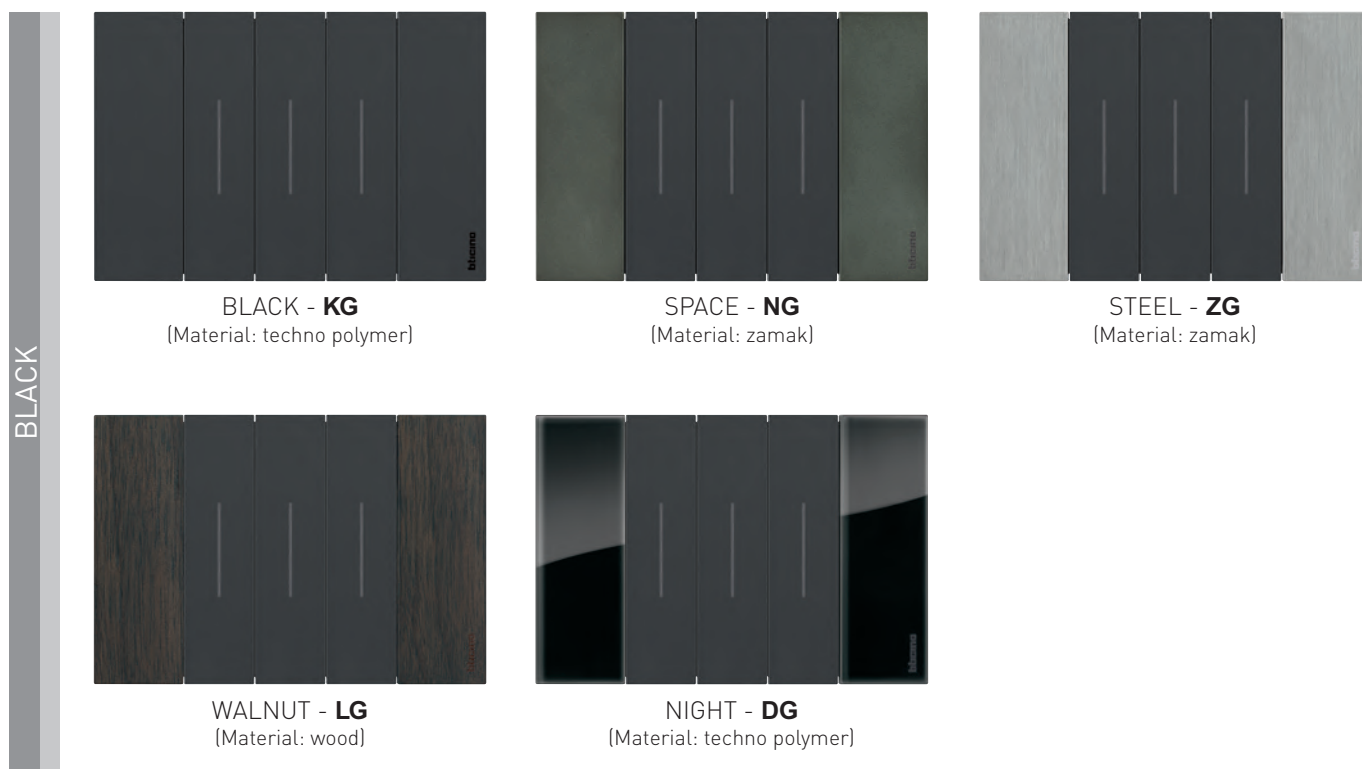





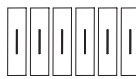











Notes:

- The cover plate/cover combinations shown in these pages are purely indicative. Each cover plate can in fact be combined with covers of any colours, as required by the customer (white, sand and black).
- The zamak and wood finishes are obtained using non-mass production procedures. The differences among the various cover plates are therefore a distinguishing valuable element.

























SELECTION TABLE

Finish	 2 modules		 3 modules		 4 modules		 6 modules	
	 WHITE	KA4802KW	KA4803KW	KA4804KW	KA4806KW			
 GOLD	KA4802ZW	KA4803ZW	KA4804ZW	KA4806ZW				
 MOON	KA4802NW	KA4803NW	KA4804NW	KA4806NW				
 ICE	KA4802DW	KA4803DW	KA4804DW	KA4806DW				
 SKY	KA4802DA	KA4803DA	KA4804DA	KA4806DA				
 PIXEL	KA4802MW	KA4803MW	KA4804MW	KA4806MW				
 SAND	KA4802KM	KA4803KM	KA4804KM	KA4806KM				
 COPPER	KA4802ZM	KA4803ZM	KA4804ZM	KA4806ZM				
 OAK	KA4802LM	KA4803LM	KA4804LM	KA4806LM				
 AURA	KA4802DM	KA4803DM	KA4804DM	KA4806DM				
 OPTIC	KA4802MM	KA4803MM	KA4804MM	KA4806MM				
 BLACK	KA4802KG	KA4803KG	KA4804KG	KA4806KG				
 SPACE	KA4802NG	KA4803NG	KA4804NG	KA4806NG				
 STEEL	KA4802ZG	KA4803ZG	KA4804ZG	KA4806ZG				
 WALNUT	KA4802LG	KA4803LG	KA4804LG	KA4806LG				
 NIGHT	KA4802DG	KA4803DG	KA4804DG	KA4806DG				
Supports	 K4702	 K4703	 K4704	 K4706				

Items in red colour: New products

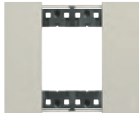
SELECTION TABLE

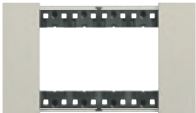
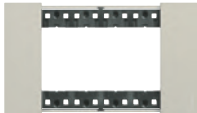
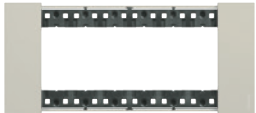
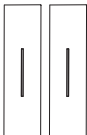
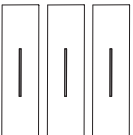
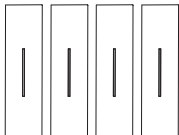
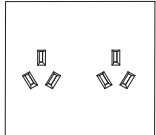
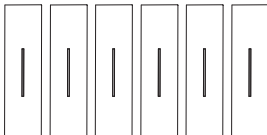
	2 modules	3 modules	4 modules	4 modules socket K4134 (to be used with 3 module boxes only)	6 modules
Flush mounted boxes	 502E (70x70x50 mm)	 503E (108x74x53.5 mm)	 504E (133x74x53.5 mm)	 503E (108x74x53.5 mm)	 506L (183.5x90x53.5 mm)
Plasterboard boxes	 PB502N (Ø 71x50.5 mm)	 PB503N (110x71x52 mm)	 PB504N (132.5x71x52 mm)	 PB503N (110x71x52 mm)	 PB506N (183x71x52 mm)
Supports (screw fixing only)	 K4702 (*)	 K4703AU with screws	 K4704 with screw	 Provided with socket	 K4706 with screw
No. of function modules	 2 modules	 3 modules	 4 modules	 4 modules	 6 modules
Living Now cover plates	 KA4802...	 KA4803...	 KA4804...	 KA4814...	 KA4806...
No. of 1-module covers required to complete the switches	 2 covers	 3 covers	 4 covers	 specific covers	 6 covers

* Note: supplied without screws. Fastening using the screws supplied with boxes 502E and PB502N.

Living Now
installation examples

EXAMPLE OF INSTALLATION OF THE LIGHT POINT WITH 1-MODULE COVER

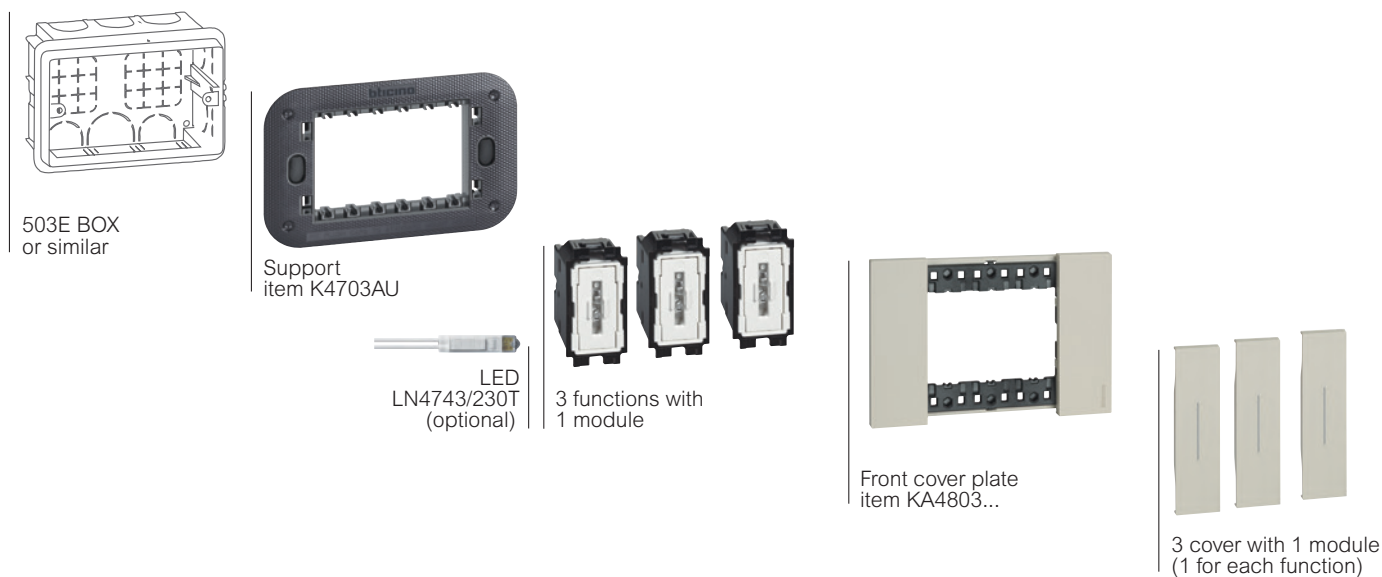

EXAMPLE OF LIGHT POINT COMPOSITION

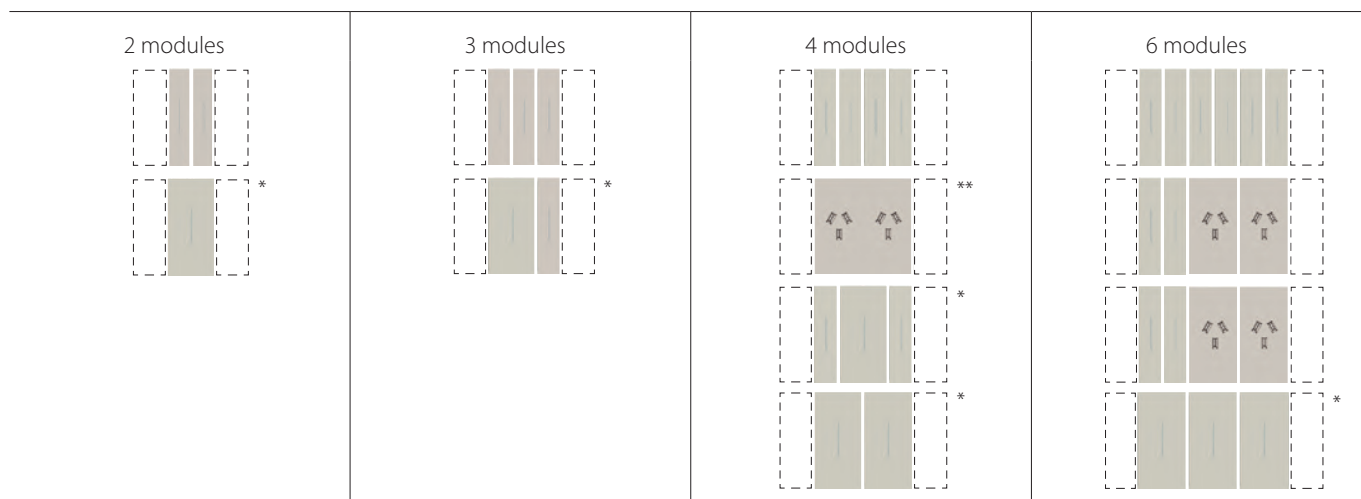

* **Note:** for solutions using one 2-module cover for the main controls, it will be necessary to use two "half-module blanking modules" (item K4949) at the sides of the control. (see the sample diagrams below)

** monoblock installed on a three module box

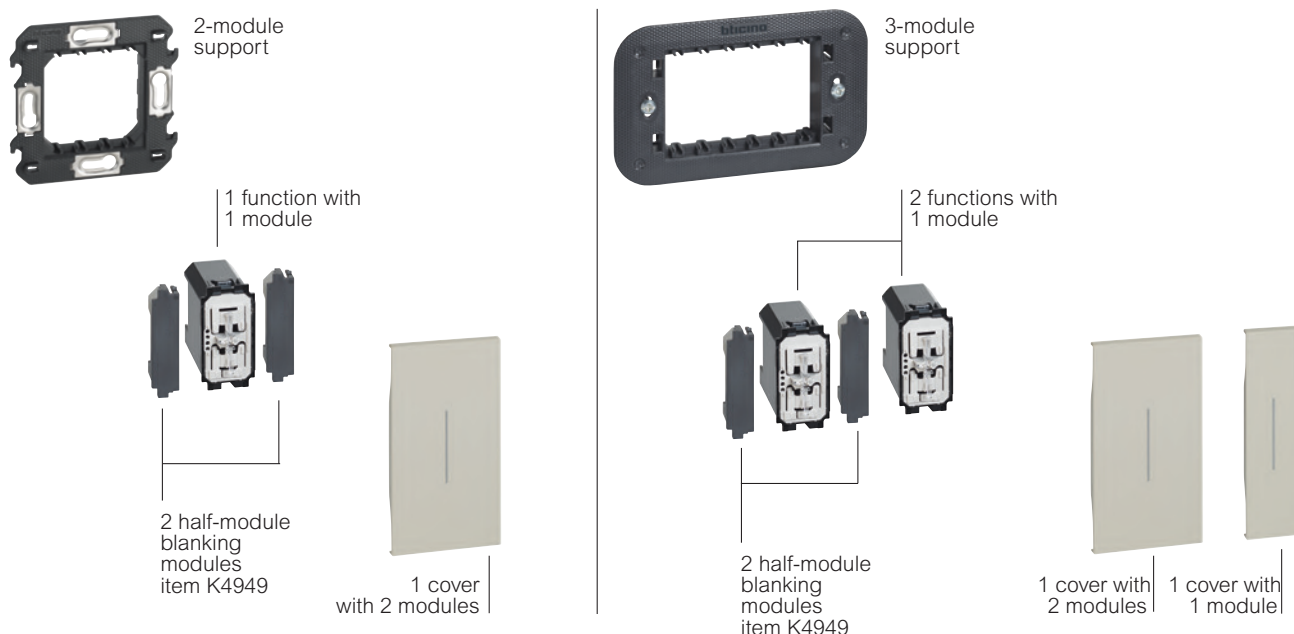

WHITE



WHITE - KW
(Material: techno polymer)



GOLD - ZW
(Material: zamak)



MOON - NW
(Material: zamak)



ICE - DW
(Material: techno polymer)



SKY - DA
(Material: techno polymer)



PIXEL - MW
(Material: techno polymer - pixel effect)

BLACK



BLACK - KG
(Material: techno polymer)



SPACE - NG
(Material: zamak)



STEEL - ZG
(Material: zamak)



WALNUT - LG
(Material: wood)





















NIGHT - DG
(Material: techno polymer)

Notes:























- The cover plate/cover combinations shown in these pages are purely indicative. Each cover plate can in fact be combined with covers of any colours, as required by the customer (white, sand and black).
- The zamak and wood finishes are obtained using non-mass production procedures. The differences among the various cover plates are therefore a distinguishing valuable element.

SELECTION TABLE

						
Finish		2 modules	3 modules	4 modules	specific covers	6 modules
	WHITE	KA4802KW	KA4803KW	KA4804KW	KA4814KW	KA4806KW
	GOLD	KA4802ZW	KA4803ZW	KA4804ZW	KA4814ZW	KA4806ZW
	MOON	KA4802NW	KA4803NW	KA4804NW	KA4814NW	KA4806NW
	ICE	KA4802DW	KA4803DW	KA4804DW	KA4814DW	KA4806DW
	SKY	KA4802DA	KA4803DA	KA4804DA	KA4814DA	KA4806DA
	PIXEL	KA4802MW	KA4803MW	KA4804MW	KA4814MW	KA4806MW
	BLACK	KA4802KG	KA4803KG	KA4804KG	KA48104KG	KA4806KG
	SPACE	KA4802NG	KA4803NG	KA4804NG	KA4814NG	KA4806NG
	STEEL	KA4802ZG	KA4803ZG	KA4804ZG	KA4814ZG	KA4806ZG
	WALNUT	KA4802LG	KA4803LG	KA4804LG	KA4814LG	KA4806LG
	NIGHT	KA4802DG	KA4803DG	KA4804DG	KA4814DG	KA4806DG
Supports						
		K4702	K4703	K4704	Provided with socket	K4706

COMPOSITION OF DIGITAL CONTROLS

For each type of box, the electrified frames used and the number of devices and the accessories that can be installed are indicated.

	2 modules	3 modules	4 modules		
Flush mounted boxes	 502E (70x70x50 mm)	 503E (108x74x53.5 mm)	 504E (133x74x53.5 mm)		
Plasterboard boxes	 PB502N (ø 71x50,5 mm)	 PB503N (110x71x52 mm)	 PB504N (132.5x71x52 mm)		
Supports	 K8102	 K4703 with screws	 K4704 with screws		
Flush mounted boxes - connection module K8001; - actuators K8002L and e K8002S; - additional power supply K8003 (2 modules).	*  3 modules		*  4 modules		
Blanking module K4950	 max. 2 blanking modules		 max. 3 blanking modules		
Electrified frame	 3 modules ..8102P1	 3 modules ..8103	 3+1 modules ..8103P1	 4 modules ..8104	 4+1 modules ..8104P1
Voice control item ..8013 (3 modules) Digital control Light item ..8010 and Full item ..8011 Cover for blanking module item 4950					

WARNING FOR THE SELECTION OF THE DEVICES:

- Note (*) The connection module is necessary; its position is free inside the box.
- If the installation of the additional power supply, item K8003, is required for the voice command, item8013 (see the MyHOME_Up guide for the details), connection module item K8001 must not be installed. The additional power supply (space required 2 modules) can only be installed in the electrified frame or together with 1 or 2 actuators, depending on the size of the box.

INSTALLATION EXAMPLE OF THE DIGITAL CONTROLS

Installation with flush-mounted actuator

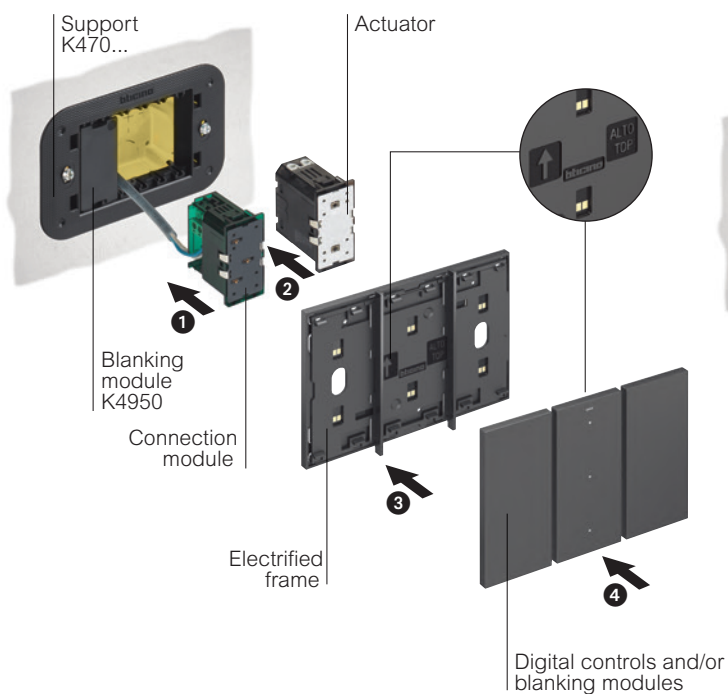

Use in conjunction with the connection module, or another actuator, to take up the power voltage.

Installation with actuator in DIN switchboard

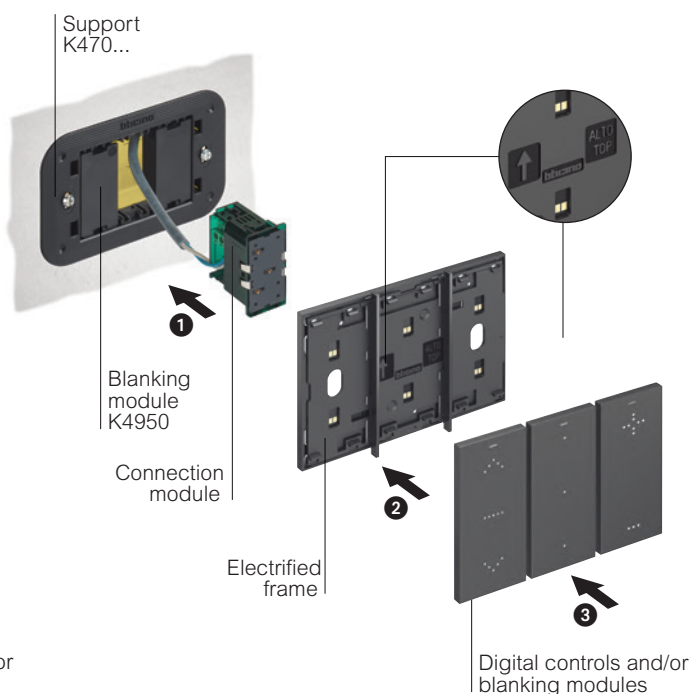

At the side of the connection module, install 2 false poles, item K4950, in any position.

Installation of the voice control

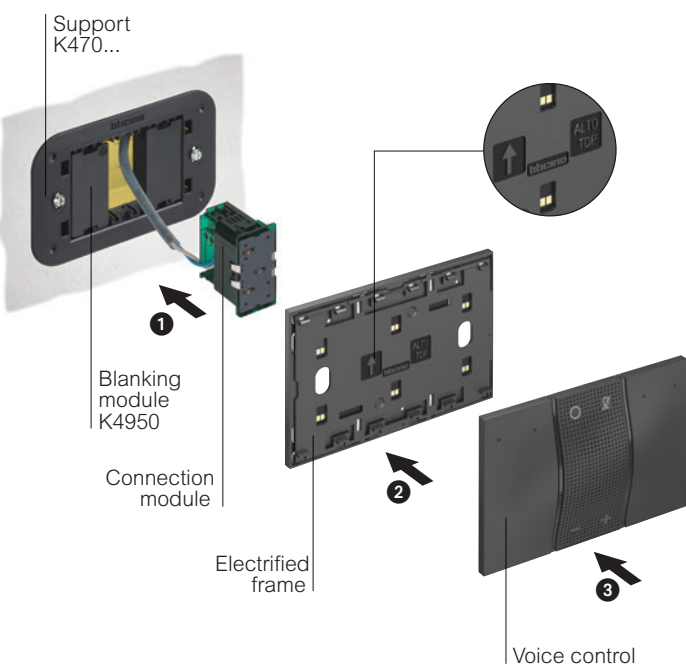

Remove the finishing bars from the electrified frame. When installing power supply item K8003, connection module item K8001 must not be used.

Living Now



TECHNICAL INFORMATION,
DIMENSIONAL DATA

Living Now

how to install the covers

LIGHT POINT INSTALLATION

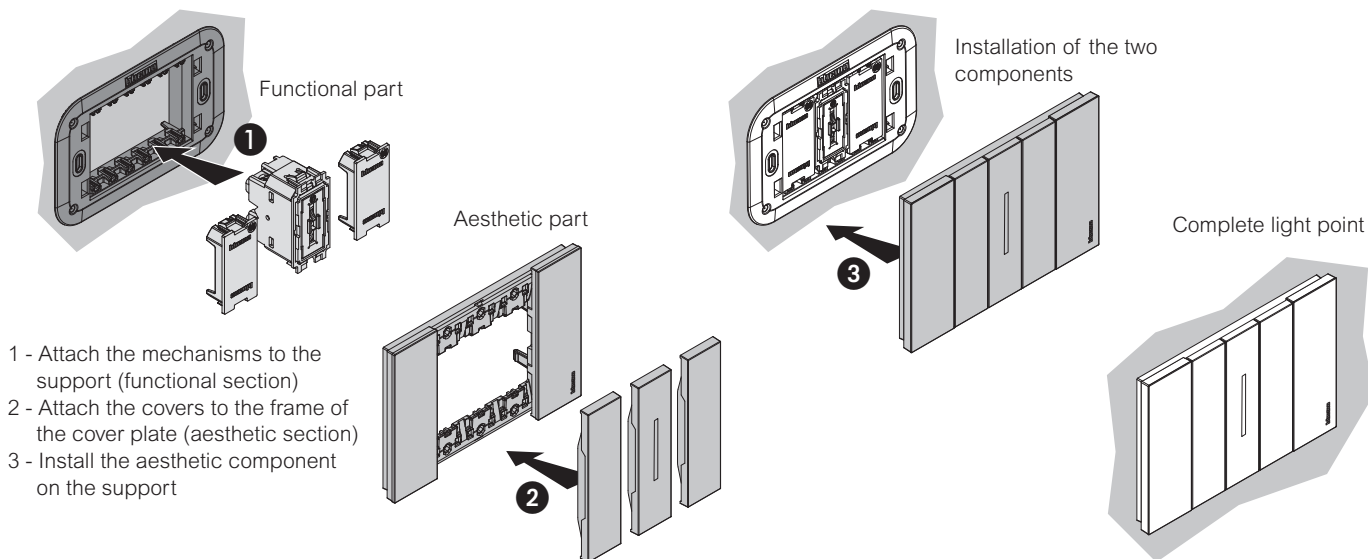

REMOVING MOBILE COVERS



Mobile covers are those that move in relation to the light point, to allow the activation of a control (traditional, connected or MyHOME_Up)

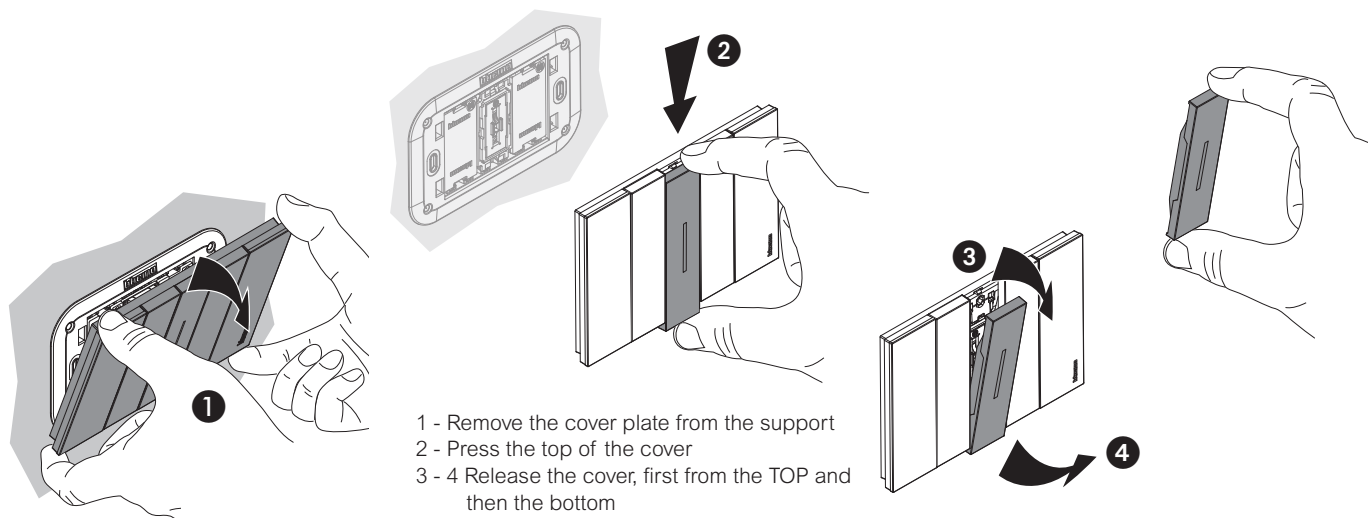

REMOVING FIXED COVERS



Fixed covers those are attached to the cover plates, such as for example blanking modules and all non-control devices (e.g. sockets, RJ connectors, TV sockets, USB chargers, etc.)

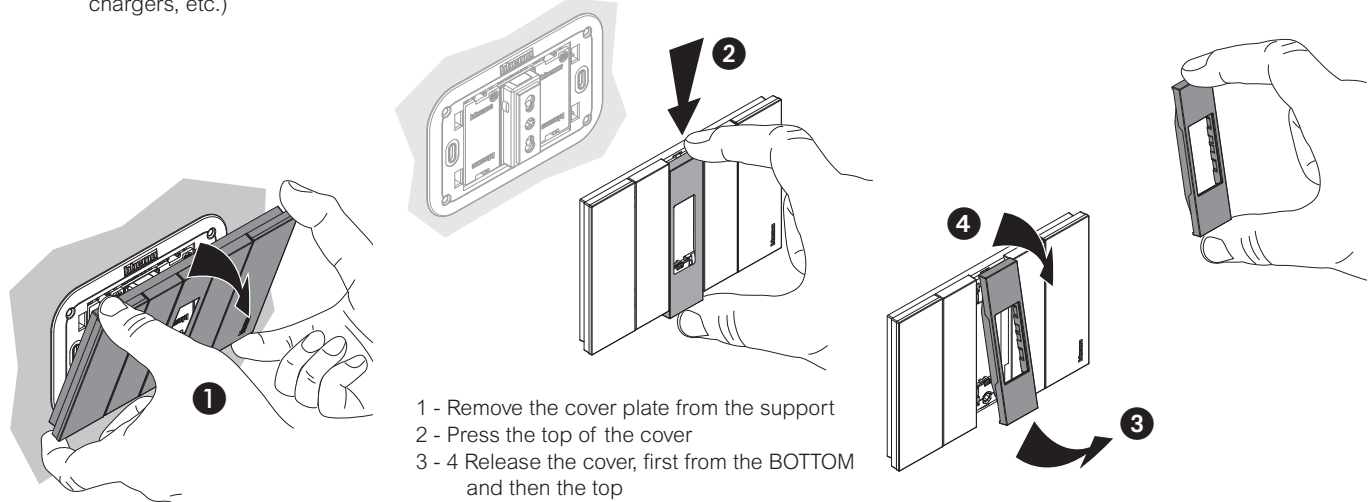

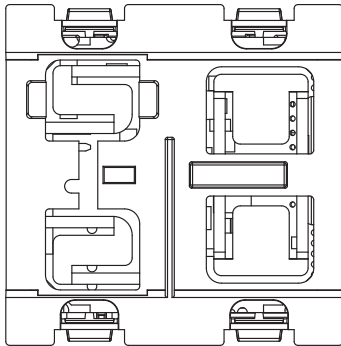

K4410
K4411

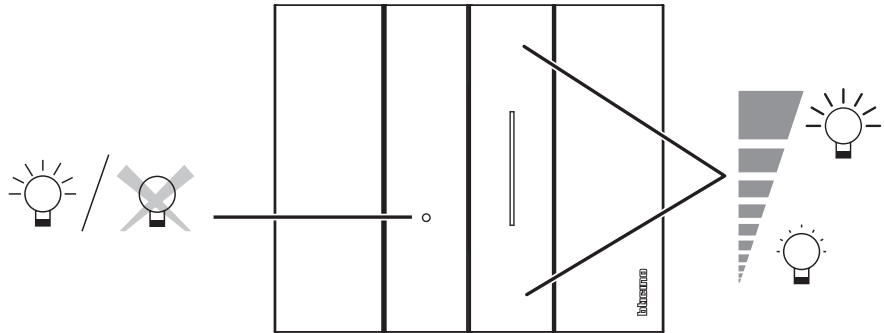

Switch the light on and off and bring the light to the desired level with a simple soft touch.
Possibility of setting different brightness levels.
ON/OFF notification LED.

DIMMER ITEM K4410 - TABLE OF MANAGED LOADS

		1 -10 V		
 240 V ~ 50/60 Hz		 	 	
	Max	600 VA	600 VA	600 VA
	Min.	20 VA	20 VA	20 VA

DIMMER ITEM K4411 - TABLE OF MANAGED LOADS

		R		L		C/L		
 240 V ~ 50/60 Hz		 	 	 	 	 	Can be dimmed 	Can be dimmed LED
	Max.	400 W	400 W	400 VA	200 VA	400 VA	200 VA	75 W or max. 10 lamps
	Min.	3 W	3 W	3 VA	3 VA	3 VA	3 W	3 W

Living Now
IR switches

IR SENSOR ITEM K4430 - TABLE OF MANAGED LOADS

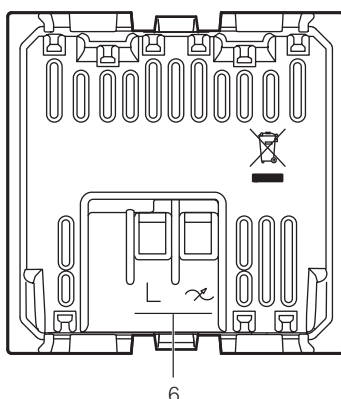
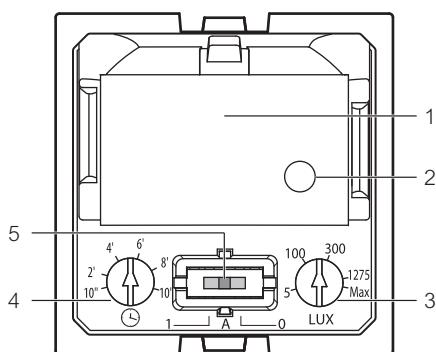

1. PIR sensor
2. Lighting sensor
3. Brightness adjustment
from 5 lux to 1275 lux
Max: Test mode
4. Timing adjustment
from 10 sec.* to 10 min.
5. ON - AUTO - OFF switch
1: forced switching ON
A: ON/OFF auto
0: forced switching OFF
6. Connection clamps

Table of managed loads

 		LED		Fluorescent compact		LED + Transformer		Transformer + Lamp		
		LED lamp		Fluorescent compact		Electronic transformer		Ferromagnetic transformer		
240 V ~ 50/60 Hz	Max. 250 W Min. 3 W	1 A 0.02 A	Max. 100 W Min. 3 W	0.4 A 0.02 A	Max. 100 W Min. 3 W	0.4 A 0.02 A	Max. 250 W Min. 3 W	1 A 0.02 A	Max. 250 W Min. 3 W	1 A 0.02 A

IR SENSOR ITEM K4432 - TABLE OF MANAGED LOADS

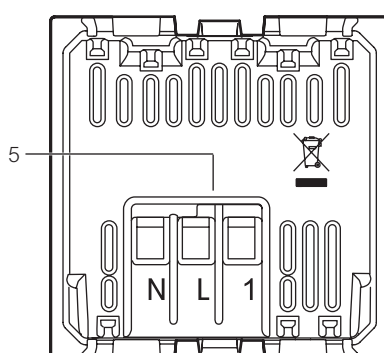
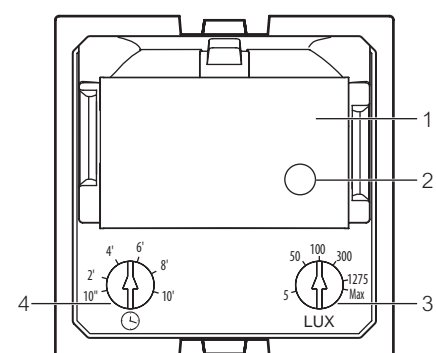

1. PIR sensor
 2. Lighting sensor
 3. Brightness adjustment
from 5 lux to 1275 lux*
Max: Test mode
 4. Timing adjustment
from 10 sec.* to 10 min.
 5. Connection clamps
- * Factory settings

Table of managed loads

 		LED		Fluorescent compact		LED + Transformer		Transformer + Lamp		
		LED lamp		Fluorescent compact		Electronic transformer		Ferromagnetic transformer		
240 V ~ 50/60 Hz	400 W	1.8 A	200 VA	0.8 A	200 VA	0.8 A	200 VA	0.8 A	200 VA	0.8 A

IR SENSOR ITEM K4431 - TABLE OF MANAGED LOADS

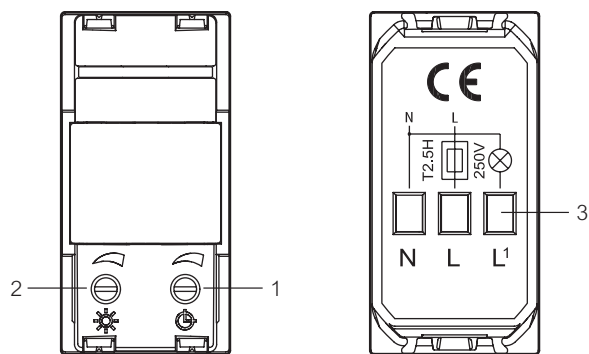

1. Switching off delay adjustment (*)
2. Twilight adjustment (**)
3. Connection clamps



Table of managed loads

 Loads 240 V ~ 50/60 Hz	 Filament lamp or halogen lamp		 Electronic transformer		 Fluorescent tube		 Fluorescent compact or LED lamp		 Motor (cos =0,5)		
		460 W	2 A	460 W	2 A	460 W	2 A	50 W	0.5 A	30 W	2 A

LED SAFETY LAMP< ITEM K4381 - AUTOMATIC OPERATION MODE SELECTION

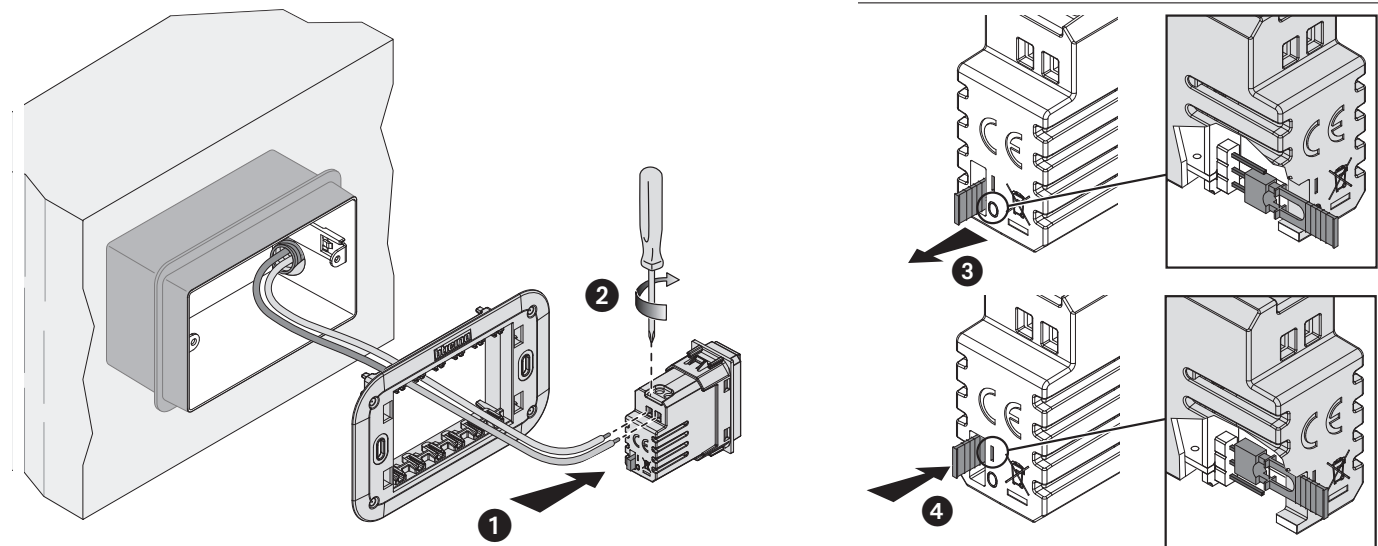

Technical features

Power supply	230 Va.c. , 50/60Hz
Consumption	2.5 VA (0.1 W)
Non-replaceable rechargeable battery	NiMH 3.6 V 140 mAh
Charging time	48 hours
Autonomy	2 hours
Maximum cable section	1 x 1.5 mm²
Light intensity	2400 mcd
Angle of emission	120°
Not pull-out	

Living Now

electronic thermostat

ELECTRONIC ROOM THERMOSTAT ITEM KW4441-KG4441-KM4441

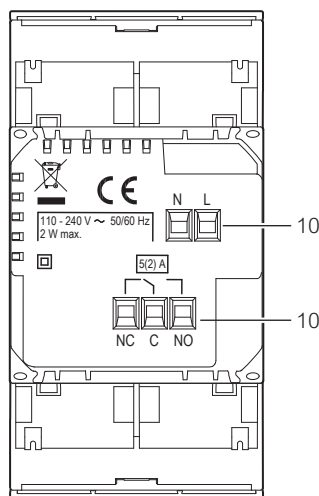
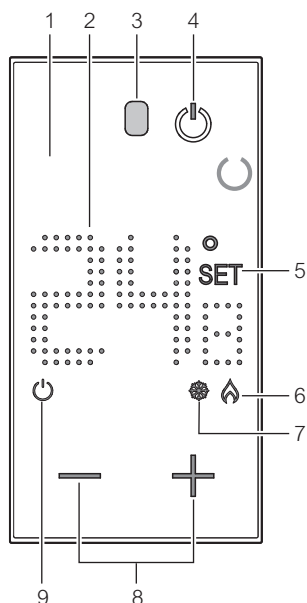

1. Backlit display
2. Temperature display
3. Lighting sensor
4. ON / OFF key sets the system (OFF) in anti-frost (7 °C) or heat-protection (35 °C) mode
5. Temperature setting indicator: appears when the temperature is being set
6. ON heating indicator
7. ON cooling indicator
8. Keys for temperature setting
9. OFF thermostat indicator
10. Connection clamps

Wiring diagrams

- System only for heating with clean contact (e.g. boiler activation) or heating and cooling with floor system

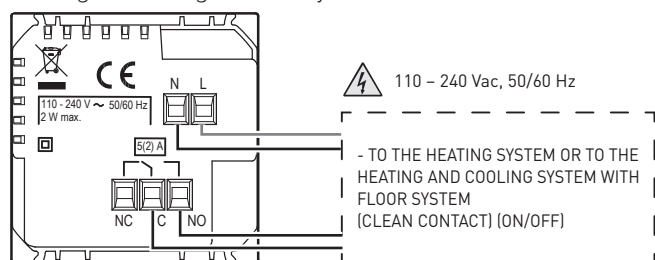

- Heating and cooling with different systems

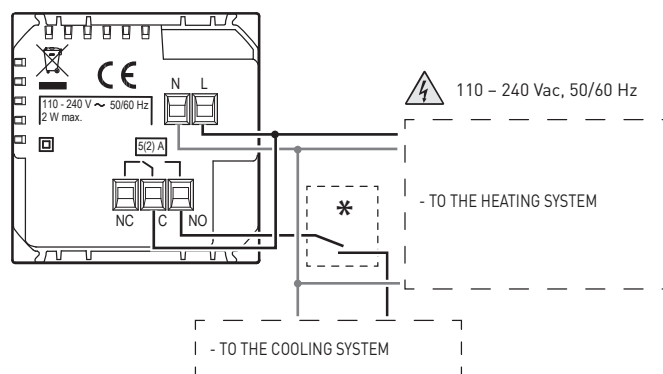

- System only for heating with load to be controlled to the mains voltage (e.g. 230Vac solenoid valve)

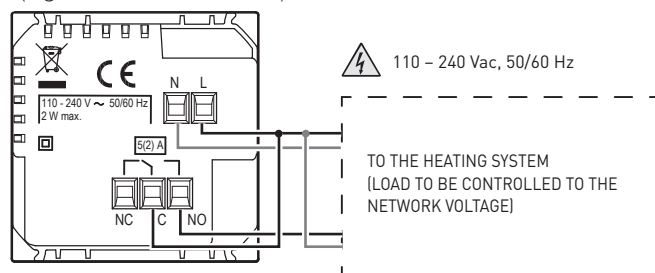

Technical features

Power supply	110 – 240 V~, 50/60 Hz
Absorption	2 W max
Maximum cable section	1 x 1.5mm ²
Operating temperatures	5 – 40 °C
Setpoint temperature	5 – 40 °C; increase of 0.5 °C
Type of operation	1BU
Pollution index	2
Rated pulse voltage	4 kV
Contact output	[5(2) A]

Technical features for all devices

Technology: ZigBee certified product, Zigbee 3.0 public profile
 Performance: 200 m range in a free point-to-point field
 Band frequency: from 2.4 to 2.4835 GHz

Connected TWO-WAY SWITCH ITEM K4003C

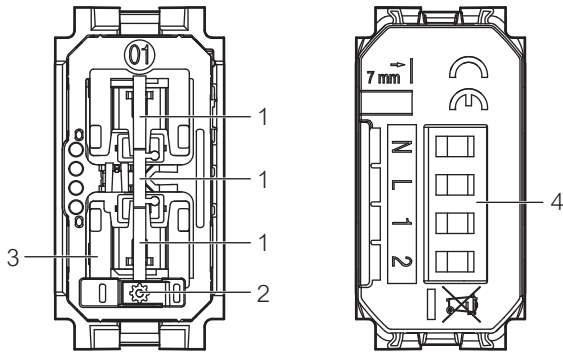

- 1 - Control pushbutton
- 2 - Setting pushbutton
- 3 - Notification LED
 - red steady: device not in Zigbee network
 - green steady: device in Zigbee network
- 4 - Connection clamps

Wiring diagram - interrupted

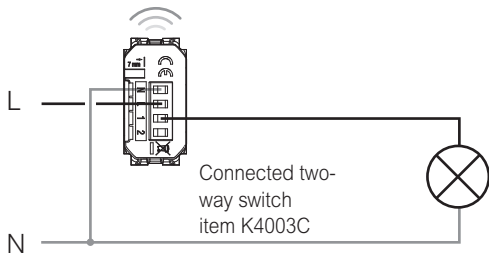

Wiring diagram - redirected or inverted

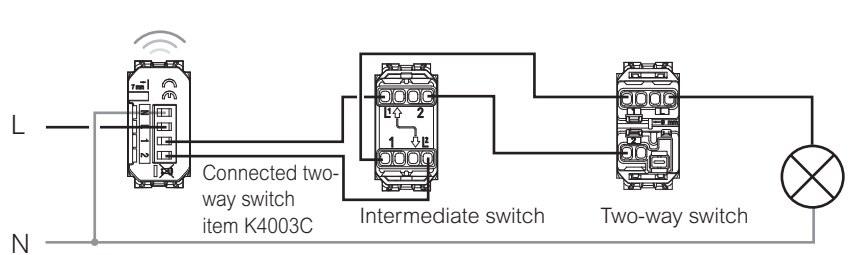
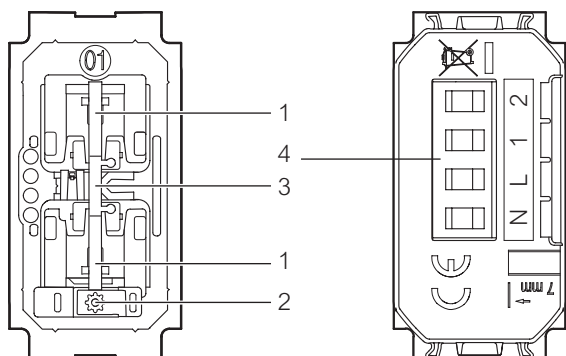

Table of managed loads

<p>+45°C +5°C 2x2,5mm²</p>		LED 			
Loads	Filament lamp or halogen lamp	LED lamp	Fluorescent compact	Electronic transformer	Ferromagnetic transformer
240 V~ 50/60 Hz	250 W	50 W	125 VA	125 VA	125 VA
Technology	ZigBee certified product, Zigbee 3.0 public profile				
Performances	200 m range in a free point-to-point field.				
Power level	REC 70-03: <20dBm				
Band frequency	from 2,4 to 2,4835 GHz				

Living Now
dimmer

DIMMER ITEM K/L/N/NT4411C



- 1 - Control pushbutton
- 2 - Reset pushbutton
- 3 - Notification LED
- 4 - Connection clamps

Basic diagram

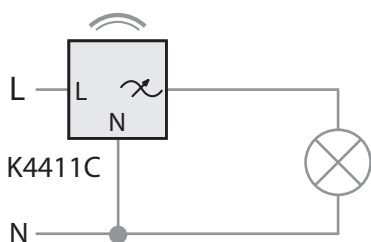
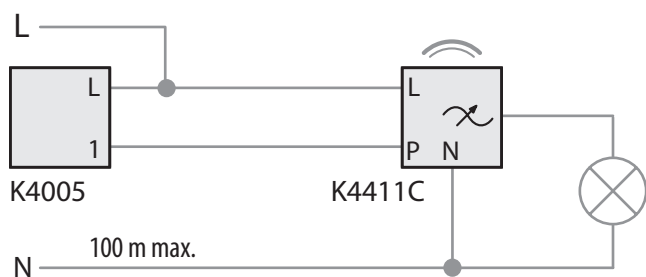

Diagram with remote control pushbuttons



Technical features

 110 – 240 V~, 50/60 Hz	 Filament lamp or halogen lamp	 LED lamp
Loads		
240 VAC	150 W	150 W
100 VAC	75 W	75 W
Technology	Radio (Wireless meshed network)	
Power level	< 100 mW	
Band frequency	from 2,4 to 2,4835 GHz	

SHUTTERS CONTROL ITEM K4027C

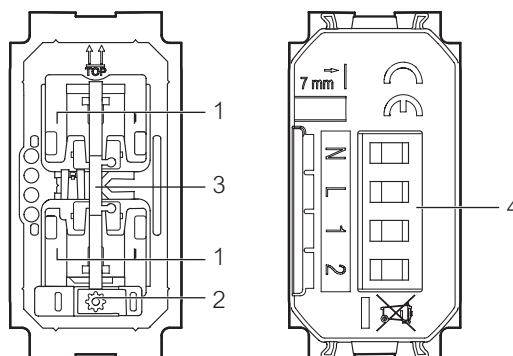

- 1 - Control pushbutton
- 2 - Reset pushbutton
- 3 - Notification LED
- 4 - Connection clamps

Wiring diagram - interrupted

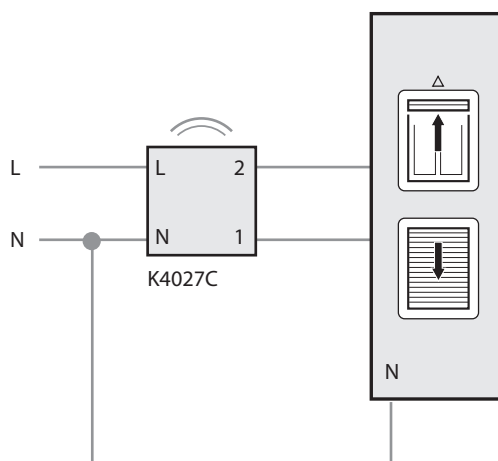

Warning: only compatible with standard motors (no pulse motors, no radio motors)

Technical features

 110 – 240 V~, 50/60 Hz	
Loads	Motor for shutters
240 VAC max.	1 x 500 VA
100 VAC max.	1 x 270 VA
Technology	Radio (Wireless meshed network)
Power level	< 100 mW
Band frequency	from 2,4 to 2,4835 GHz

CONNECTED LIGHT RELAY ITEM 3584C

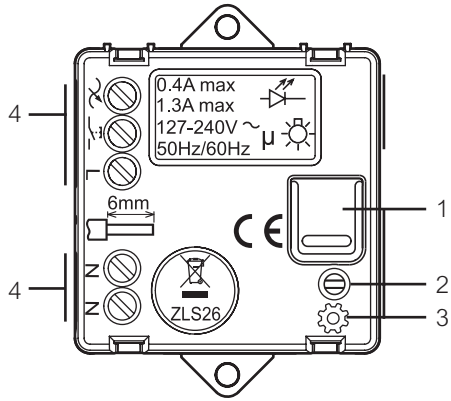

- 1 - Control pushbutton
- 2 - Setting pushbutton
- 3 - Notification LED
 - red steady: device not in Zigbee network
 - green steady: device in Zigbee network
- 4 - Connection clamps

Wiring diagram

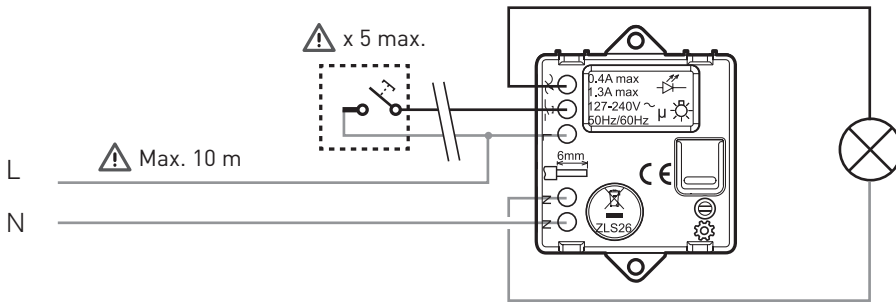

Option: remote control through mechanical pushbutton, not luminous.

Table of managed loads

		R			L	
		Filament lamp or halogen lamp LED lamp Fluorescent compact Electronic transformer Ferromagnetic transformer	LED lamp Fluorescent compact Electronic transformer Ferromagnetic transformer	Fluorescent compact Electronic transformer Ferromagnetic transformer	Electronic transformer Ferromagnetic transformer	Ferromagnetic transformer
240 V ~ 50/60 Hz Max.	300 W (*) 100 W 250 VA 250 VA 250 VA	300 W (*) 100 W 250 VA 250 VA 250 VA	(*) 100 W 250 VA 250 VA 250 VA 250 VA	250 VA 250 VA 250 VA 250 VA 250 VA	250 VA 250 VA 250 VA 250 VA 250 VA	250 VA 250 VA 250 VA 250 VA 250 VA

* or 10 maxi. lamps

** warning: ferromagnetic transformers must be charged at over 60% of their rated power.

CONNECTED MODULE FOR SOCKET ITEM K4531C

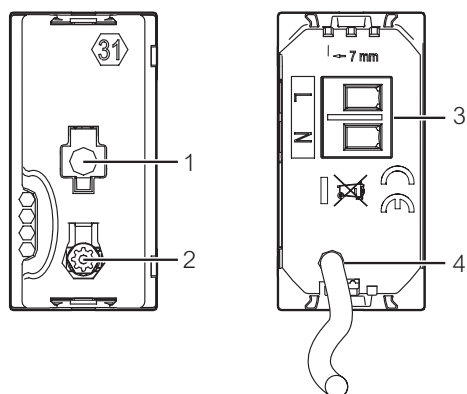

- 1 - notification LED
 - red steady: device not in Zigbee network
 - green steady: device in Zigbee network
- 2 - Setting pushbutton
- 3 - Connection clamps
- 4 - load controlled phase cable

Wiring diagram

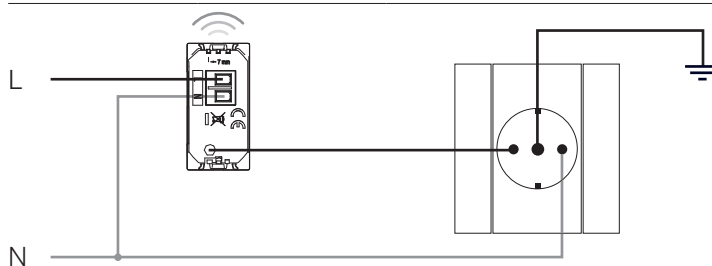
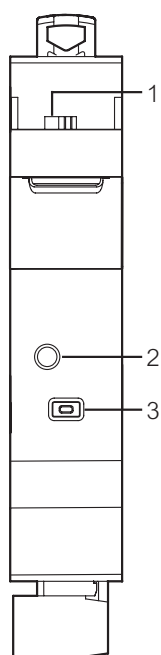

Table of managed loads

+45°C +5°C 2x2,5mm ²								
Loads	Filament lamp	Halogen lamp	Electronic transformer	Ferromagnetic transformer	Fluorescent tube	Fluorescent compact	LED lamp	Ventilation motor
230 Va.c. 3800 W cos 0,8	16 A							

CONNECTED DIN METER ITEM F20T60A



- 1 - Toroid connection
- 2 - notification LED
- 3 - Network association pushbutton

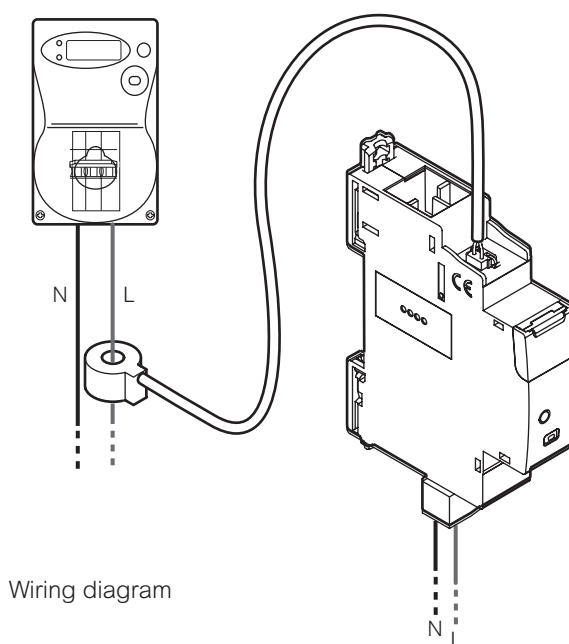

Wiring diagram

Living Now cover plates (3 module area system)

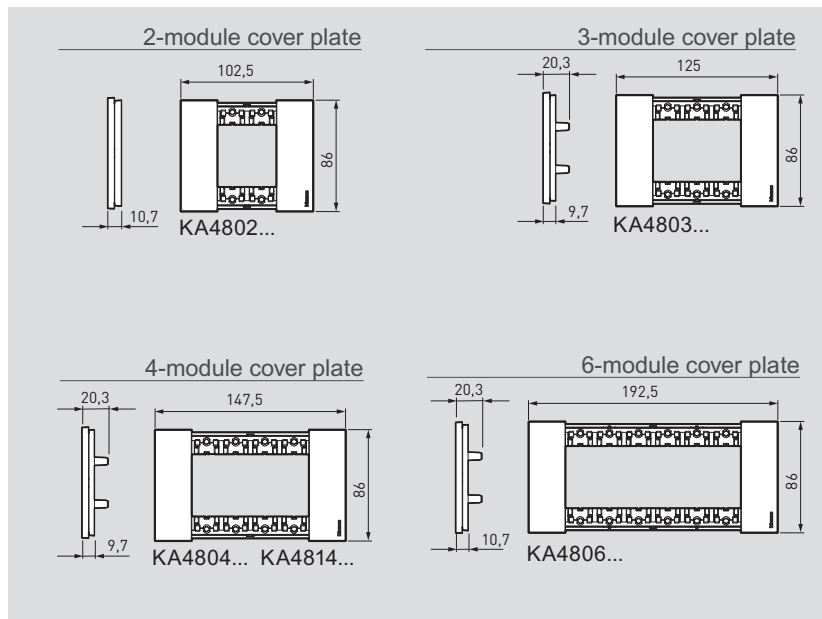

Living Now supports (3 module area system)

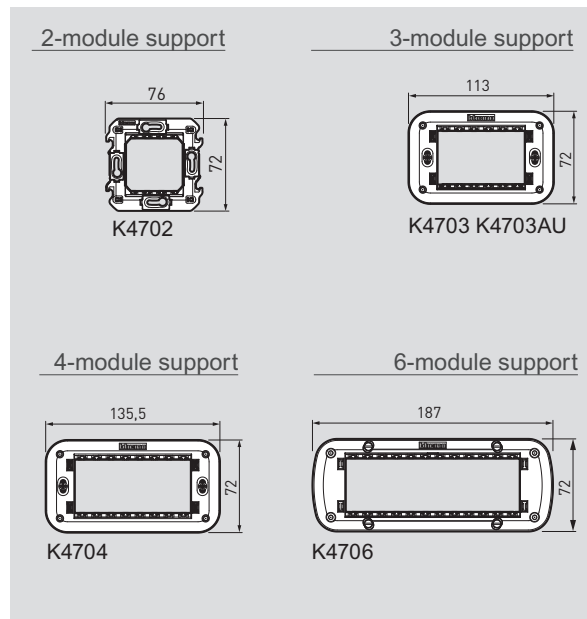

Living Now cover plates (2 module area system)

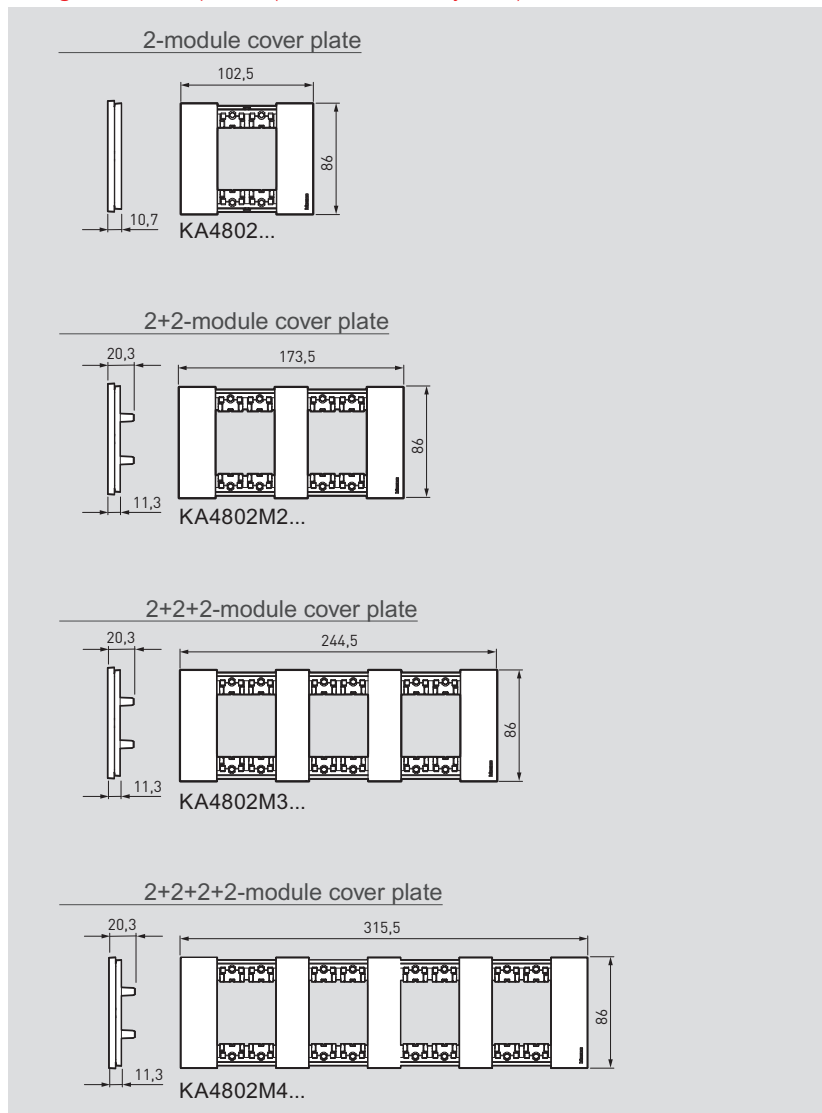

Living Now support (2 module area system)

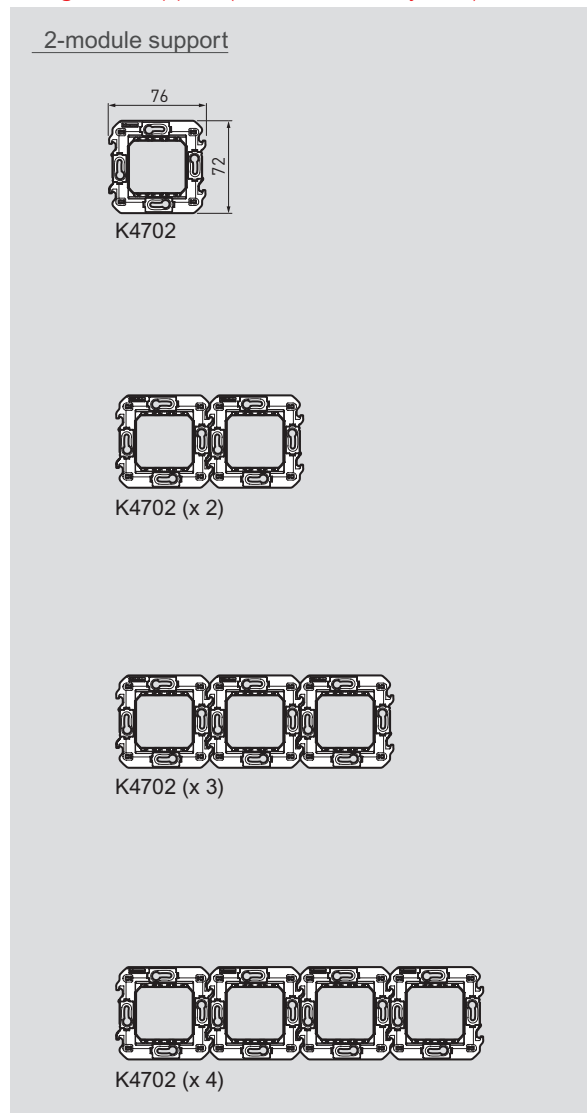

Living Now MyHOME_Up electrified frames

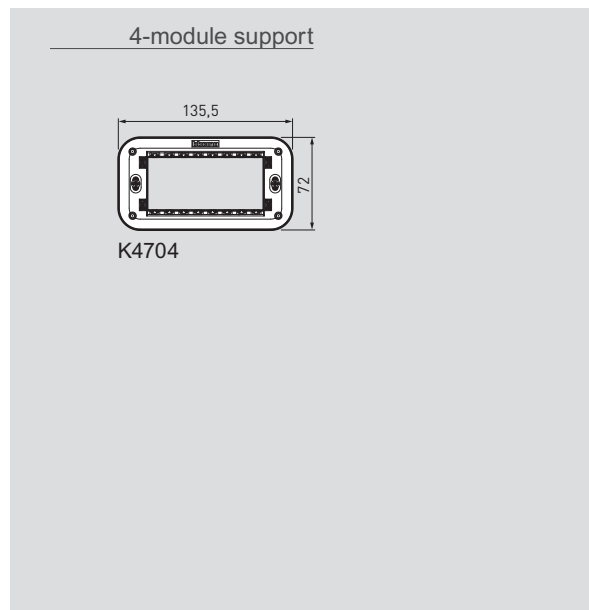
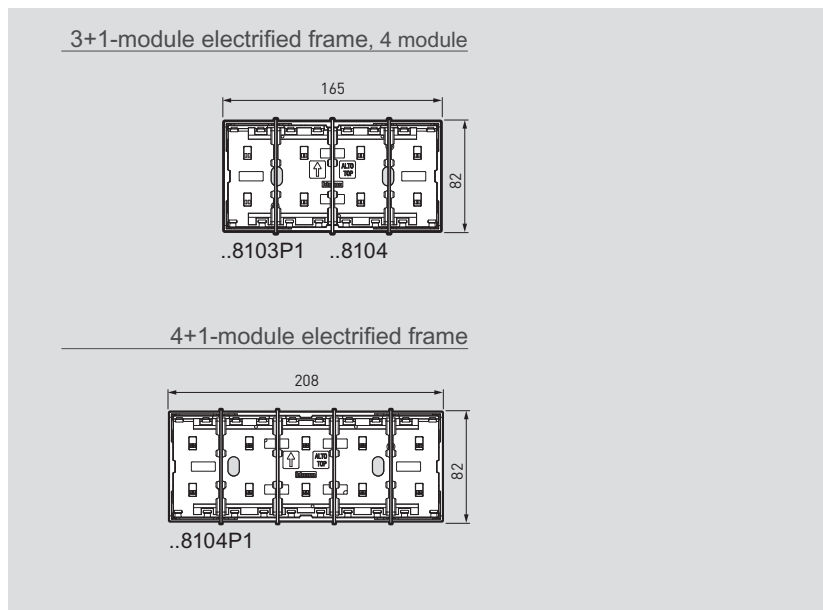
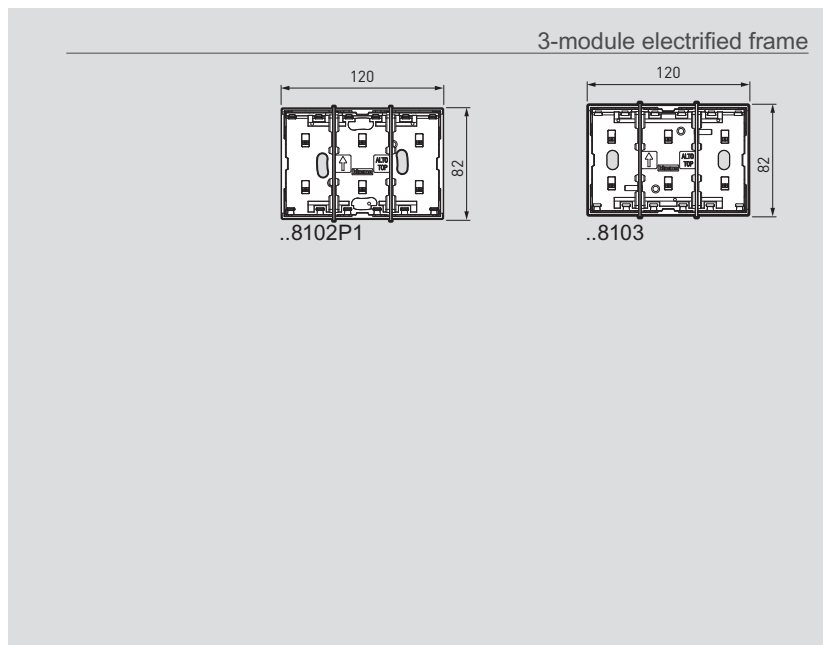

Smarter with Netatmo

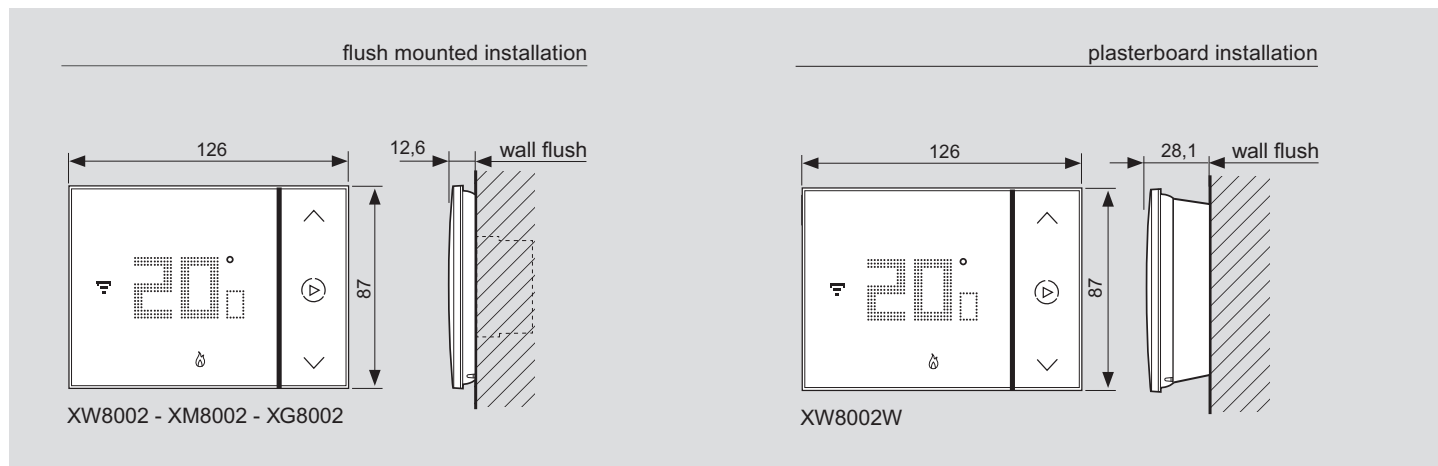

BTicino SpA
Viale Borri, 231
21100 Varese - Italy
www.bticino.com

BTicino S.p.A. reserves at any time the right to modify the contents of this booklet and to communicate, in any form and modality, the changes brought to the same.

AD-EXLW21C/GB – Edition 02/2021