

LED&ILLUMINAZIONE

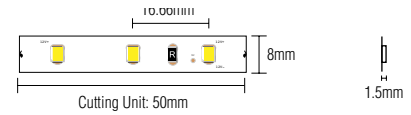

DJ60-12V-8mm

DJ60WW812-IP20	SMD2835, 60LEDs/m, 12V/DC, 4.8W, 3000K
DJ60NW812-IP20	SMD2835, 60LEDs/m, 12V/DC, 4.8W, 4000K
DJ60W812-IP20	SMD2835, 60LEDs/m, 12V/DC, 4.8W, 6000K
DJ60WW812-IP55	SMD2835, 60LEDs/m, 12V/DC, 4.8W, 3000K
DJ60NW812-IP55	SMD2835, 60LEDs/m, 12V/DC, 4.8W, 4000K
DJ60W812-IP55	SMD2835, 60LEDs/m, 12V/DC, 4.8W, 6000K



DJ860-12V-10mm

D860WW812-IP20	SMD2835, 60LEDs/m, 12V/DC, 7.2W, 3000K
D860NW812-IP20	SMD2835, 60LEDs/m, 12V/DC, 7.2W, 4000K
D860W812-IP20	SMD2835, 60LEDs/m, 12V/DC, 7.2W, 6000K
D860WW812-IP55	SMD2835, 60LEDs/m, 12V/DC, 7.2W, 3000K
D860NW812-IP55	SMD2835, 60LEDs/m, 12V/DC, 7.2W, 4000K
D860W812-IP55	SMD2835, 60LEDs/m, 12V/DC, 7.2W, 6000K

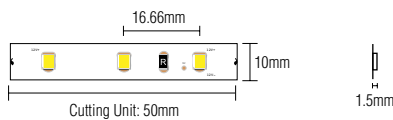

DJ120-12V-8mm

DJ120WW812-IP20	SMD2835, 120LEDs/m, 12V/DC, 9.6W, 3000K
DJ120NW812-IP20	SMD2835, 120LEDs/m, 12V/DC, 9.6W, 4000K
DJ120W812-IP20	SMD2835, 120LEDs/m, 12V/DC, 9.6W, 6000K
DJ120WW812-IP55	SMD2835, 120LEDs/m, 12V/DC, 9.6W, 3000K
DJ120NW812-IP55	SMD2835, 120LEDs/m, 12V/DC, 9.6W, 4000K
DJ120W812-IP55	SMD2835, 120LEDs/m, 12V/DC, 9.6W, 6000K

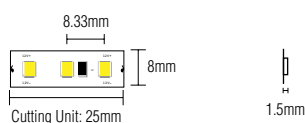

D8120-12V-8mm

D8120WW812A-IP20	SMD2835, 120LEDs/m, 12V/DC, 14.4W, 3000K
D8120NW812A-IP20	SMD2835, 120LEDs/m, 12V/DC, 14.4W, 4000K
D8120W812A-IP20	SMD2835, 120LEDs/m, 12V/DC, 14.4W, 6000K
D8120WW812A-IP55	SMD2835, 120LEDs/m, 12V/DC, 14.4W, 3000K
D8120NW812A-IP55	SMD2835, 120LEDs/m, 12V/DC, 14.4W, 4000K
D8120W812A-IP55	SMD2835, 120LEDs/m, 12V/DC, 14.4W, 6000K



D872-12V-6mm

D8721206NO-8WW-IP20-BENDABLE	SMD2835, 72LEDs/m, 12V/DC, 5.8W, 3000K
D8721206NO-8NW-IP20-BENDABLE	SMD2835, 72LEDs/m, 12V/DC, 5.8W, 4000K

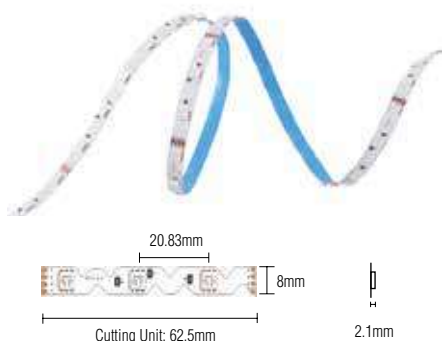
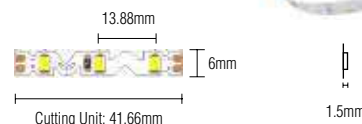

D548RGB-12V-8mm

D5481208NO-RGB-IP20-BENDABLE SMD2835, 48LEDs/m, 12V/DC, 8W, RGB

D530RGB-12V-10mm

D530RGB-12-10-IP20	SMD2835, 30LEDs/m, 12V/DC, 7.2W, RGB
D530RGB-12-10-IP55	SMD2835, 30LEDs/m, 12V/DC, 7.2W, RGB

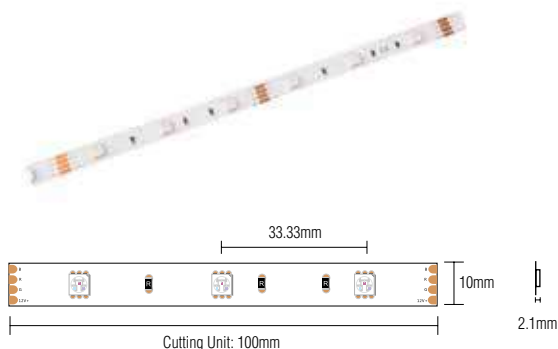



D560RGB-12V-10mm

D560RGB-12-10-IP20 SMD2835, 60LEDs/m, 12V/DC, 14,4W, RGB

D560RGB-12-10-IP55 SMD2835, 60LEDs/m, 12V/DC, 14,4W, RGB

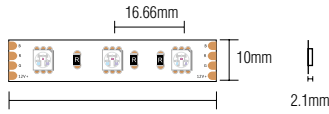

DJ60-24V-8mm



DJ60SW824-IP20 SMD2835, 60LEDs/m, 24V/DC, 4.8W, 2700K

DJ60WW824-IP20 SMD2835, 60LEDs/m, 24V/DC, 4.8W, 3000K

DJ60NW824-IP20 SMD2835, 60LEDs/m, 24V/DC, 4.8W, 4000K

DJ60W824-IP20 SMD2835, 60LEDs/m, 24V/DC, 4.8W, 6000K

DJ60WW824-IP55 SMD2835, 60LEDs/m, 24V/DC, 4.8W, 3000K

DJ60NW824-IP55 SMD2835, 60LEDs/m, 24V/DC, 4.8W, 4000K

DJ60W824-IP55 SMD2835, 60LEDs/m, 24V/DC, 4.8W, 6000K

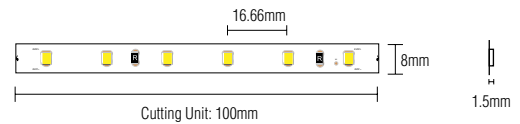

D860-24V-8mm



D860WW824-IP20 SMD2835, 60LEDs/m, 24V/DC, 7.2W, 3000K

D860NW824-IP20 SMD2835, 60LEDs/m, 24V/DC, 7.2W, 4000K

D860W824-IP20 SMD2835, 60LEDs/m, 24V/DC, 7.2W, 6000K

D860WW824-IP55 SMD2835, 60LEDs/m, 24V/DC, 7.2W, 3000K

D860NW824-IP55 SMD2835, 60LEDs/m, 24V/DC, 7.2W, 4000K

D860W824-IP55 SMD2835, 60LEDs/m, 24V/DC, 7.2W, 6000K

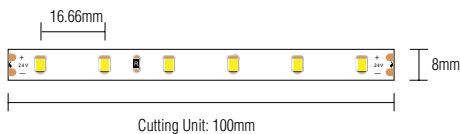

DJ120-24V-8mm



DJ120SW824-IP20	SMD2835, 120LEDs/m, 24V/DC, 9.6W, 2700K
DJ120WW824-IP20	SMD2835, 120LEDs/m, 24V/DC, 9.6W, 3000K
DJ120NW824-IP20	SMD2835, 120LEDs/m, 24V/DC, 9.6W, 4000K
DJ120W824-IP20	SMD2835, 120LEDs/m, 24V/DC, 9.6W, 6000K
DJ120WW824-IP55	SMD2835, 120LEDs/m, 24V/DC, 9.6W, 3000K
DJ120NW824-IP55	SMD2835, 120LEDs/m, 24V/DC, 9.6W, 4000K
DJ120W824-IP55	SMD2835, 120LEDs/m, 24V/DC, 9.6W, 6000K

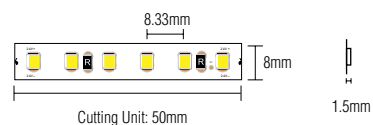

DR8160-24V-8mm



DR8160SW824A-IP20	SMD2835, 160LEDs/m, 24V/DC, 14.4W, 2700K
DR8160WW824A-IP20	SMD2835, 160LEDs/m, 24V/DC, 14.4W, 3000K
DR8160NW824A-IP20	SMD2835, 160LEDs/m, 24V/DC, 14.4W, 4000K
DR8160W824A-IP20	SMD2835, 160LEDs/m, 24V/DC, 14.4W, 6000K
DR8160WW824A-IP55	SMD2835, 160LEDs/m, 24V/DC, 14.4W, 3000K
DR8160NW824A-IP55	SMD2835, 160LEDs/m, 24V/DC, 14.4W, 4000K
DR8160W824A-IP55	SMD2835, 160LEDs/m, 24V/DC, 14.4W, 6000K

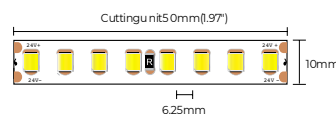

DJ240-24V-10mm



DJ2402410N0-8WWCDA12WC0500-IP20	SMD2835, 240LEDs/m, 24V/DC, 19.2W, 3000K
DJ2402410N0-8NWCDA12WC0500-IP20	SMD2835, 240LEDs/m, 24V/DC, 19.2W, 4000K
DJ2402410N0-8WCDA12WC0500-IP20	SMD2835, 240LEDs/m, 24V/DC, 19.2W, 6000K

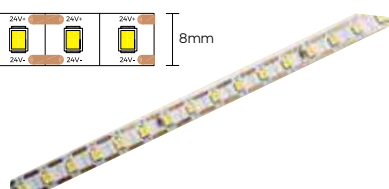
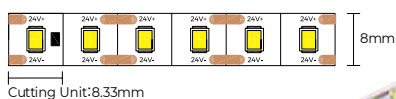
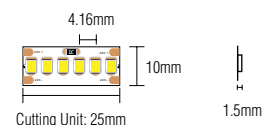

CR8120-24V-8mm



CR8120-24V-8LV-IP20	SMD 2835, 120 LEDs/m, 24v/DC, 9,6W, 2300K
----------------------------	---

D530RGB-24V-8mm

D530RGB-24-10-IP20 SMD5050, 30LEDs/m, 24V/DC, 7,2W, RGB

D530RGB-24-10-IP55 SMD5050, 30LEDs/m, 24V/DC, 7,2W, RGB

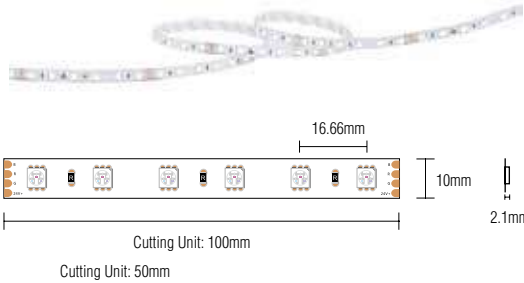
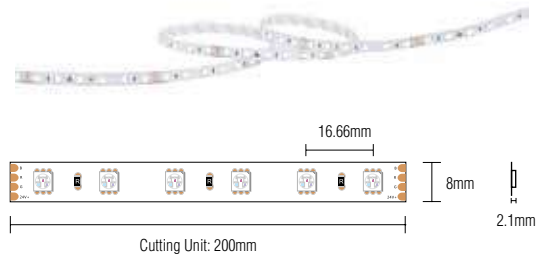

D560RGB-24V-10mm

D560RGB-24-10-IP20 SMD5050, 60LEDs/m, 24V/DC, 14,4W, RGB

D560RGB-24-10-IP55 SMD5050, 60LEDs/m, 24V/DC, 14,4W, RGB

DA120RGB 24V-8mm

DA120RGB 24V-8mm IP20 SMD5050, 60LEDs/m, 24V/DC, 11W, RGB

DA120RGB 24V-8mm IP65 SMD5050, 60LEDs/m, 24V/DC, 11W, RGB

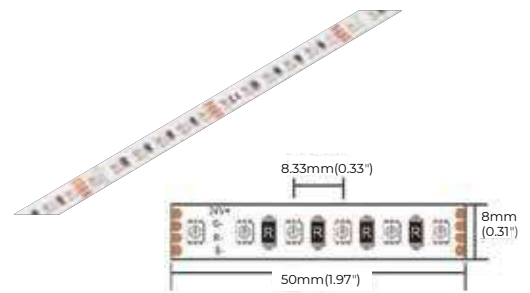

D560RGBW-24V-12mm

D560RGBWW024C-IP20 SMD5050, 60LEDs/M, 24VDC, 19.2W, RGB+3000K, FPC with 12mm, 5M/Reel

D560RGBNW024C-IP20 SMD5050, 60LEDs/M, 24VDC, 19.2W, RGB+4000K, FPC with 12mm, 5M/Reel

D560RGBW024C-IP20 SMD5050, 60LEDs/M, 24VDC, 19.2W, RGB+6000K, FPC with 12mm, 5M/Reel

D560RGBWW024C-IP65 NANO SMD5050, 60LEDs/M, 24VDC, 19.2W, RGB+3000K, FPC with 12mm, 5M/Reel

D560RGBNW024C-IP65 NANO SMD5050, 60LEDs/M, 24VDC, 19.2W, RGB+4000K, FPC with 12mm, 5M/Reel

D560RGBNW024C-IP65 NANO SMD5050, 60LEDs/M, 24VDC, 19.2W, RGB+6000K, FPC with 12mm, 5M/Reel

- 15m driven by one end, consistent brightness
- Suitable for use in large venue as entertaining lighting
- One-stop solution

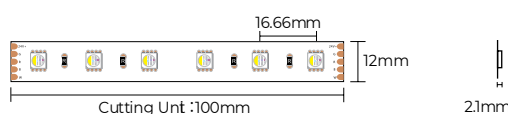

DP6RGBW-24V-12mm

DP6RGBW-24V-12mm 24V, 19,2W, IP20, RGB plus, 3000K

- High density RGBW LEDs
- Free connecting by soldering-free connectors
- 5 years warranty

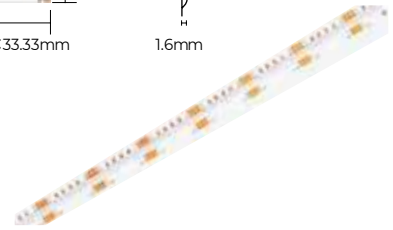
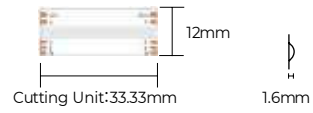

DRF6-24V-8mm

DRF6-24V-8mm COF 7,2W, 2700K, 24VDC, IP20 / DRF6-24V-8mm

DRF6-24V-8mm COF 7,2W, 4000K, 24VDC, IP20 / DRF6-24V-8mm

- Reel to reel process, no soldering joint.
- Light line and free with big emitting angle.
- 4 optional 2700K/3000K/4000K/6500K.
- suit for furniture lighting and decorative lighting application.

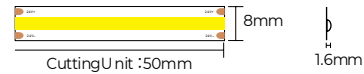

DF8-24V-8mm, DF8ET-24V-8mm

DF8-24W-8WW-IP20 COF LED, 24V/DC, 11.2W, 2700K

DF8-24W-8NW-IP20 COF LED, 24V/DC, 11.2W, 4000K

DF8ET-24W-8WW-IP65 COF LED, 24V/DC, 11.2W, 2700K

DF8ET-24W-8NW-IP65 COF LED, 24V/DC, 11.2W, 4000K

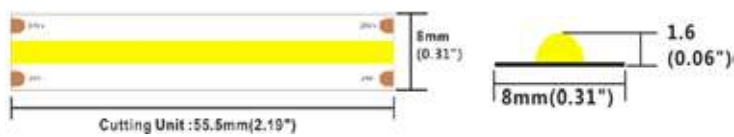

DP7 24V-4mm

DP7 24V-4mm COF 24V 9W/m DP7-4mm, 2700K, IP20

DP7 24V-4mm COF 24V 9W/m DP7-4mm, 4000K, IP20

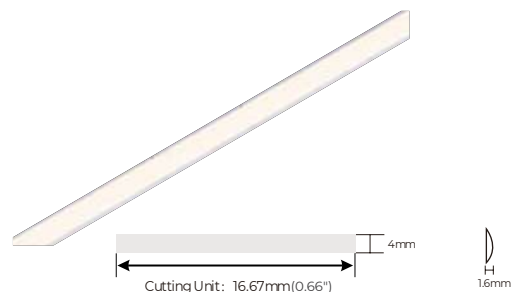

DS560-12V-10mm

- 12V single point single control, 60pixel/M SPI signal
- Built-in IC, continuous transmission even when 1 light bead gets broken
- Suitable for small & independent application
- 2-year warranty

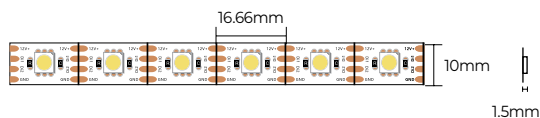

DS560RGB-12V-10mm

- 12V single point single control, 60pixel/M SPI signal
- Built-in IC, continuous transmission even when 1 light bead gets broken
- Suitable for small & independent application
- 2-year warranty

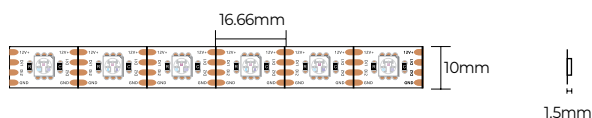

LED DIGITAL CONTROLLER SPI - M16S

Product parameter:

SPI-16S Controller :

Power Input:	5~24Vdc
Output:	SPI
Wireless Signal:	RF 2.4GHz
Working Temperature:	-30°C~55°C
Pixel Range :	8~1020px
Dimensions:	L135xW30xH20(mm)

M16S Remote :

Working Voltage:	3V (battery CR2032)
Wireless Signal:	RF 2.4GHz
Changing Mode:	16 kinds
Working Temperature:	-30°C~55°C
Dimensions:	L104xW58xH9(mm)
Weight(N.W.):	42g

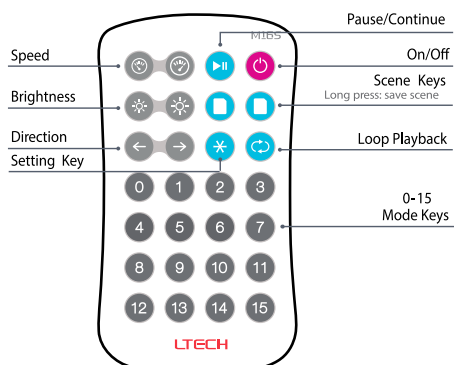

- | | |
|------------------------------|-------------------------|
| ① 7 colors jump | ⑧ 6 colors trail |
| ② 7 colors flash | ⑨ 6 colors circle trail |
| ③ 7 colors fade | ⑩ Gradients trail |
| ④ 7 colors smooth | ⑪ White meteor |
| ⑤ 7 colors horse race | ⑫ 6 colors float |
| ⑥ 7 colors circle horse race | ⑬ 6 colors double trail |
| ⑦ 7 colors flow | ⑭ Color white float |
| ⑧ 7 colors gradients flow | ⑮ Bi-color float |

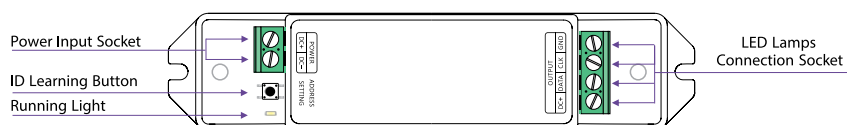

NEON TRAKE

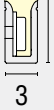
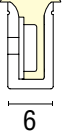
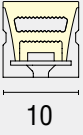
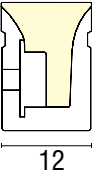
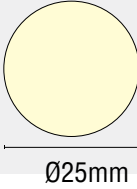
Size	Model	DC(V)	Color	Typ.W/m	LM/m*	CRI	LEDs/cut(mm)	Lenght(mm)	IP
 6mm	NMS0306	24	2700 K 4000 K	7.2	260	>90	7/35.7	5	IP54
 12mm	NJS0612T	24	2700 K 4000 K	8.8	330	>80	6/50	5	IP65
 10mm	NJT1010	24	2700 K 4000 K 5500 K	8.8	770	>80	6/50	5	IP65
 17mm	NMS1217	24	2700 K 4000 K RGB	9.6	420	>90	7/50	5	EP(IP67)
 Ø25mm	NNR25	24	2700 K 4000 K	14.4	950	>90	FREE CUTTING	5	IP65

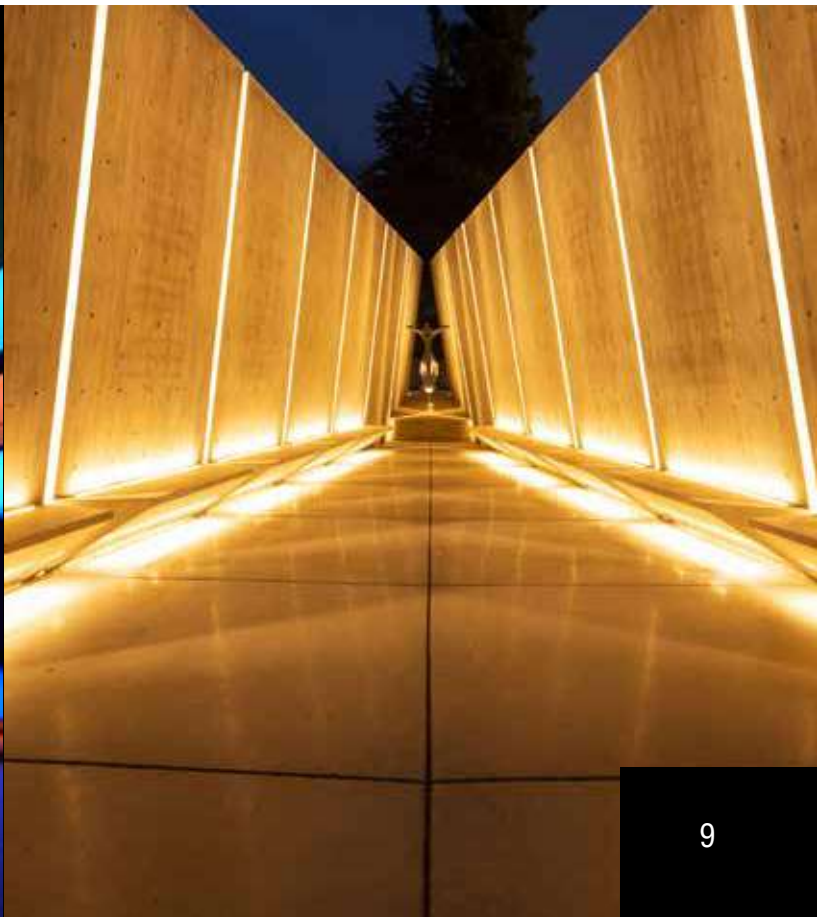

NMS0306

- G** **A T G** **NMS0306 NEON FLEX 2700K 24V** 2700K, 5m
- G** **A T G** **NMS0306 NEON FLEX 4000K 24V** 4000K, 5m

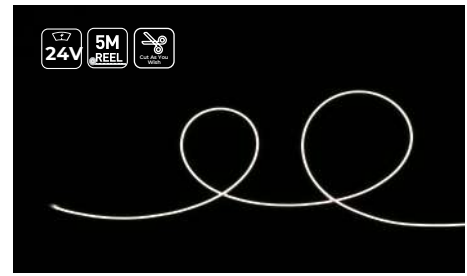
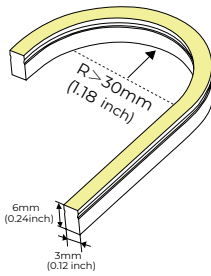

Basic Parameters

Series	Cutting unit	Input voltage	Input current	Typ. power	Size
White Light	7LED/35.7mm	DC24V	0.37A	7.2W	5m
Bend radius	>30mm				

Photo-electric Parameters

CRI	CCT	LM/m	LM/W
> 90	2700 K	215	30
	4000 K	260	40

NJS0612T

- G** **A T G** **NJS0612T-8SW24CSN050CC0500** 2700K, 5m
- G** **A T G** **NJS0612T-8NW24CSN050CC0500** 4000K, 5m

AS-NMS0612GH0-EC

METAL END CAP

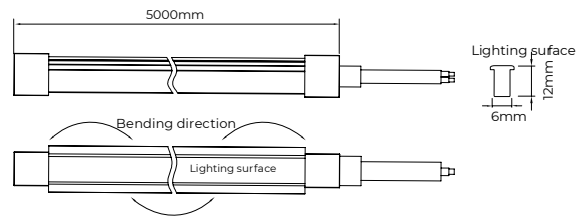

Basic Parameters

Series	Cutting unit	Input voltage	Input current	Typ. power	Size
White Light	6LED/50mm	DC24V	0.37A	8.8W	5m
Bend radius	>30mm				

Photo-electric Parameters

CRI	CCT	LM/m	LM/W
>80	2700 K	280	30
	4000 K	330	40



METAL END CAP

NJT1010

- G** **A T G** **NJT1010-8SW24CSN050CC0500-ESD** 2700K, 5m
- G** **A T G** **NJT1010-8NW24CSN050CC0500-ESD** 4000K, 5m
- G** **A T G** **NJT1010-8DW24CSN050CC0500-ESD** 5000K, 5m

- Typ. power: 8.8W/M, Voltage: 24V, CRI: Ra80, IP: gluing end cap (IP65), Entry Cable: One-end top, Wire Length: 50cm, Wire Type: PVC wire, ESD: YES, Type: COLORS

Basic Parameters

Series	Cutting unit	Input voltage	Input current	Typ. power	Size
White Light	6LED/50mm	DC24V	0.37A	8.8W	5m
Bend radius	>60mm				

Photo-electric Parameters

CRI	CCT	LM/m	LM/W
>80	2700 K	670	80
	4000 K	770	90
	5500 K	710	82

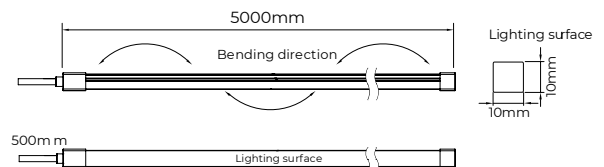
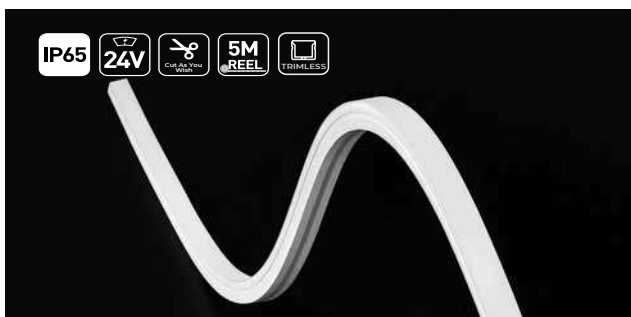

2700K

4000K

5000K

3-year indoor & 2-year outdoor warra

NMS1217

NMS1217-2700K



NMS1217-4000K



NMS1217-RGB

NMS1217MX0-FL konektor LED neon spojni

NMS1217HT0-FL konektor LED neon pocetni

NMT1217A 1m profile

NMS1217A-25 clips-front neon aluminium clips

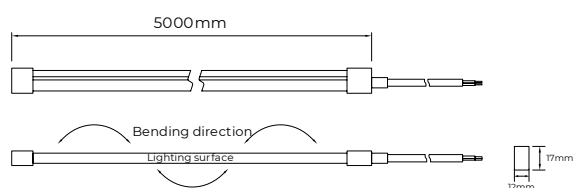

NMS1217-2700K



NMS1217-RGB



NMS1217MX0-FL



NMS1217HT0-FL

Basic Parameters

Series	Cutting unit	Input voltage	Input current	Typ. power	Max. power	Size
Single Color	50mm	24V	0.4A	9.6W/m	10.6/m	5000x12x17mm 10000x12x17mm
RGB	83mm	24V	0.5A	12W/m	13.2W/m	5000x12x17mm
Bend radius	>60mm					



Photo-electric Parameters

	CRI	CCT	LM/m	LM/W
		2700 K	410	43
		4000 K	420	44
RGB	/	RGB	/	/



NMS1217A-25



NMT1217A

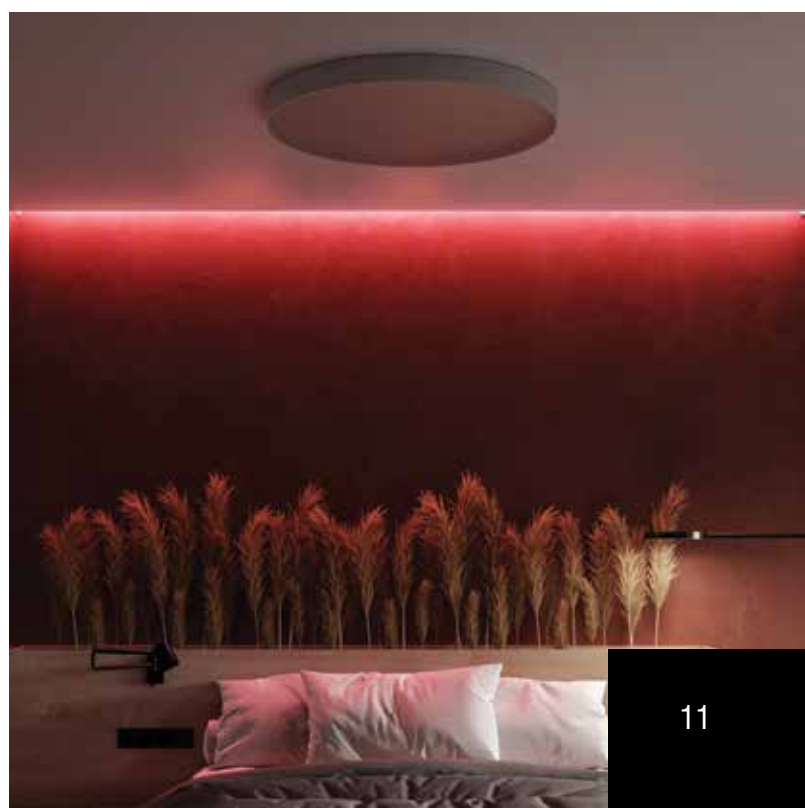

NNR25



NNR25-9SW24NDN050BC0500-ESD 2700K 5m

Fleksibilno, dimabilno, vodootporno IP65, svjetlo 360st, može se rezati bilo gdje (svakih 12mm)



NNR25-9NW24NDN050BC0500-ESD 4000K 5m

Fleksibilno, dimabilno, vodootporno IP65, svjetlo 360st, može se rezati bilo gdje (svakih 12mm)

NNR25 hidden ceiling clip accessories AS-NNR25DCX-XX

NNR25 End cap set (1end+1plug) AS-NNR25GH0-EC

NNR25 Vertical ceiling accessories AS-NNR25VCC1-XX-2

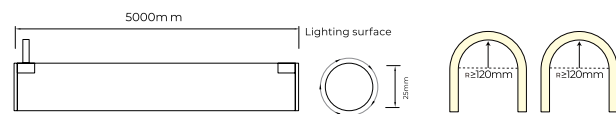

NNR25-9SW24NDN050BC0500-ESD 2700K 5m

NNR25-9NW24NDN050BC0500-ESD 4000K 5m

Basic Parameters

Series	Cutting unit	Input voltage	Input current	Typ. power	Size
White Light	11.9mm	DC24V	0.6A	14.4W	5M
Bend radius	>120mm				

Photo-electric Parameters

Input voltage	CRI	CCT	LM/m	LM/W
		2700 K	950	66
		4000 K	950	66

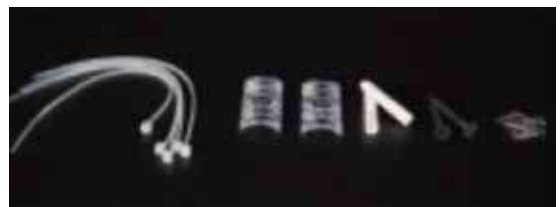

NNR25 hidden ceiling clip accessories AS-NNR25DCX-XX



NNR25 Vertical ceiling accessories AS-NNR25VCC1-XX-2



NNR25 End cap set (1end+1plug) AS-NNR25GH0-EC

RF MODEL DIMMER N12 1x11A 5-24V

Functions	
Brightness Level	11 Levels
Gentle Fading	Yes
Power Off memory	Yes
Power & LED Connector	
Power Connector	Slot screw terminal, max 17AWG each slot, two positive and two negative in parallel.
LED Connector	
Dimension & Weight	
Dimension	Main unit: 87x24x15mm, Remote: 86.5x36x7.5mm
Net Weight	38g



RF MODEL N12 1x11A 5-24V

RF MODEL RGBW N40-S 3x3,5A+6A 5-24V



RF MODEL RGBW N40-S 3x3,5A+6A 5-24V

Functions	
White Control	Independent, 10 Levels brightness
RGB Dynamic Mode	43 modes
Dynamic Speed Level	10 Levels
Static Color	30 colors
Color Brightness Level	5 Levels
Gentle Fading	Yes
Power Off memory	Yes
Power & LED Connector	
Power Connector	Slot screw terminal, max 17AWG each slot, two positive and two negative in parallel.
LED Connector	
Dimension & Weight	
Dimension	Main unit: 87x24x15mm, Remote: 86.5x36x7.5mm
Net Weight	39g



LC-2839 RGB SET

SR-2839 48x120x17.6mm 4.5VDC, 434MHz/868MHz

SR-1029 46X145X16mm 12-24VDC, 3CH, 5A/CH, 180-360W, CONSTANT VOLTAGE



SR-2839



SR-1029

FUT WIRELESS TOUCH RGB REMOTE CONTROL DC 12

- 8 grades brightness adjusting, to achieve real energy-saving
- Use RF signal for telecontroller, free and easy operation, no direction in 20 meters
- Wide options of over 640 000 colors, adjust to your needs
- Long life, lifespan up to 40 000 hours
- Low energy consumption
- With auto & manual color change mode
- No UV radiation, no stroboflash
- Accord with European Union

Specifications:

- Working voltage: 12-24VDC
- Max load power: 3x6A
- Working frequency: 433MHz (20m)
- Dimension: 114x56x22mm/150g
- Battery: 3xAAA 1.5V

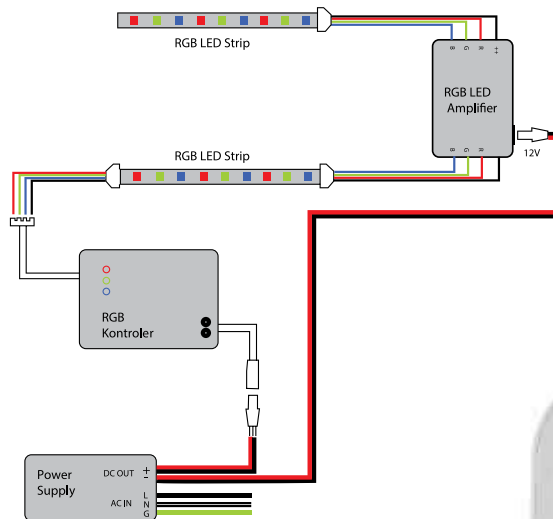

FUT WIRELESS TOUCH RGB REMOTE CONTROL DC 12

RF RGBW CONTROLLER (10 ZONES)

MODEL: LC-2806 WITH LC-1003 SERIES

RGB/RGBW KONTROLER, DO 10 ZONA UPRAVLJANJA



RF RGBW CONTROLLER (10 ZONES)



LC-1003 RCW, 4x5A, 12-36VAC



LC-1003 RCWEA, 4x8A, 12-36VAC

RGBW RECEIVER

MODEL: LC-1003 RCW 4x5A, 12-36VAC

MODEL: LC-1003 RCWEA 4x8A, 12-36VAC



RF WIRELESS RGBW LED CONTROLLER

MODEL: LC-2858 Z8

RGB/RGBW KONTROLER, DO 8 ZONA UPRAVLJANJA



RF WIRELESS RGBW LED CONTROLLER

RF WIRELESS LED REMOTE CONTROLLER

MODEL: LC-2819 WITH LC-1009Fxx RGB/RGBW KONTROLER, DO 6 ZONA UPRAVLJANJA

MODEL: LC-2819S WITH LC-1009Fxx RGB/RGBW KONTROLER, DO 4 ZONE UPRAVLJANJA

MODEL: LC-2818 WITH LC-1009Fxx RGB/RGBW KONTROLER, DO 8 ZONA UPRAVLJANJA

MODEL: LC-2819S-DIM WITH LC-1009Fxx SINGLE COLOR DIMMER KONTROLER, DO 4 ZONE UPRAVLJANJA

MODEL: LC-2819S-CCT WITH LC-1009Fxx SINGLE COLOR CCT KONTROLER, DO 4 ZONE UPRAVLJANJA



LC-2819 WITH LC-1009Fxx



LC-2818 WITH LC-1009Fxx



LC-2819S WITH LC-1009Fxx



LC-2819S-DIM WITH LC-1009Fxx



LC-2819S-CCT WITH LC-1009Fxx

RF SINGLE COLOR CONTROLLER

MODEL: LC-2833S



LC-2833S

RF SINGLE COLOR REMOTE CONTROLLER

MODEL: LC-2833K5



LC-2833K5

RF WIRELESS SINGLE COLOR

MODEL: LC-1009MS-MONO



LC-1009MS-MONO

RF WIRELESS RGBW

MODEL: LC-1009MS-RGBW



LC-1009MS-RGBW

RF RECEIVER LC-1009

MODEL: LC-1009FA 4x5A 12-36VAC

MODEL: LC-1009EA 4x8A 12-36VAC

MODEL: LC-1009CS 1x8A 12-36VAC



LC-1009FA



LC-1009EA



LC-1009CS

RF RECEIVER LC-1009PD-PUSH

MODEL: LC-1009PD-PUSH 4x5A 12-48VDC

*PUSH DIMM, RECEIVER/REPEATER MODE



LC-1009PD-PUSH

RF RECEIVER LC-1009SAC-HP

MODEL: LC-1009SAC-HP 240VAC, 400W, switch&dimmm



LC-1009SAC-HP

RF RECEIVER LC-1009MS

MODEL: LC-1009PDMS 4x5A 12-48VDC

*RF + MANUAL CONTROL, MEMORY FUNCTION



LC-1009MS RECEIVER

LC-2833PAC

MODEL: LC-2833PAC 240VAC, switch&dimmm

*RF PUSH-BUTTON COUPLER, 2 ZONES



LC-2833PAC

RF WIRELESS CCT DIMMER

MODEL: LC-2803B WITH LC 2501M



RF WIRELESS CCT DIMMER

SINGLE ZONE RF WIRELESS DIMMER

MODEL: LC-2828 WITH LC-2501M



SINGLE ZONE RF WIRELESS DIMMER



DIMMER RECEIVER

DIMMER RECEIVER

MODEL: LC-2501M



SINGLE ZONE RF WIRELESS LED DIMMER

MODEL: LC-2828 WITH LC-2501N, NS



SINGLE ZONE RF WIRELESS LED DIMMER



MULTI ZONE RF WIRELESS DIMMER

MULTI ZONE RF WIRELESS DIMMER

MODEL: LC-2801 WITH 2501N, NS



1 ZONES MINI RF SINGLE COLOR LED DIMMER



1 ZONES MINI RF SINGLE COLOR LED DIMMER

MODEL: LC-2807 WITH LC 2501N, NS



LC-2501N



LC-2501NS

DIMMER RECEIVER

MODEL: LC-2501N 4x5A 12-36VDC

MODEL: LC-2501NS 1x8A, 12-36VDC

ONE ZONE DIM REMOTE

MODEL: LC-2833K1

WITH LC-1009



LC-2833K1



LC-2833K2

TWO ZONE DIM REMOTE

MODEL: LC-2833K2

WITH LC-1009



LC-2836R-DIM

LC-2836R-DIM

MODEL: LC-2836R-DIM



LC-2836R-CCT

LC-2836R-CCT

MODEL: LC-2836R-CCT

LC-2836R-RGB

MODEL: LC-2836R-RGB



LC-2836R-RGB

WALL MOUNTED RGBAW DMX512 CONTROLLER

MODEL: LC-2812



LC-2812

WALL MOUNTED RGBAW DMX512 CONTROLLER

MODEL: LC-2811DMX



LC-2811DMX

RF WIRELESS WALL MOUNTED RGBAW CONTROLLER

MODEL: LC-2820 (BLACK&WHITE)



LC-2820 (BLACK&WHITE)



LC-2201

DMX512 MASTER CDW WALL CONTROL PANEL

MODEL: LC-2201



DMX WALL MOUNTED TOUCH PANEL

MODEL: LC-2830-A-DC



LC-2830-A-DC

DMX WALL MOUNTED TOUCH PANEL

MODEL: LC-2830B-DC



LC-2830B-DC



DMX512 DECODER (WITH SMART PUSH MASTER MODE)

MODEL: LC-2108EAS-RJ45 12-36 VDC, 4 CHANNEL / 8A*4, DMX & RDM



LC-2108EAS-RJ45

DMX512 DECODER (WITH STAND-ALONE)

MODEL: LC-2103 FA 12-36 VDC, 4 CHANNEL / 5A*4



LC-2103 FA

RGB/W DMX512 DECODER

MODEL: LC-2104 FA 12-36 VDC, 4 CHANNEL / 5A*4, 4 PUSH BUTTON INPUT



LC-2104 FA

RGB/W DMX512 SWITCH DECODER

MODEL: LC-2703B 100-240 VAC, 5A, 500W



LC-2703B

DALI MASTER LC-2400TL

POGODAN ZA UPRAVLJANJE DIMABILNIM SVJETILJKAMA/ŽARULJAMA



DALI MASTER LC-2400TL

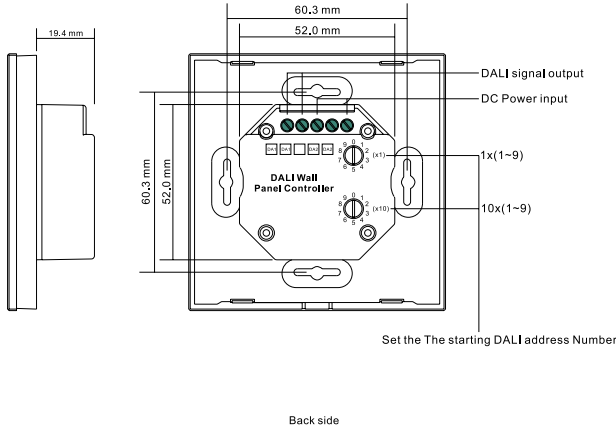

Lamp 1:
Click to recall the first lamp,
Press and hold down to increase/
decrease light intensity Dimming
range from 0.1% to 100%

Lamp 2:
Click to recall the second lamp,
Press and hold down to increase/
decrease light intensity Dimming
range from 0.1% to 100%

Lamp 3:
Click to recall the third lamp
Press and hold down to increase/
decrease light intensity Dimming
range from 0.1% to 100%

Lamp 4:
Click to recall the fourth lamp
Press and hold down to increase/
decrease light intensity Dimming
range from 0.1% to 100%

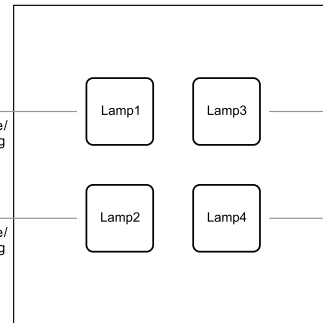

Front side

DALI MASTER LC-2300TS DIM

POGODAN ZA UPRAVLJANJE JEDNOBOJNIM LED TRAKAMA



DALI MASTER LC-2300TS DIM

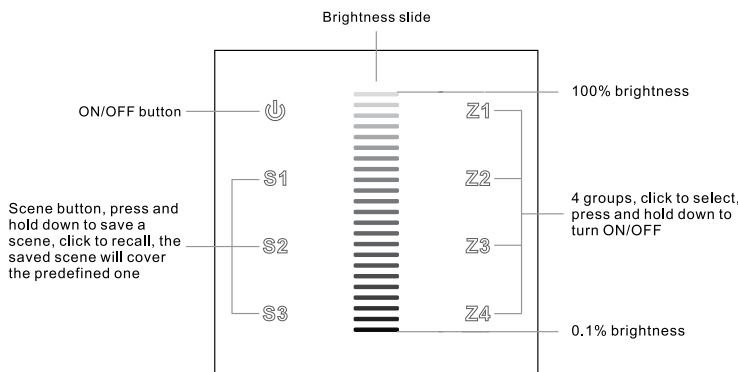

Front side

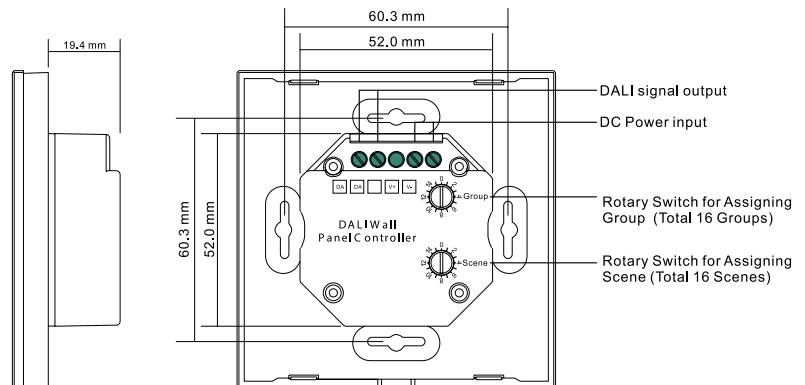

Back side

DALI MASTER LC-2300TS RGB

POGODAN ZA UPRAVLJANJE LED TRAKAMA U BOJI

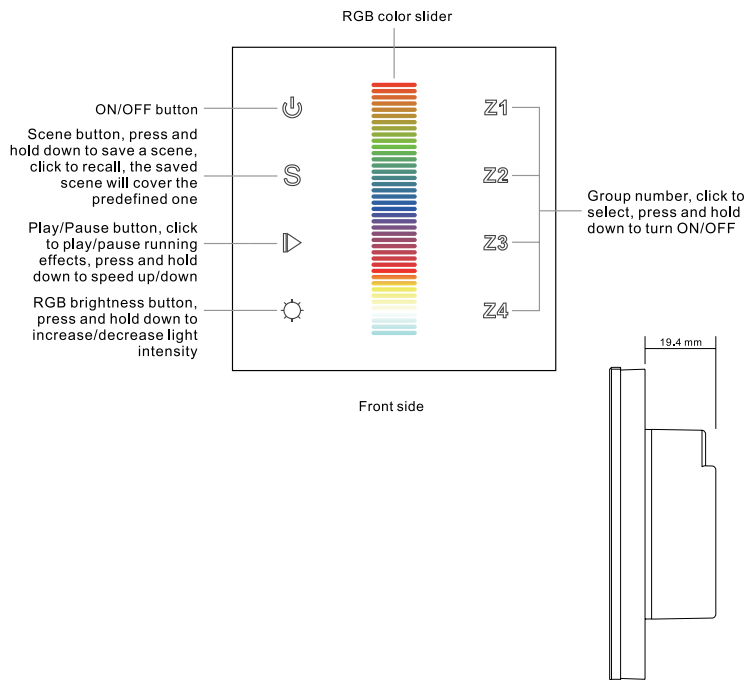

DALI MASTER LC-2300TS RGB

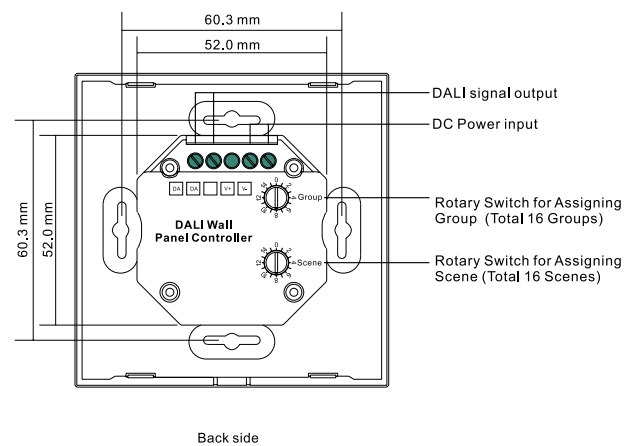

DALI PUSH DIM SWITCH MODULE LC-2400LC

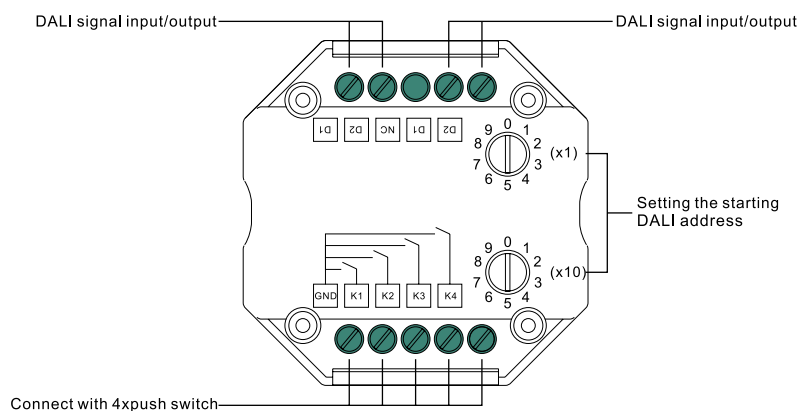
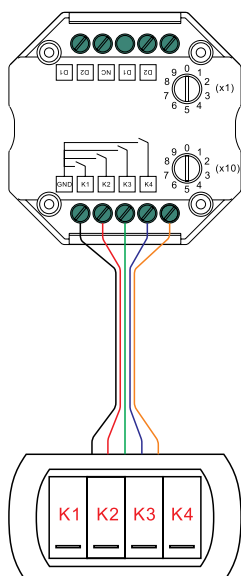

DALI DIMMER (230VAC) LC-2303AC



DALI DIMMER LC-2303AC

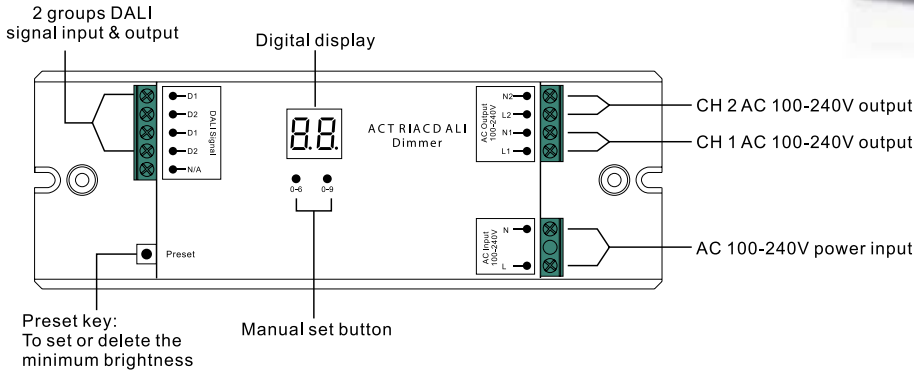

Product Data

Input Voltage	Output Voltage	Output Current	Output Power	Size(LxWxH)
100-240VAC	2x(100-240)VAC	2x1.2A	2x(120-288)W	170x59x29mm

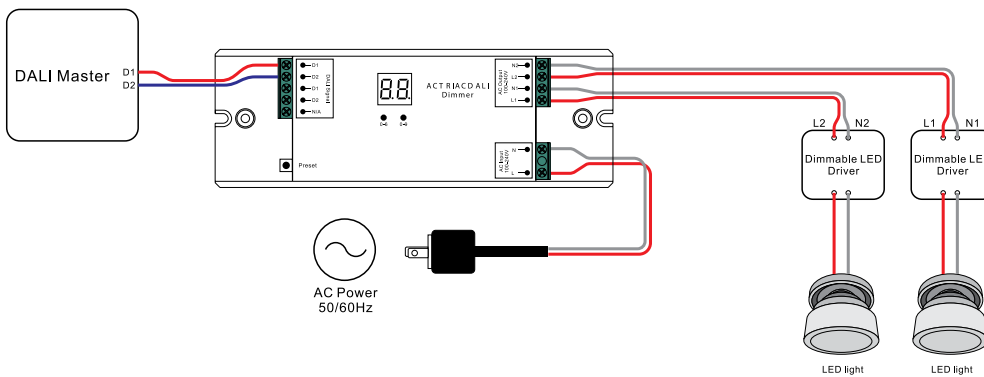

DALI DIMMER (12/24VDC) LC-2302B

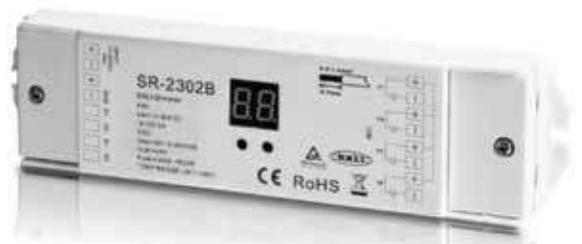

DALI DIMMER LC-2302B

1 DALI ADRESA

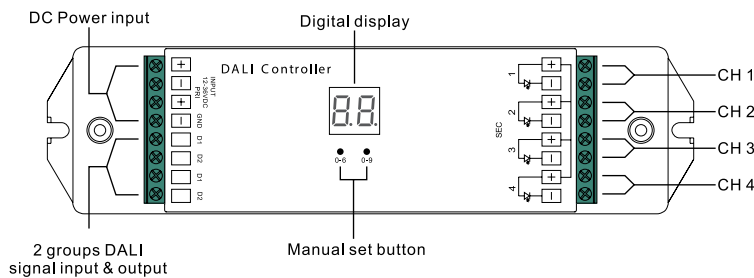

Product Data

No.	Input Voltage	Output Current	Output Power	Remarks	Size(LxWxH)
1	12-36VDC	4x5A	4x(60-180)W	Constant voltage	178x46x22mm

DALI DIMMER (12/24VDC) LC-2303B



DALI DIMMER LC-2303B

4 DALI ADRESE

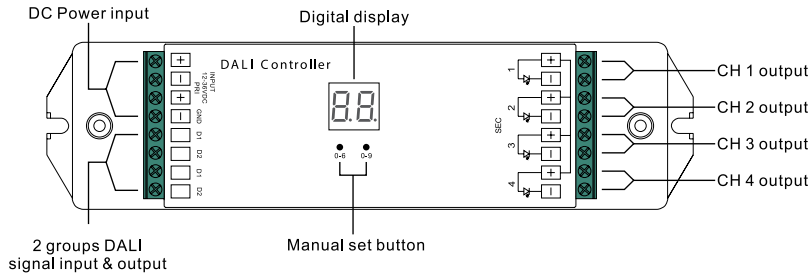

Product Data

No.	Input Voltage	Output Current	Output Power	Remarks	Size(LxWxH)
1	12-36VDC	4x5A	4x(60-180)W	Constant voltage	178x46x22mm

DALI DIMMER (12/24VDC) LC-2304B



DALI DIMMER LC-2304B

PUSH DIM OPTION

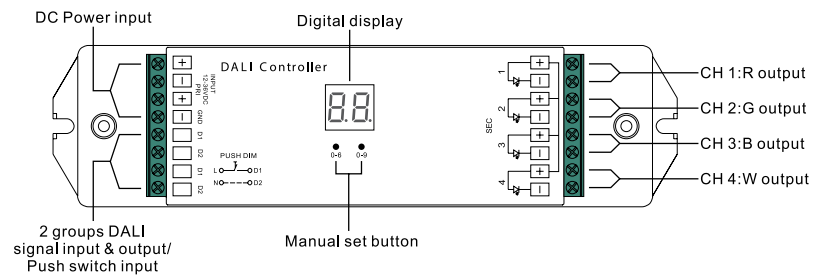

Product Data

No.	Input Voltage	Output Current	Output Power	Remarks	Size(LxWxH)
1	12-36VDC	4x5A	4x(60-180)W	Constant voltage	178x46x22mm

DALI DIMMER (350mA) LC-2316B



DALI DIMMER LC-2316B

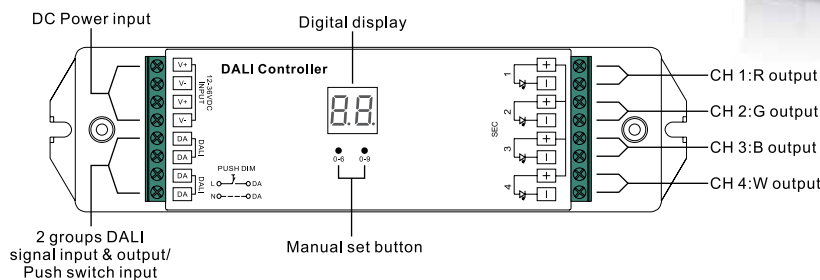

Product Data

No.	Input Voltage	Output Current	Output Power	Remarks	Size(LxWxH)
1	12-36VDC	4x5A	4x(60-180)W	Constant voltage	178x46x22mm

DALI BUS POWER SUPPLY

DLP-04R



DLP-04L



Description

The DALI Power Supply DLP-04 is a power supply with high efficiency and a small size, supplying 240mA for DALI control gears and DALI devices which without power supply circuits. The $-20\sim+60^{\circ}\text{C}$ wide temperature operating range can meet all kinds of applications.

It is perfectly suitable for power up any products labeled with the DALI trademark. With over 35 years of industrial power supply experience, DLP-04 is engineered to be a reliable and safe solution for DALI bus environment.

SPECIFICATION

MODEL		DLP-04R	DLP-04L	
OUTPUT	RATED DC VOLTAGE	16V		
	DC VOLTAGE RANGE	15.3~18.7V		
	RATED CURRENT	240mA		
	GUARANTEED SUPPLY CURRENT	240mA		
	MAXIMUM SUPPLY CURRENT	250mA		
	RATED POWER	3.84W		
	RIPPLE & NOISE (max.) ^{Note.2}	50mVp-p		
	SETUP, RISE TIME	250ms, 50ms/115VAC, 230VAC		
	HOLD UP TIME (Typ.)	70ms/230VAC	16ms/115VAC at full load	
INPUT	VOLTAGE RANGE	90 ~ 264VAC	120 ~ 370VDC	
	FREQUENCY RANGE	47 ~ 63Hz		
	AC CURRENT (Typ.)	0.1A/115VAC	0.06A/230VAC; Model label: 0.4A/100-240VAC	
	INRUSH CURRENT (Typ.)	COLD START 20A/230VAC		
	LEAKAGE CURRENT	0.5mA / 240VAC		
	NO LOAD POWER CONSUMPTION	Typ. 0.5W		<0.5W

REPEATERS/AMPLIFIERS

MODEL: LC-3001, LC-3002

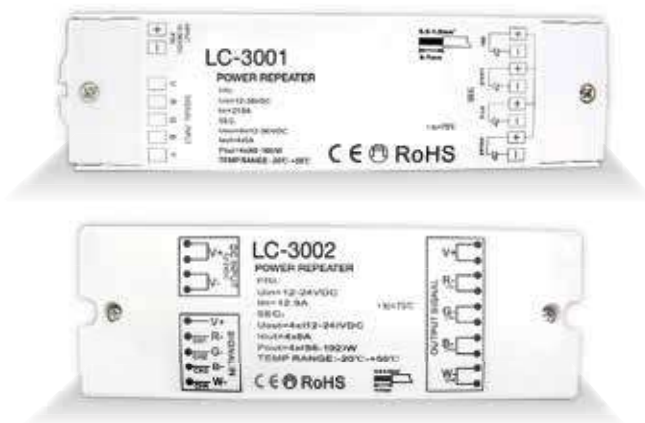

SENSOR SWITCH

MODEL: LC-8001A FOR HAND WAVE

LC-8001B FOR CABINET 230VAC ON/OFF



SENSOR SWITCH

MODEL: LC-8001B- SH, LC-8001A-SH 12/24VDC
WITH: LC 2901



LC-SH-DRIVER

MODEL: LC-2901
FOR: 8001B-SH, 8001 A-SH



PIR MOTION SENSOR SWITCH LC-8004

LC-8004	370X950X200mm	100-240VAC, 5A, 500W, DETECT HUMAN MOVEMENT TO TURN ON/OFF
LC-8004-DC	370X950X200mm	12-36VDC, 1x8A, 1x(96-288)W, DETECT HUMAN MOVEMENT TO TURN ON/OFF



LED TOUCH SENSOR DIMMER LC-2004

LC-2004	370X950X200mm	12-36VDC, 1x8A, 1x(96-288)W, CONSTANT VOLTAGE, DIM & SWITCH
LC-2004B	370X950X200mm	12-36VDC, 1x8A, 1x(96-288)W, CONSTANT VOLTAGE, ONLY SWITCH



PCBA MINI DIMMER

MODEL: LC-2901S 12-24VDC, 3A



LC-ZG-9101SAC-HP

LC-ZG-9101SAC-HP ZIGBEE TRIAC DIMMER 230VAC

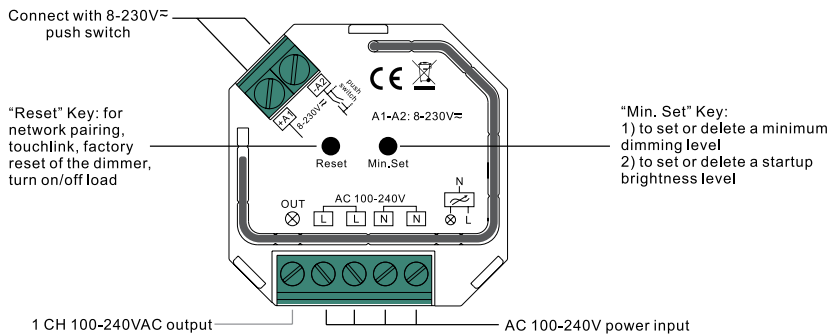

LC-ZG-9101SAC-HP

Product Data

Input Voltage	Output Voltage	Output Current	Size(LxWxH)
100-240VAC	100-240VAC	1.8A max	45.5x45x20.3mm

LC-ZG-9101SAC-HP-switch

LC-ZG-9101SAC-HP ZIGBEE SWITCH 230VAC

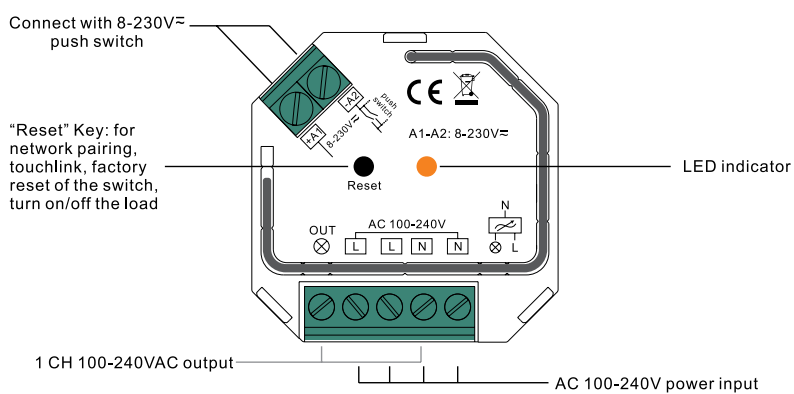

LC-ZG-9101SAC-HP-switch

Product Data

Input Voltage	Output Voltage	Output Current	Size(LxWxH)
100-240VAC	100-240VAC	1.5A max	45.5x45x20.3mm

LC-ZG-9101FA-DIM

LC-ZG-9101FA-DIM ZIGBEE MONO DIMMER 12/24VDC 4x5A



LC-ZG-9101FA-DIM

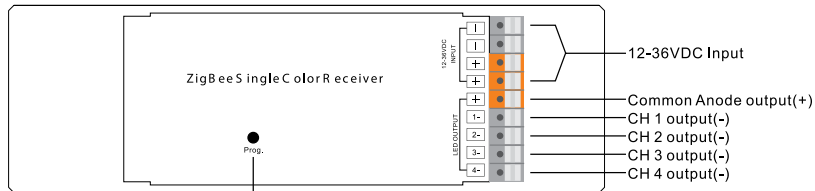

Program Key: short press to switch on/off the device, press and hold down to increase/decrease light intensity

Product Data

No.	Input Voltage	Output Current	Output Power	Output Type	Dimension (LxWxH)
1	12-36VDC	4CH, 5A/CH	240-720W	Constant voltage	170x53.4x28mm

LC-ZG-9101FA-RGBW

LC-ZG-9101FA-RGBW ZIGBEE RGBW DIMMER 12/24VDC 4x5A



LC-ZG-9101FA-RGBW

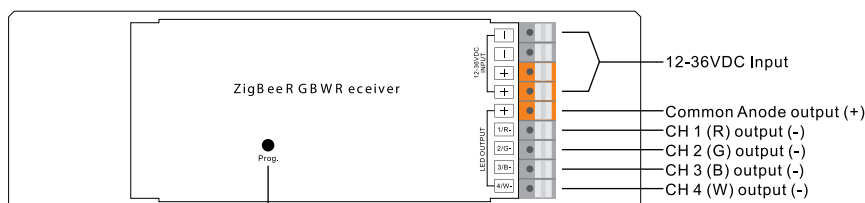

Program Key: short press to switch on/off load, press and hold down to increase/decrease light intensity

Note: W channel can only be controlled through color temperature control command since Zigbee only has tunable white control. Color temperature control will mix RGB channels as 1 channel white and then make color tuning with the 4th channel white.

Product Data

No.	Input Voltage	Output Current	Output Power	Output Type	Dimension (LxWxH)
1	12-36VDC	4CH, 5A/CH	240-720W	Constant voltage	170x53.4x28mm

LC-ZG-9101CS

LC-ZG-9101CS ZIGBEE MONO DIMMER 12/24VDC 8A



LC-ZG-9101CS

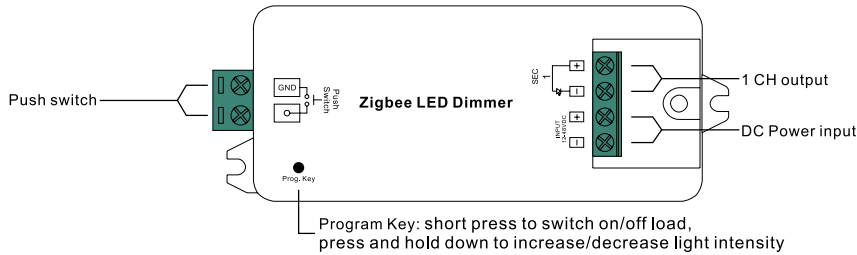

LC-ZG2868

LC-ZG2868 ZIGBEE REMOTE RGB 4 ZONE

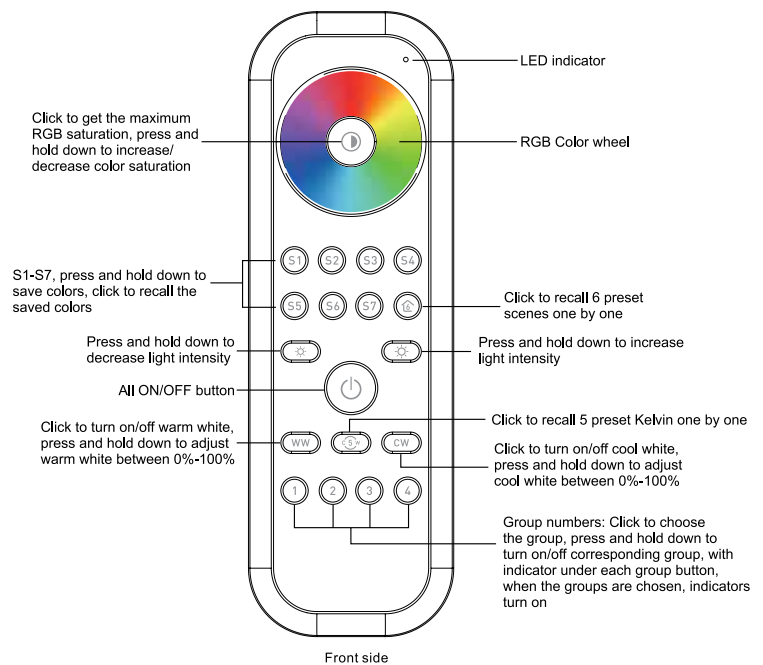

LC-ZG-2868

Product Data

Protocol	ZigBee 3.0
Operation Voltage	6V(2*CR2032 battery)
Transmission Frequency	2.4GHz
Transmission Range (free field)	30m
Dimming Range	0.1%-100%
Dimension	137x45x13mm
Protection Grade	IP20

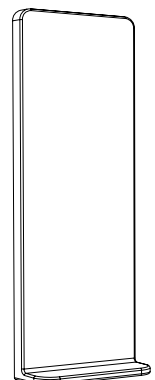

Magnetic Bracket

- ZigBee RGB+CCT+DIM remote based on ZigBee 3.0
- High sensitive & high stable touch color wheel, fast & precise color control
- Battery powered remote with low power consumption
- Enables to pair ZigBee lighting devices through touchlink commissioning
- Supports find and bind mode to pair with ZigBee lighting devices
- Supports 4 groups for binding max. 30 lighting devices
- With 6 preset scenes, 5 preset Kelvin, enables to save and recall 7 scenes
- Enables to adjust RGB color saturation
- 2.4 GHz global operation
- Transmission range up to 30m
- Compatible with universal ZigBee Gateway products
- Enables to bind and control universal DIM, CCT, RGB, RGBW and RGB+CCT zigbee lighting devices

LC-ZG-9001K12-DIM-Z5

LC-ZG-9001K12-DIM-Z5 ZIGBEE REMOTE DIMMER 5 ZONE



LC-ZG-9001K12-DIM-Z5

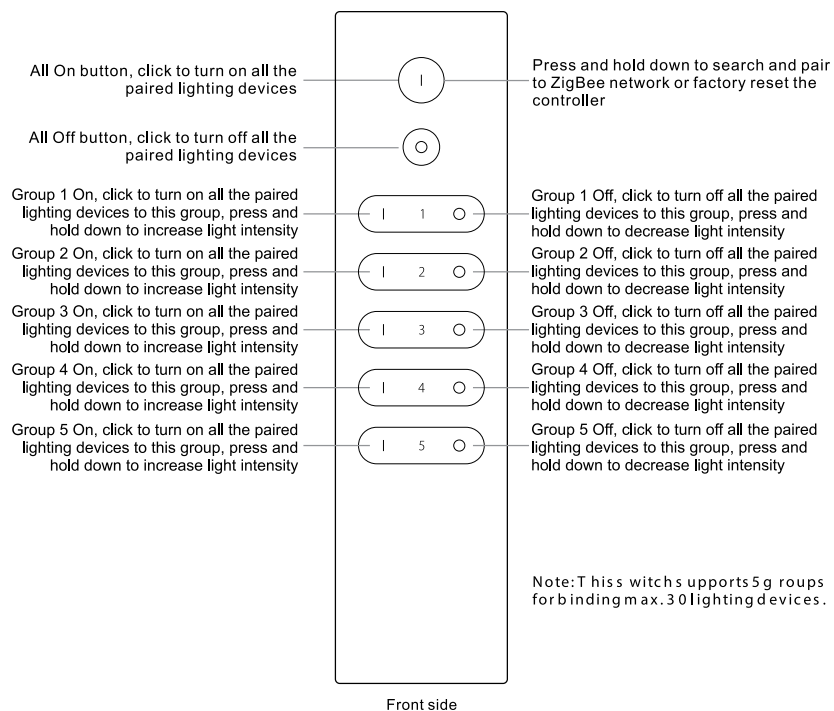

LC-2818WIN-ZG

LC-2818WIN-ZG ZIGBEE GATEWAY



LC-2818WIN-ZG

LC-ZG9011A-DS

LC-ZG9011A-DS ZIGBEE SENZOR ZA VRATA



LC-ZG9011A-DS

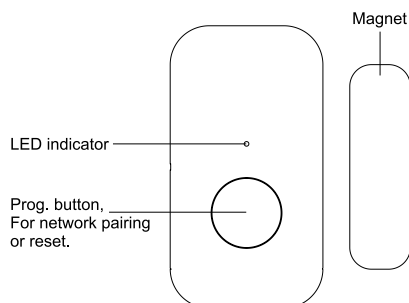

Product Data

Radio Frequency	2.4GHz
Power Supply	3VDC (CR2032 Batteries)
Operating temperature	0 to 40°C
Relative humidity	8% to 80%
Dimensions	Transmitter: 49x26.5x10mm, Magnet: 35.5x10.5x10mm



XTE50W (5 in 1)

XTE50W DC 6-24V, 5x8A (total max 24A), Tuya wifi, Umi protocol based on BLE mesh, press-key control, Single color, CCT, RGB, RGBW, RGB CCT

Wiring

Please connect the controller output to LED loads and power supply to the controller power input. The power supply voltage must be same as the LED load's rated voltage. Check all cables to be well connected and insulated before power on.

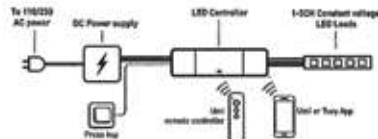

The controller supports 1-5 channel application from single color to RGB+CCT, please refer to following diagram for multiple application output wiring.

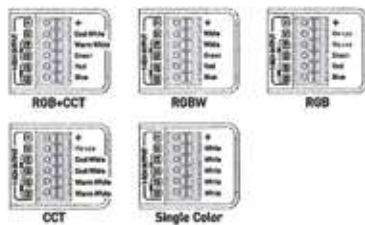

XTE50W

BR03-CG

BR03-CG On/off, dimming, color tuning and group/scene (For multi color), DC3V, CR2032 cell battery, SIG BLE mesh protocol, 2.4GHz ISM band



XTE50W

Umi Smart Wireless LED Remote Controller
Model: BR03-CG
For Multi-Channel Dimming / Color Scene / Group

Function

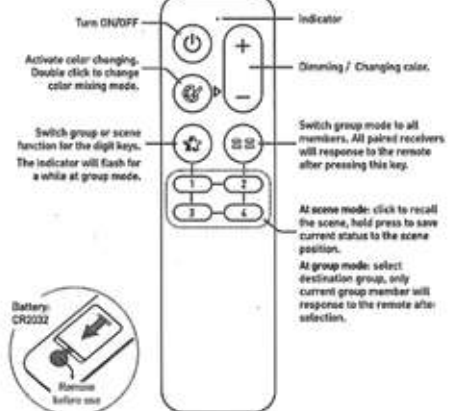

LED DRIVER SLC 12V

SLC-15-12 OUTPUT 15W-12V, INPUT 180-265VAC, IP20

▪ **Dimension:** 115x40x25mm

SLC-25-12 OUTPUT 25W-12V, INPUT 180-265VAC, IP20

▪ **Dimension:** 115x40x25mm

SLC-36-12 OUTPUT 36W-12V, INPUT 180-265VAC, IP20

▪ **Dimension:** 115x40x25mm

SLC-60-12 OUTPUT 60W-12V, INPUT 180-265VAC, IP20

▪ **Dimension:** 130x50x32mm

SLC-100-12 OUTPUT 100W-12V, INPUT 180-265VAC, IP20

▪ **Dimension:** 190x50x32mm

SLC-150-12 OUTPUT 150W-12V, INPUT 180-265VAC, IP20

▪ **Dimension:** 200x62x32mm

SLC-200-12 OUTPUT 200W-12V, INPUT 180-265VAC, IP20

▪ **Dimension:** 210x80x30mm

SLC-250-12 OUTPUT 250W-12V, INPUT 180-265VAC, IP20

▪ **Dimension:** 210x80x30mm

SLC-350-12 OUTPUT 350W-12V, INPUT 180-265VAC, IP20

▪ **Dimension:** 210x80x30mm



SLC-15-12



SLC-25-12



SLC-36-12



SLC-60-12



SLC-100-12



SLC-150-12



SLC-200-12



SLC-250-12



SLC-350-12

CE RoHS COMPLIANT (warranty 5 years) ERP2.0

LED DRIVER SLC 24V

SLC-25-24 OUTPUT 25W-24V, INPUT 180-265VAC, IP20

▪ **Dimension:** 115x40x25mm

SLC-36-24 OUTPUT 36W-24V, INPUT 180-265VAC, IP20

▪ **Dimension:** 115x40x25mm

SLC-60-24 OUTPUT 60W-24V, INPUT 180-265VAC, IP20

▪ **Dimension:** 130x50x32mm

SLC-100-24 OUTPUT 100W-24V, INPUT 180-265VAC, IP20

▪ **Dimension:** 190x50x32mm

SLC-150-24 OUTPUT 150W-24V, INPUT 180-265VAC, IP20

▪ **Dimension:** 200x62x32mm

SLC-200-24 OUTPUT 200W-24V, INPUT 180-265VAC, IP20

▪ **Dimension:** 210x80x30mm

SLC-350-24 OUTPUT 350W-24V, INPUT 180-265VAC, IP20

▪ **Dimension:** 210x80x30mm

CE RoHS COMPLIANT (warranty 5 years) ERP2.0



SLC-15-24



SLC-25-24



SLC-36-24



SLC-60-24



SLC-100-24



SLC-150-24



SLC-200-24



SLC-350-24

LED DRIVER WPS 12V IP66

WPS-15-12 OUTPUT 15W-12V, INPUT 180-265VAC, IP66

- **Dimension:** 190x20x20mm

WPS-30-12 OUTPUT 30W-12V, INPUT 180-265VAC, IP66

- **Dimension:** 280x20x20mm

WPS-45-12 OUTPUT 45W-12V, INPUT 180-265VAC, IP66

- **Dimension:** 310x20x20mm

WPS-60-12 OUTPUT 60W-12V, INPUT 180-265VAC, IP66

- **Dimension:** 160x50x32mm

WPS-100-12 OUTPUT 100W-12V, INPUT 180-265VAC, IP66

- **Dimension:** 220x50x32mm

WPS-150-12 OUTPUT 150W-12V, INPUT 180-265VAC, IP66

- **Dimension:** 230x65x32mm

WPS-200-12 OUTPUT 200W-12V, INPUT 180-265VAC, IP66

- **Dimension:** 280x80x32mm



WPS-15-12



WPS-30-12

CE RoHS COMPLIANT (warranty 5 years) ERP2.0



WPS-45-12



WPS-60-12



WPS-100-12



WPS-150-12



WPS-200-12

LED DRIVER WPS 24V IP66



WPS-30-24

WPS-30-24 OUTPUT 30W-24V, INPUT 180-265VAC, IP66

- **Dimension:** 280x20x20mm

WPS-60-24 OUTPUT 60W-24V, INPUT 180-265VAC, IP66

- **Dimension:** 160x50x32mm

WPS-100-24 OUTPUT 100W-24V, INPUT 180-265VAC, IP66

- **Dimension:** 220x50x32mm

WPS-150-24 OUTPUT 150W-24V, INPUT 180-265VAC, IP66

- **Dimension:** 230x65x32mm

WPS-200-24 OUTPUT 200W-24V, INPUT 180-265VAC, IP66

- **Dimension:** 280x80x32mm







WPS-60-24

LED DRIVER 12V IP66

WPS-15-12-R 220/240VAC, 12V, 15W, IP66

- **Dimension:** Ø50x22mm



WPS-100-24



LED DRIVER 12V IP66



WPS-150-24



WPS-200-24

MW NAPA JANJA 12V/24V IP20



LRS-25	78x51x28mm	IP20, 12V, 25W	LRS-25	78x51x28mm	IP20, 24V, 25W
LRS-35	99x82x36mm	IP20, 12V, 35W	LRS-35	99x82x36mm	IP20, 24V, 35W
LRS-50	99x97x36mm	IP20, 12V, 50W	LRS-50	99x97x36mm	IP20, 24V, 50W
LRS-75	129x97x38mm	IP20, 12V, 75W	LRS-75	129x97x38mm	IP20, 24V, 75W
LRS-100	159x97x38mm	IP20, 12V, 100W	LRS-100	159x97x38mm	IP20, 24V, 100W
LRS-150	199x98x42mm	IP20, 12V, 150W	LRS-150	199x98x42mm	IP20, 24V, 150W
RSP-200	215x115x30mm	IP20, 12V, 200W	RSP-200	215x115x30mm	IP20, 24V, 200W



MW NAPA JANJA 12V/24V IP20



RSP-320	215x115x60mm	IP20, 12V, 320W
RSP-320	215x115x60mm	IP20, 24V, 320W



ERPF NAPA JANJA 12V/24V IP20



ERPF 400	200x130x45mm	IP20, 12V, 400W
ERPF 400	200x130x45mm	IP20, 24V, 400W



MW VODOOTPORNA NAPAJANJA 12V/24V IP67



LPV-20	118x35x26mm	IP67, 12V, 20W	LPV-20	118x35x26mm	IP67, 24V, 25W
LPV-35	148x40x30mm	IP67, 12V, 35W	LPV-35	148x40x30mm	IP67, 24V, 35W
LPV-60	162,5x42,5x32mm	IP67, 12V, 60W	LPV-60	162,5x42,5x32mm	IP67, 24V, 60W
LPV-100	190x52x37mm	IP67, 12V, 100W	LPV-100	190x52x37mm	IP67, 24V, 100W
LPV-150	191x63x37,5mm	IP67, 12V, 150W	LPV-150	191x63x37,5mm	IP67, 24V, 150W



YSL80-4500950D

DIMMABLE DRIVER ZA P1 PANELE 40W



YSL30T-1202500

Constant Voltage Input: 230VAC 50Hz, Output:12V 30W max. DC 2.5A, Input and Output: Terminal Block, Short Circuit, over current, over voltage protection

• **Dimension:** 251*30*16mm



YSL30T-1202500



YSL30T-1205000

YSL60T-1205000

Constant Voltage Input: 230VAC 50Hz, Output:12V 60W max. DC 5A, Input and Output: Terminal Block, Short Circuit, over current, over voltage protection

• **Dimension:** 320*30*19mm

YSL100T-1208300

Constant Voltage Input: 230VAC 50Hz, Output:12V 100W max. DC 8.3A, Input and Output: Terminal Block, Short Circuit, over current, over voltage protection



YSL100T-1208300

• **Dimension:** 320*30*19mm

ALP001-ALS-BE2507

ALP001-ALS-BE2507 PROFIL UGRADNI

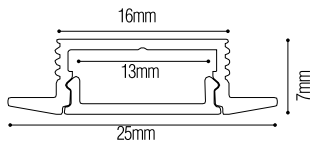

Profile Components

Profile	L2000×W25×H7mm	
Diffuser	L2000×W14.49×H3.5mm	
Holeless end caps	EC-BE2507 L25×W7×H11.5mm	
End cap with hole	EC-BE2507 L25×W7×H11.5mm	



ALP002-ALS-BS1607

ALP002-ALS-BS1607 PROFIL NADGRADNI

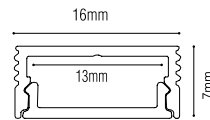

Profile Components

Profile	L2000 × W16 × H7mm	
Diffuser	L2000 × W14.49 × H3.5mm	
Holeless end caps	EC-BS1607 L16 × W7 × H7.5mm	
End cap with hole	EC-BS1607 L16 × W7 × H7.5mm	

Installation Accessories

Mounting clip	CP-04 17.8 × 15 × 4.5mm	
---------------	----------------------------	---



ALP003-ALS-BE2513

ALP003-ALS-BE2513 PROFIL UGRADNI

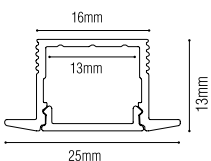

Profile Components

Profile	L2000×W25×H13mm	
Diffuser	L2000×W14.49×H3.5mm	
Holeless end caps	EC-BE2513 L25×W13×H11.5mm	
End cap with hole	EC-BE2513 L25×W13×H11.5mm	



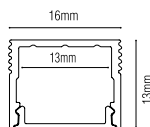

ALP004-ALS-BS1613

ALP004-ALS-BS1613 PROFIL NADGRADNI



Profile Components

Profile L2000 × W16 × H13mm 

Diffuser L2000 × W14.49 × H3.5mm 

Holeless end caps EC-BS1613
L16 × W13 × H7.5mm 

End cap with hole EC-BS1613
L16 × W13 × H7.5mm 

Installation Accessories

Mounting clip CP-04
17.8 × 15 × 4.5mm 

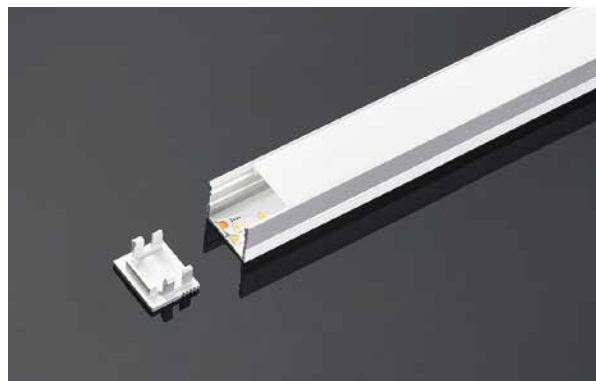

ALP006-ALS-BG1616

ALP006-ALS-BG1616 PROFIL KUTNI

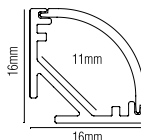

Profile Components

Profile L2000 × W16 × H16mm 

Diffuser L2000 × W19.4 × H6mm 

Holeless end caps EC-BG1616C
L16 × W16 × H7.5mm 

End cap with hole EC-BG1616C
L16 × W16 × H7.5mm 

Installation Accessories

Mounting clip CP-13
L15 × W 17 × H 17mm 



ALP007-ALS-BG1818

ALP007-ALS-BG1818 PROFIL KUTNI

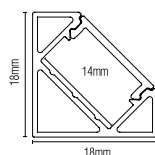

Profile Components

Profile L2000 × W18 × H18mm 

Diffuser L2000 × W14.5 × H3.5mm 

Holeless end caps EC-BG1818
L18 × W18 × H7.2mm 

End cap with hole EC-BG1818
L18 × W18 × H7.2mm 

Installation Accessories

Mounting clip CP-49
L19.5 × W 19.5 × H 14mm 



ALP001

ALUMINIJSKI PROFIL UGRADBENI



PVC ZAVRŠETAK

ALP001 bez rupe
ALP001 sa rupom



ALU PROFIL

LL-ALP001 Aluminijski profil
7mm ugradbeni 2m



POKROV

CLEAR 2m / SEMI CLEAR 2m /
OPAL MAT 2m

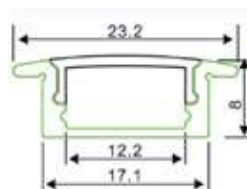

ALP002

ALUMINIJSKI PROFIL NADGRADBENI

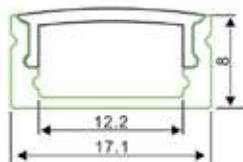

PVC ZAVRŠETAK

ALP002 bez rupe
ALP002 sa rupom



ALU PROFIL

LL-ALP002 Aluminijski profil
7mm ugradbeni 2m



POKROV

CLEAR 2m / SEMI CLEAR 2m /
OPAL MAT 2m



PLOČICA ZA PRIČVRŠČIVANJE

ALP002



LL-ALP002-R BLACK

POKROV CRNI PC 2m



LL-ALP002-R BLACK

ALUMINIJSKI PROFIL CRNI 2m

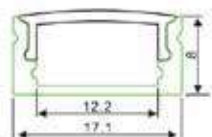

LL-ALP002-R BLACK

POKROV CRNI PC 2m



ALP021

ALUMINIJSKI PROFIL NADGRADBENI



PVC ZAVRŠETAK

ALP021 bez rupe
ALP021 sa rupom



ALU PROFIL

LL-ALP021 Aluminijski profil
8.2mm nadgradbeni 2m



POKROV

CLEAR 2m / SEMI CLEAR 2m /
OPAL MAT 2m



ALP023

ALUMINIJSKI PROFIL UGRADBENI

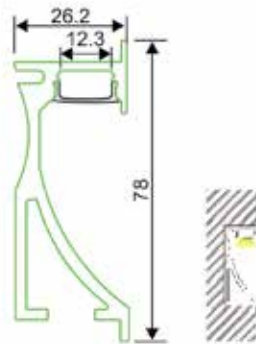

PVC ZAVRŠETAK

ALP023 bez rupe
ALP023 sa rupom



ALU PROFIL

LL-ALP023 Aluminijski profil
ugradbeni zidni 2m



POKROV

CLEAR 2m / SEMI CLEAR 2m /
OPAL MAT 2m



LL-ALP039

ALUMINIJSKI PROFIL KUTNI



PVC ZAVRŠETAK

ALP039 bez rupe
ALP039 sa rupom



METALNI DRŽAČ PROFILA

ALP039



ALP-039 - 30°
CLEAR 2M/PC



ALP-039 - 60°
CLEAR 2M/PC



ALP-039 - COVER
PMMA CLEAR 2M/PC



ALP-039 - COVER
PMMA SEMMI CLEAR
2M/PC



ALP-039 - COVER
PMMA OPAL MATT
2M/PC



LL-ALP028

NADGRADBENA VISILICA

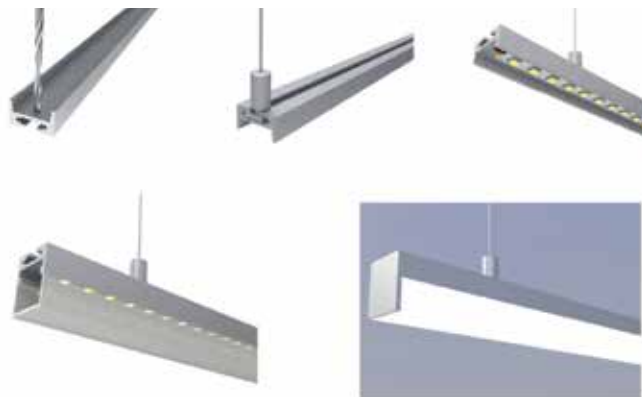
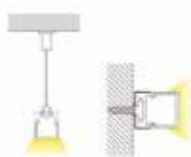
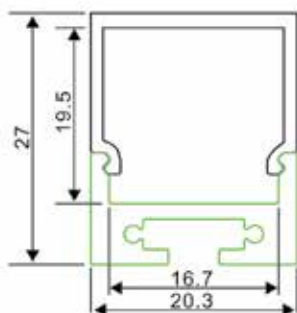
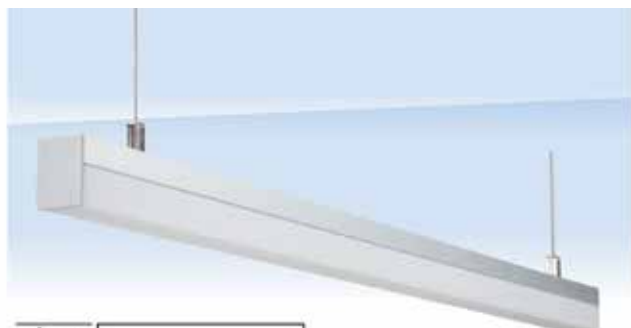

ALU PROFIL

LL-ALP028
Nadgradbena visilica 2m



OVJESNI MEHANIZAM ZA VISILICU

Za profil ALP028



PVC ZAVRŠETAK

ALP028 bez rupe
ALP028 sa rupom



POKROV

ALP028 PMMA
OPAL MAT 2m



LL-ALP033

ALUMINIJSKI PROFILU GRADBENI VODOTIJESNI

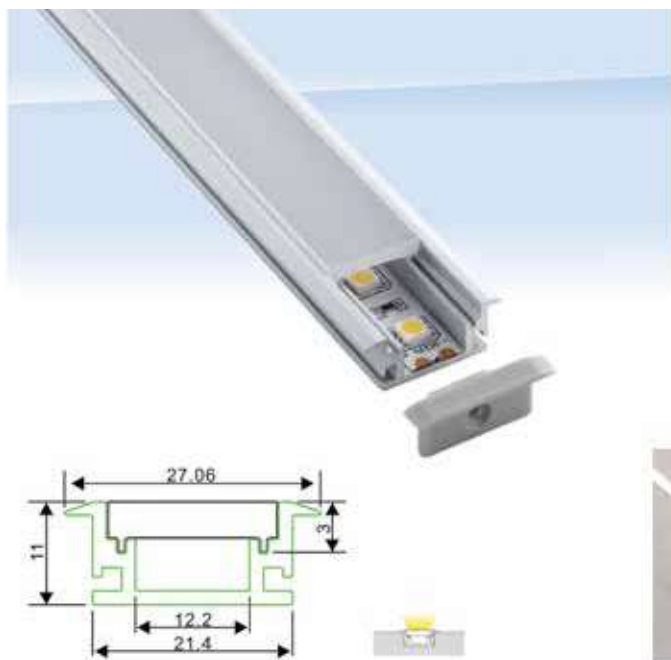

ALU PROFIL

LL-ALP03 Podni ugradbeni vodotijesni 2m



PVC ZAVRŠETAK

ALP033 bez rupe
ALP033 sa rupom



POKROV

ALP033 PC 3mm pojačani 2m



LL-ALP031

ALUMINIJSKI PROFIL UGRADBENI ZIDNI STROPNI

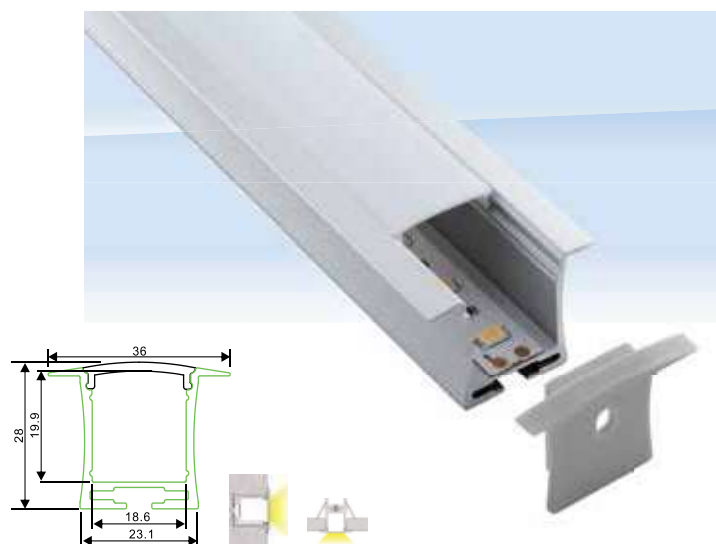

ALU PROFIL

LL-ALP031 UGRADBENI ZIDNI STROPNI 2m



PVC ZAVRŠETAK

ALP031 bez rupe
ALP031 sa rupom



POKROV

ALP031 PMMA SEMI CLEAR 2m



OPRUGA ZA MONTAŽU PROFILA

ALP031



LL-ALP054

VIŠEĆI ALUMINIJSKI PROFIL

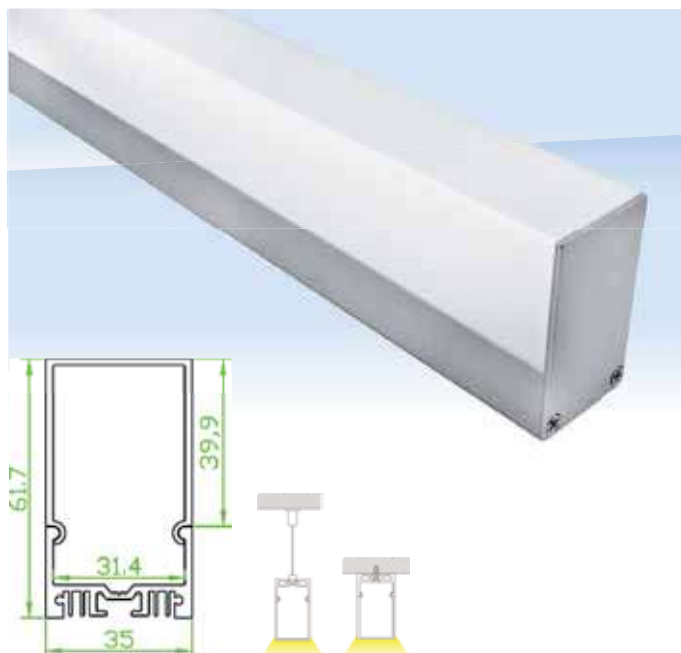

ALU PROFIL



ALU PROFIL

LL-ALP054 Aluminjski profil za vješanje 2m



POKROV

ALP054 PC OPAL-MATT 2m



OVJESNI MEHANIZAM

ALP054 pojačani 2m



LL-ALP050

ALUMINIJSKI PROFIL ZIDNI

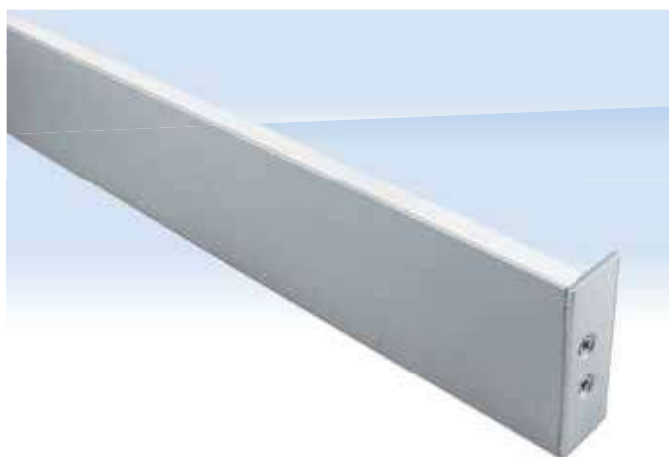

ALU PROFIL

LL-ALP050 ZIDNI 2m



PVC ZAVRŠETAK



POKROV

ALP050 PC SEMI-CLEAR 2m



OPRUGA ZA MONTAŽU PROFILA

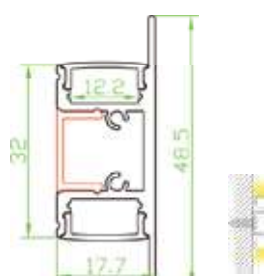

LL-ALP045

ALUMINIJSKI PROFIL ZIDNI

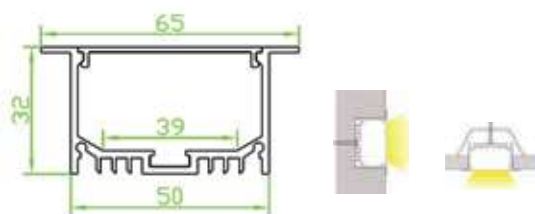

ALU PROFIL

LL-ALP045 ALUMINIJSKI
PROFIL ZIDNI 2m

ZAVRŠETAK



POKROV

ALP045 PC MATT 2m

DRŽAČ PROFILA

ALP045

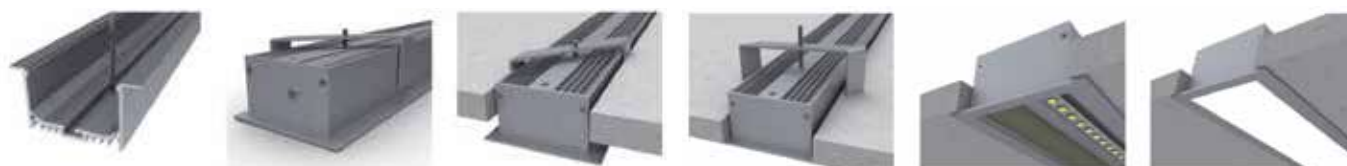

LL-ALP048

ALUMINIJSKI PROFIL VISEĆI

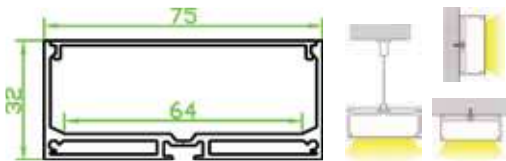

ALU PROFIL

LL-ALP048
Viseći 2m



ZAVRŠETAK



POKROV

ALP048 PC
OPAL MAT 2m



OVJESNI MEHANIZAM ZA VISILICU

ALP048



ALP 114

FLEKSIBILNI ALUMINIJSKI PROFIL

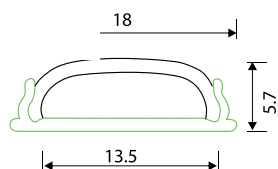

ALU PROFIL

ALP114 Aluminijski profil fleksibilni 2m

POKROV

ALP114
OPAL MAT 2m

ZAVRŠETAK



DRŽAČ PROFILA

METALNI



LL-ALP3875-R

Light Source: 2835MD LED module, double rows

Installation: - Surface Mounting Direct
- Suspended Direct
- Wall Mounting

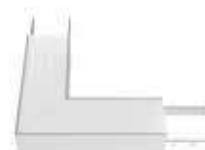
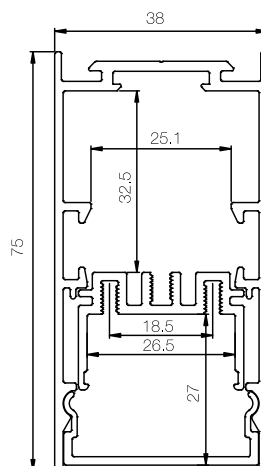
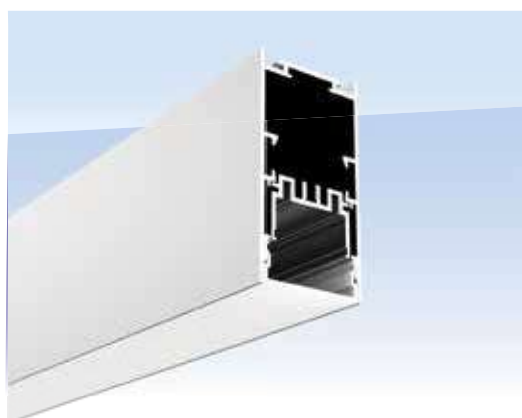
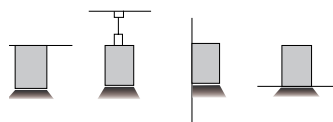

ZAVRŠETAK



DRŽAČ PROFILA
UNUTARNJI



DRŽAČ PROFILA
VANJSKI



OVJESNI MEHANIZAM
ZA VISILICU



MEĐUSPOJNIK
PROFILA

LL-ALP 014

ALUMINIUM PROFILE, 2M/PC

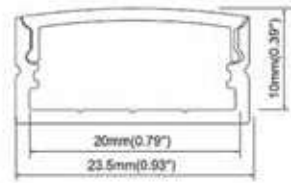

END CAP WITH HOLE
END CAP WITHOUT HOLE

MOUNTING CLIP (METAL)

ALP 013

ALUMINIUM PROFILE, 2M/PC

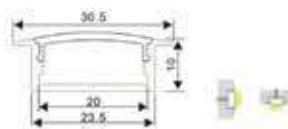

ALUMINIJSKI
PROFIL

POKROV

PVC ZAVRŠETAK
bez rupe
sa rupom



ALP 071

ALUMINIUM PROFILE TRIMLES, 2M/PC

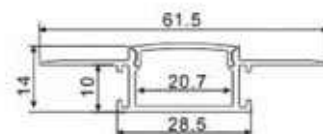

**ALUMINIJSKI
PROFIL**



POKROV
PC opal diffuser cover,
2m/PC



PVC ZAVRŠETAK
bez rupe
sa rupom



POKROV
crni PC 2m

ALP215-RC

Fleksibilni aluminijumski LED profil za ugradnju u gipskartonske ploče(knauf)

ALUMINIUM PROFILE, 2M/PC SAVITLJIV U SVIM SMJEROVIMA

SILICON TUBE DIFFUSER 1m BEZ SPOJVA, DOLAZI U ROLI OD 20M, SAVITLJIV U SVIM SMJEROVIMA

EC215-RC END CAP 2 KOM SET

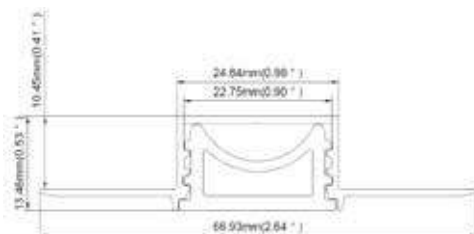

ALP 50C

ALP50C Ø900

ALUMINIUM PROFILE WITH PMMA COVER, FORM A Ø900MM ROUND SHAPE FOR HANGING, LIGHT UP AND DOWN AT THE SAME TIME, BLACK COLOR WITH DIFFUSER/COVER AND ACCESSORIES (IN PARTS, OF 4 PIECES)

ALP50C Ø1270

ALUMINIUM PROFILE WITH PMMA COVER, FORM A Ø1270MM ROUND SHAPE FOR HANGING, LIGHT UP AND DOWN AT THE SAME TIME, BLACK COLOR WITH DIFFUSER/COVER AND ACCESSORIES (IN PARTS, OF 4 PIECES)

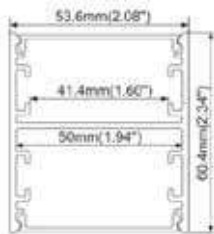

ALP50C Ø900









ALP50C Ø1270



LED MAGNETIC TRACK LIGHT

1	LED-L001-48VDC-6W-400lm-3000K	BLACK	CRI(Ra) 90, BEAM ANGLE 60°, IP20	120*22*95mm	
2	LED-L001-48VDC-6W-400lm-3000K	WHITE	CRI(Ra) 90, BEAM ANGLE 60°, IP20	120*22*95mm	
3	LED-L001-48VDC-12W-800lm-3000K	BLACK	CRI(Ra) 90, BEAM ANGLE 60°, IP20	220*22*95mm	
4	LED-L007-48VDC-12W-800lm-3000K	BLACK	CRI(Ra) 90, BEAM ANGLE 60°, IP20	303*23*47mm	
5	LED-L007-48VDC-18W-1200lm-3000K	BLACK	CRI(Ra) 90, BEAM ANGLE 60°, IP20	603*23*47mm	
6	LED-L007-48VDC-18W-1200lm-3000K	WHITE	CRI(Ra) 90, BEAM ANGLE 60°, IP20	603*23*47mm	
7	LED-S20BL300-48VDC-20W-1100lm-3000K	BLACK	CRI(Ra) 90, BEAM ANGLE 100°, IP20	300+300*23*47mm	



8	LED-L006-48VDC-5W-350lm-3000K	BLACK	CRI(Ra) 90, BEAM ANGLE 60°, IP20	126*30*145mm	
9	LED-L006-48VDC-5W-350lm-3000K	WHITE	CRI(Ra) 90, BEAM ANGLE 60°, IP20	126*30*145mm	
10	LED-C20QD100-48VDC-5W-250lm-3000K	BLACK	CRI(Ra) 90, BEAM ANGLE 360°, IP20	1m cable, Ø100mm	
11	LED-C20S02918A-48VDC-18W-1260lm-3000K	BLACK	CRI(Ra) 90, BEAM ANGLE 100°, IP20	h38*Ø100mm	
12	LED-L002-48VDC-6W-400lm-3000K	BLACK	CRI(Ra) 90, BEAM ANGLE 60°, IP20	300*Ø30mm, cable 1m	
13	LED-L002-48VDC-6W-400lm-3000K	WHITE	CRI(Ra) 90, BEAM ANGLE 60°, IP20	300*Ø30mm, cable 1m	



14	DRIVER-HM09-AC220V-240V-50/60Hz-100W-48VDC	BLACK	output-30cm cable 48V In track driver, 30cm input cable, IP20
	DRIVER-HM09-AC220V-240V-50/60Hz-200W-48VDC	BLACK	output-30cm cable 48V In track driver, 30cm input cable, IP20
15	DRIVER-HM09-AC220V-240V-50/60Hz-100W-48VDC	WHITE	output-30cm cable 48V In track driver, 30cm input cable, IP20
16	HM22-0014-STRAIGHT MIDDLE CONNECTOR	BLACK	
17	HM22-0014-STRAIGHT MIDDLE CONNECTOR	WHITE	
18	HM22-0015-SOFT MIDDLE CONNECTOR	BLACK	
19	HM22-0015-SOFT MIDDLE CONNECTOR	WHITE	
20	HM22-0016-POWER INPUT CONNECTOR 15cm WIRE	BLACK	
21	HM22-0021-INSTALLATION CLIP FOR RECESSED TRACK RAIL, INSTALLATION CLIP FOR CORNER		
22	HM22-0004-1m recessed track rail, with end cap, with overlay	BLACK	
	HM22-0004-2m recessed track rail, with end cap, with overlay	BLACK	
23	HM22-0004-2m recessed track rail, with end cap, with overlay	WHITE	
24	HM22-0012-90° horizontal corner for recessed track rail	BLACK	
25	HM22-0012-90° horizontal corner for recessed track rail	WHITE	
26	HM22-0013-90° vertical corner for recessed track rail	BLACK	
27	HM22-0013-90° vertical corner for recessed track rail	WHITE	





28	HM22-0001-1m SURFACE TRACK RAIL, WITH END CAP, WITH OVERLAY	BLACK
	HM22-0001-2m SURFACE TRACK RAIL, WITH END CAP, WITH OVERLAY	BLACK
29	HM22-0001-2m SURFACE TRACK RAIL, WITH END CAP, WITH OVERLAY	WHITE
30	HM22-0010-90° HORIZONTAL CORNER FOR SURFACE TRACK RAIL	BLACK
31	HM22-0010-90° HORIZONTAL CORNER FOR SURFACE TRACK RAIL	WHITE
32	HM22-0011-90° VERTICAL CORNER FOR SURFACE TRACK RAIL	BLACK
33	HM22-0011-90° VERTICAL CORNER FOR SURFACE TRACK RAIL	WHITE
34	HM22-0020-INSTALLATION CLIP FOR SURFACE TRACK RAIL, INSTALLATION CLIP FOR STRAIGHT	
35	PENDENT KIT FOR MAGNETIC TRACK RAIL-2*2m STEEL ROPE AND INSTALLATION ACCESSORIES	



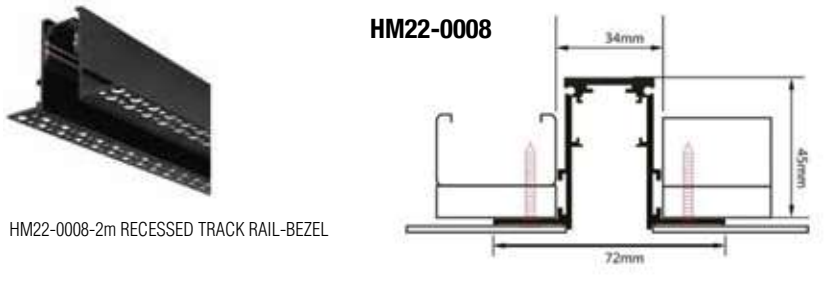

HM22-0001 SHEMATSKI PRIKAZ

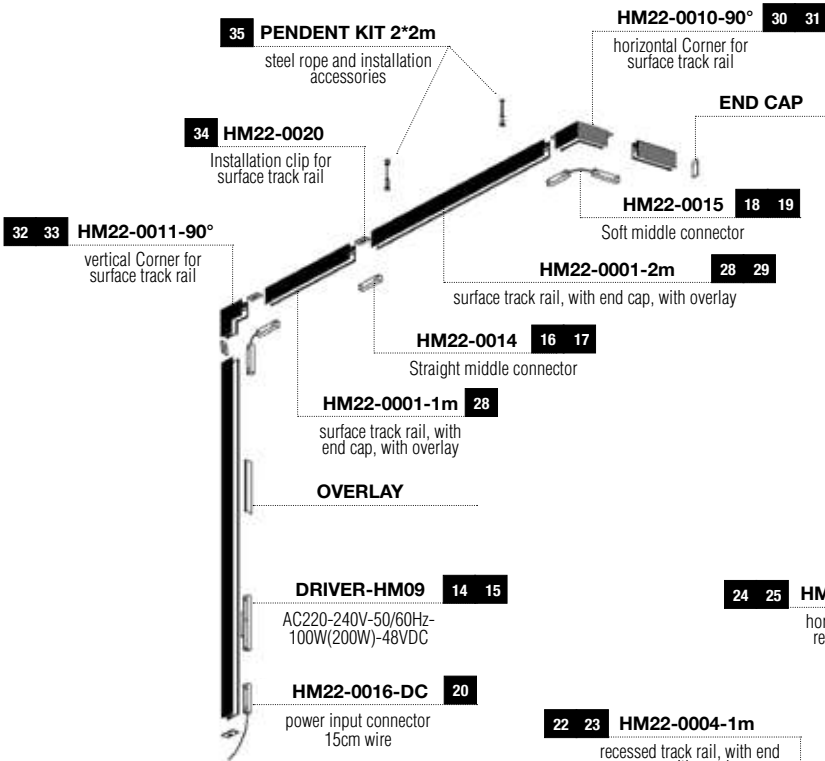



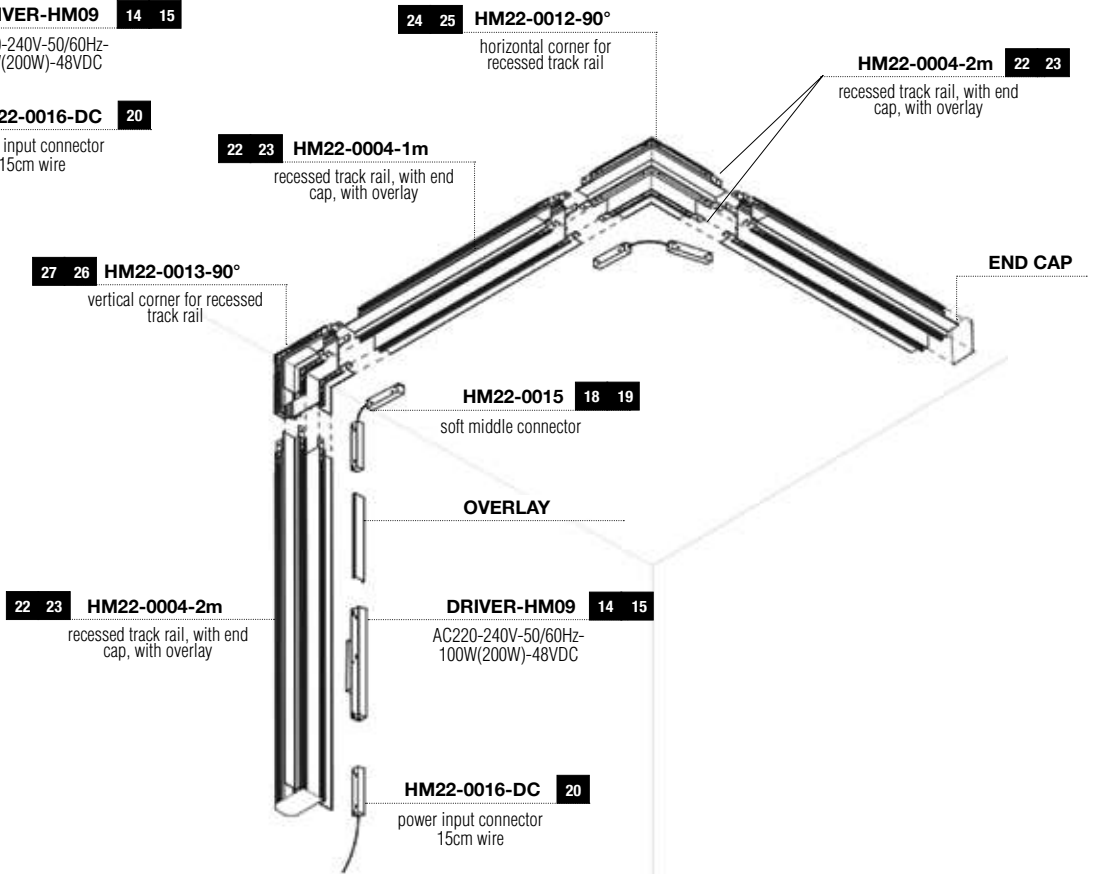



HM22-0004 SHEMATSKI PRIKAZ



TRAČNE TROFAZNE EU

1	TRACK LIGHT-TLGU4-GU10	WHITE	65x120mm
2	TRACK LIGHT-TLGU4-GU10	BLACK	65x120mm
3	TRACK LIGHT-TLGU4-GU10-LAMP	BLACK	65x120mm, POLE: 250mm
4	TRACK LIGHT-TLGU4-GU10-LAMP	BLACK	65x120mm, POLE: 450mm
5	TRACK LIGHT-TLGU5-GU10-LAMP, (dolazi sa ukrasnim prstenom u crnoj boji)	BLACK	D65x120mm, POLE: 70mm
6	COLOR REFLECTOR FOR TLGU5-GU10-GOLD, RAL2000 (ukrasni prsten u zlatnoj boji za TLG05)		
7	COLOR REFLECTOR FOR TLGU5-GU10-WHITE, RAL2000 (ukrasni prsten u bijeloj boji za TLG05)		



1	TRACK MINIMO 3P WH	SANDY WHITE	GU10/MR11	Ø39x77mm
2	TRACK MINIMO 3P BK	SANDY BLACK	GU10/MR11	Ø39x77mm
3	TRACK MINIMO 3P BRASS	BRASS COLOR	GU10/MR11	Ø39x77mm
4	TRACK MINIMO 3P BRONZE	BRONZE COLOR	GU10/MR11	Ø39x77mm
5	CCT LED TRACK LIGHT	 F	BLACK	2800 Lm, Ø77x178mm, 30W, PF0.9, 3000-6500K, RAa80, AC220-240V 50/60 Hz
6	CCT LED TRACK LIGHT	 F	WHITE	2800Lm, Ø77x178mm, 30W, PF0.9, 3000-6500K, RAa80, AC220-240V 50/60 Hz
7	LED-TRACK-TLKB-20	 G	BLACK	20W, CRI90, 3000K, 1600Lm, L611mm, 100°, PC optic, DF >0.9, AC220-240V, IP20
7	LED-TRACK-TLKB-20	 G	BLACK	20W, CRI90, 4000K, 1600Lm, L611mm, 100°, PC optic, DF >0.9, AC220-240V, IP20
8	LED-TRACK-TLKC-20	 E	BLACK	20W, CRI90, 3000K, 2000Lm, L611mm, 36°, LENS optic, DF >0.9, AC220-240V, IP20
8	LED-TRACK-TLKC-20	 E	BLACK	20W, CRI90, 4000K, 200Lm, L611mm, 36°, LENS optic, DF >0.9, AC220-240V, IP20

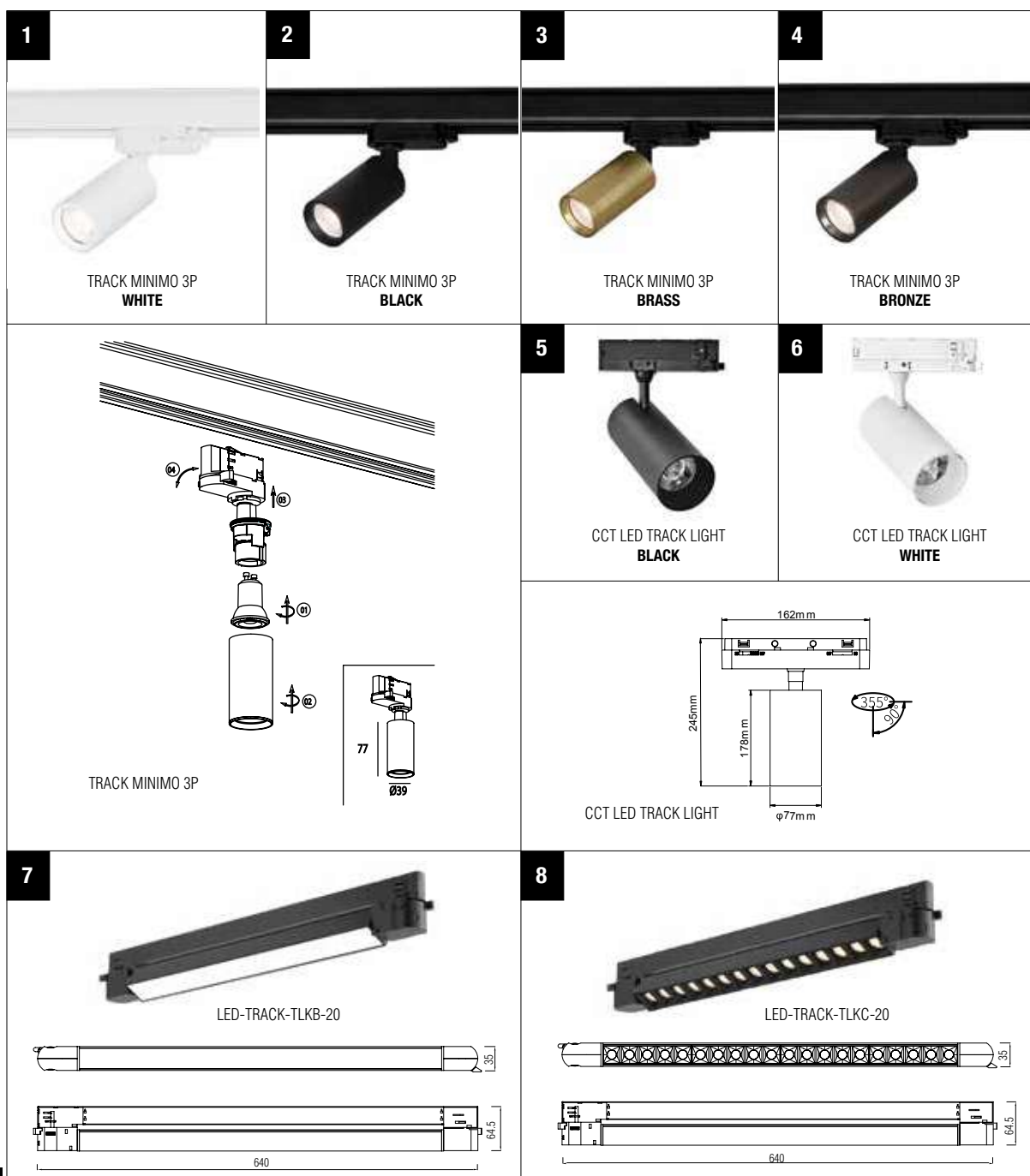

9	2 METERS OF TC 3 PHASE 4 WIRE TRACK RAIL	WHITE	32x35mm	19	4 WIRE TRIANGLE CONNECTOR (R1/R2/L1/L2)	WHITE
10	2 METERS OF TC 3 PHASE 4 WIRE TRACK RAIL	BLACK	32x35mm	20	4 WIRE TRIANGLE CONNECTOR (R1/R2/L1/L2)	BLACK
11	4 WIRE MIDDLE CONNECTOR INPUT	WHITE		21	REFLECTOR / PENDANT ADAPTER	WHITE
12	4 WIRE MIDDLE CONNECTOR INPUT	BLACK		22	REFLECTOR / PENDANT ADAPTER	BLACK
13	4 WIRE MINI MIDDLE CONNECTOR	WHITE		23	CEILING BASE FOR TRACK LIGHT Ø100mm	BLACK
14	4 WIRE MINI MIDDLE CONNECTOR	BLACK		24	OVJESNI MEHANIZAM ZA 3F ŠINU 1,2m	
15	4 WIRE END CAP	WHITE		25	4 WIRE POWER INPUT HEAD CONNECTOR	WHITE
16	4 WIRE END CAP	BLACK		26	4 WIRE POWER INPUT HEAD CONNECTOR	BLACK
17	4 WIRE CORNER CONNECTOR (R/L)	WHITE				
18	4 WIRE CORNER CONNECTOR (R/L)	BLACK				







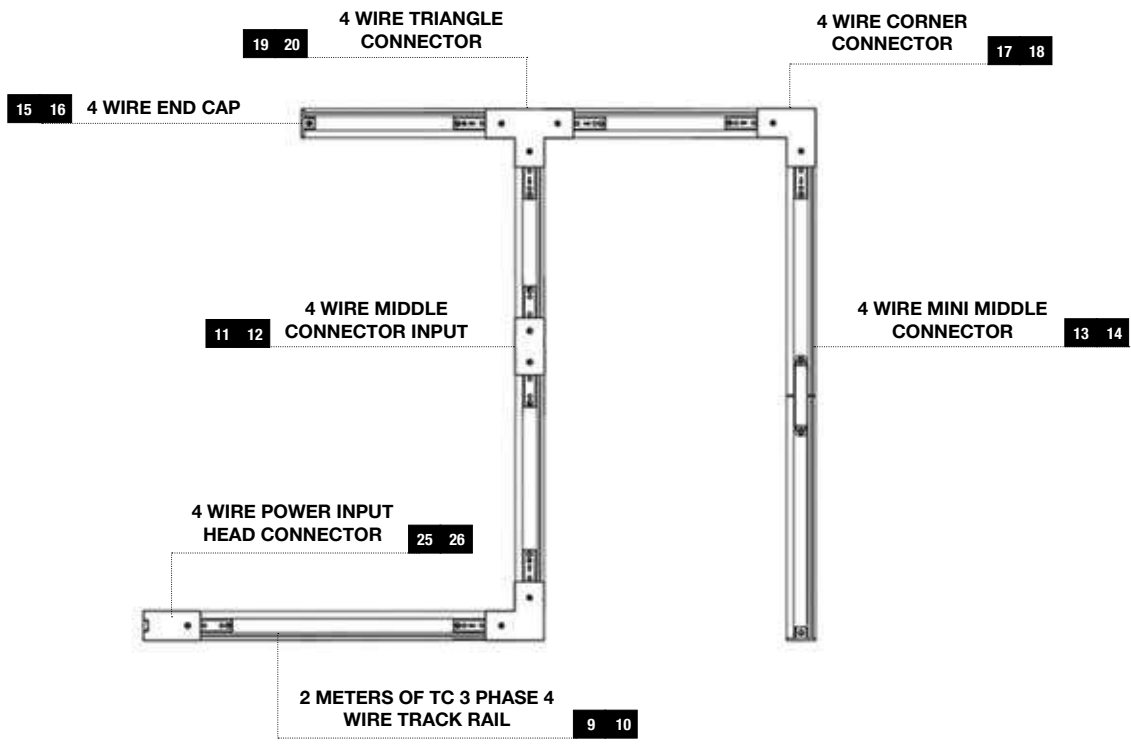

27	LED TRACK-TLJ08030-AC220-240V-30W-3000K-2700lm-36°	BLACK	Ø80x180mm	
	LED TRACK-TLJ08030-AC220-240V-30W-4000K-2700lm-36°	BLACK	Ø80x180mm	
28	LED TRACK-TLJ08030-AC220-240V-30W-3000K-2700lm-36°	WHITE	Ø80x180mm	
	LED TRACK-TLJ08030-AC220-240V-30W-4000K-2700lm-36°	WHITE	Ø80x180mm	
29	LENS FOR TLJ TRACK LIGHT 15°			
30	LENS FOR TLJ TRACK LIGHT 24°			



EU 3F SHEMATSKI PRIKAZ



MAGNETIC MINI SLIM

1	LED-SMA-2-48VDC-6W-420lm-3000K	280mm	BLACK	
2	LED-SMA-2-48VDC-12W-840lm-3000K	500mm	BLACK	
3	LED-SMB-1-48VDC-10W-800lm-3000K	400mm	BLACK	
4	LED-SMB-1-48VDC-20W-1600lm-3000K	650mm	BLACK	
5	LED-SMC-1-48VDC-6W-480lm-3000K, 36°	Ø35x100mm	BLACK	
6	LED-SMC-1-48VDC-12W-960lm-3000K, 36°	Ø45x120mm	BLACK	
7	LED-SMEB-1-48VDC-7W-560lm-3000K, 24°, 1m	Ø35x200mm, cable 1m	BLACK	

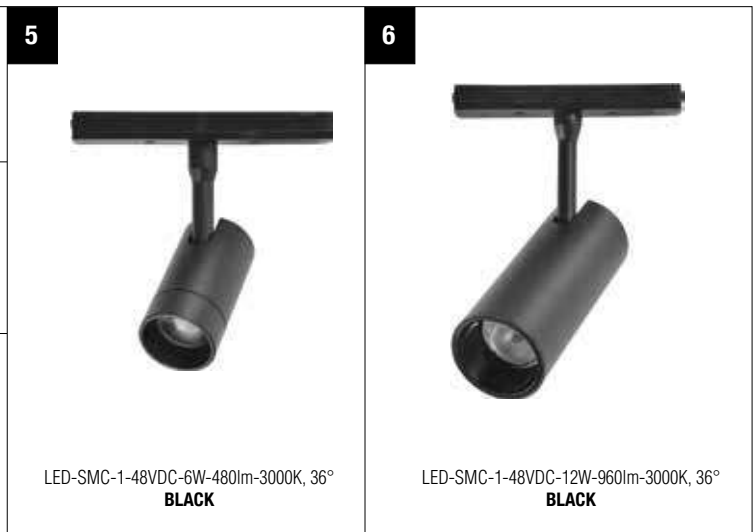

8	DRIVER-48V TRACK DRIVER, 100W, 20cm INPUT CABLE	295mm	BLACK
9	DRIVER-48V TRACK DRIVER, 200W, 20cm INPUT CABLE	395mm	BLACK
10	ACCESSORY-SMR-IP, INPUT HEAD CONNECTOR WITH 20cm CABLE		BLACK
11	ACCESSORY-SMR-CC, CORNER CONNECTOR FOR TRACK RAIL		BLACK
12	ACCESSORY-SMR-MC, MIDDLE CONNECTOR FOR TRACK RAIL		BLACK
13	ACCESSORY-SMR-TC, SHAPE CONNECTOR FOR TRACK RAIL		BLACK
14	ACCESSORY-SMR-XC, SHAPE CONNECTOR FOR TRACK RAIL		BLACK
15	ACCESSORY-SMR-LC, L CORNER CONNECTOR FOR TRACK RAIL		BLACK
16	SMR TRACK RAIL, 1 METER TRACK RAIL WITH COVER AND TWO END CAPS	28x8mm	BLACK
17	SMR TRACK RAIL, 2 METER TRACK RAIL WITH COVER AND TWO END CAPS	28x8mm	BLACK



SKYLINE

SKY-06A840B 6M LENGHT, 20MM WIDTH, BLACK, SET

SKY-12C840B 12M LENGHT, 20MM WIDTH, BLACK, SET



LMB8001-3/4/5 F A T G

LMB8001-3	STARRY SKY GREY	18W
LMB8001-3	GOLD	18W
LMB8001-3	CARBON FIBER	18W
LMB8001-4	STARRY SKY GREY	24W
LMB8001-4	GOLD	24W
LMB8001-4	CARBON FIBER	24W
LMB8001-5	STARRY SKY GREY	30W
LMB8001-5	CARBON FIBER	30W
LMB8001-5	STARRY SKY GREY	30W

- Bridgelux chip, Ra:90, 88Lm/W, CCT:2700K-4500K-6000K, Angle: 36°, aluminium, IP20, 36V, CCT dimmable



LMB8001-3 STARRY CARBON FIBER



LMB8001-4 STARRY CARBON FIBER



LMB8001-5 STARRY CARBON FIBER

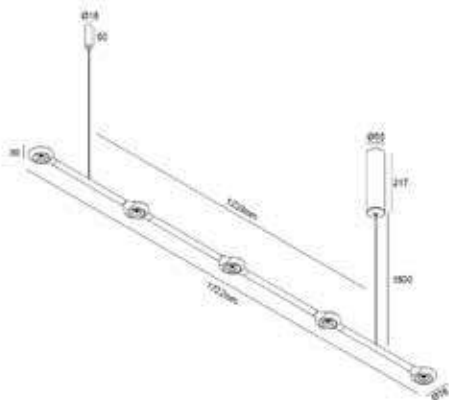
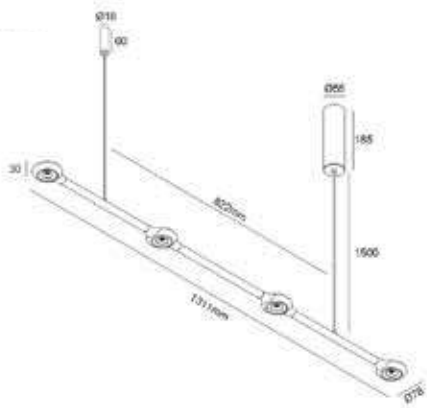
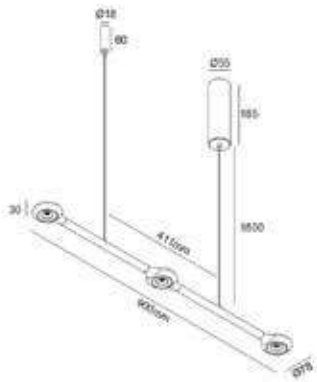



LMB8001-3 STARRY SKY GREY



LMB8001-3 STARRY GOLD



LMB8001-4 STARRY SKY GREY



LMB8001-4 STARRY GOLD



LMB8001-5 STARRY SKY GREY

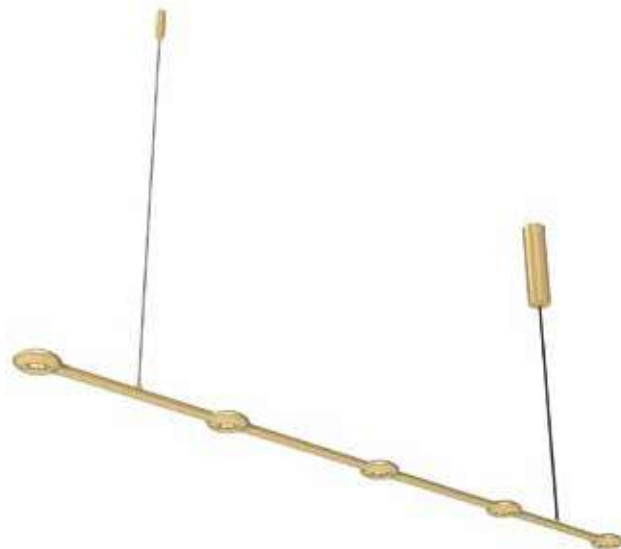

LMB8001-5 STARRY GOLD

LM29130

LM29130 WHITE

LM29130 BLACK

LM29130 SILVER

LM29130 GOLD

Aluminium, IP20, Cut-out size 76mm, Ø92*h22mm



LM29130 WHITE



LM29130 BLACK



LM29130 SILVER



LM29130 GOLD



LM29130R WHITE



LM29130R BLACK



LM29130R SILVER



LM29130R GOLD

LM29130R

LM29130 WHITE

LM29130 BLACK

LM29130 SILVER

LM29130 GOLD

ALUMINIUM, GU10 HOLDER, IP20, Ø68*h26mm



WHITE/BLACK



WHITE/SILVER



WHITE/GOLD



BLACK/WHITE



BLACK/SILVER

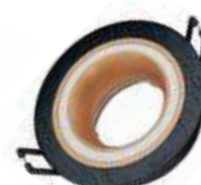

BLACK/GOLD



SILVER/WHITE



SILVER/BLACK

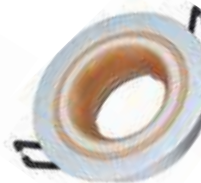

SILVER/GOLD



GOLD/WHITE



GOLD/BLACK



GOLD/SILVER

LM29131

LM29131 WHITE

LM29131 BLACK

LM29131 SILVER

LM29131 GOLD

Aluminium, IP20, Cut-out size 76mm, 92x92*h22mm



LM29131 WHITE

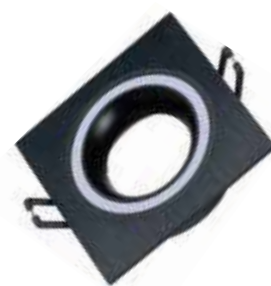

LM29131 BLACK

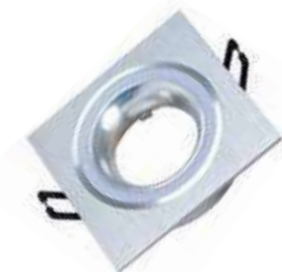

LM29131 SILVER

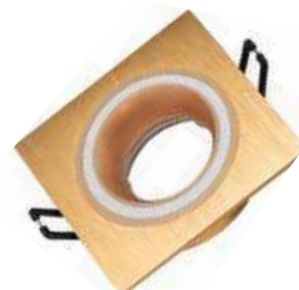

LM29131 GOLD



LM29130R WHITE



LM29130R BLACK



LM29130R SILVER



LM29130R GOLD

LM29130R

LM29130 WHITE

LM29130 BLACK

LM29130 SILVER

LM29130 GOLD

ALUMINIUM, GU10 HOLDER, IP20, Ø68*h26mm



WHITE/BLACK



WHITE/SILVER

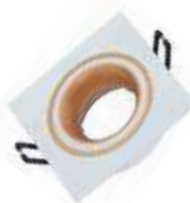

WHITE/GOLD



BLACK/WHITE



BLACK/SILVER

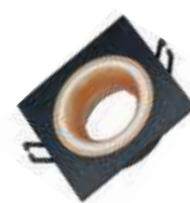

BLACK/GOLD



SILVER/WHITE

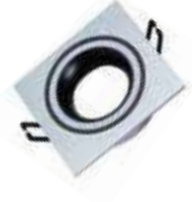

SILVER/BLACK

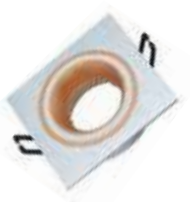

SILVER/GOLD

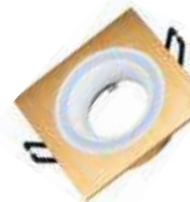

GOLD/WHITE



GOLD/BLACK

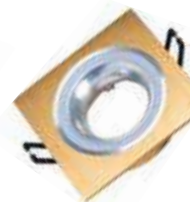

GOLD/SILVER

LM29134

LM29134 BLACK

LM29134 WHITE

Aluminium, IP20, Cut-out size 65mm, Ø72*h42mm



LM29134 BLACK



LM29134 WHITE



LM29134 RING BLACK



LM29134 RING WHITE

LM29134 RING

LM29134 RING BLACK

LM29134 RING WHITE

Aluminium, IP20, Ø75*h10mm

LM9039

LM9039 SAND WHITE/SILVER

LM9039 SAND BLACK/GOLD

Aluminium, IP20, Cut-out size 60mm, Ø68*h72mm, includes GU10 lampholder



LM9039
SAND WHITE+ SILVER



LM9039
SAND BLACK+ GOLD



LM9041

LM9041 SAND WHITE/SILVER

LM9041 SAND BLACK/GOLD

Aluminium, IP20, Cut-out size 60mm, Ø68*h55mm, includes GU10 lampholder



LM9041
SAND BLACK+GOLD



LM9041
SAND WHITE+SILVER



LM9042
SAND BLACK+GOLD



LM9042
SAND WHITE+SILVER

LM9042

LM9042 SAND WHITE/SILVER

LM9042 SAND BLACK/GOLD

Aluminium, IP20, Cut-out size 60mm, Ø68*h55mm, includes GU10 lampholder

LM1022B

LM1022B WHITE

LM1022B BLACK

Aluminium, IP20, Ø120*80mm, AR111, includes GU10 lampholder



LM1022B WHITE



LM1022B BLACK



R-3160-GU

R-3160-GU BLACK

R-3160-GU DARK GREY

R-3160-GU WHITE

▪ **Dimension:** Ø114mm ▪ Ø104mm 



R-3160-GU BLACK



R-3160-GU DARK GREY



R-3160-GU WHITE



SILVER



BLACK



GOLD



WH

ROUND REFLECTOR

ROUND REFLECTOR SILVER

ROUND REFLECTOR BLACK

ROUND REFLECTOR GOLD

ROUND REFLECTOR WHITE



BK/GOLD



BK/WH



BK/SILVER



DG/BK



DG/GOLD



DG/WH



WH/BK



WH/GOLD



WH/SILVER

S-3161-GU

S-3161-GU BLACK

S-3161-GU DARK GREY

S-3161-GU WHITE

▪ **Dimension:** 114x114mm ▪ Ø104mm 



R-3161-GU BLACK



R-3161-GU DARK GREY



R-3161-GU WHITE



SILVER



BLACK



GOLD



WH

ROUND REFLECTOR

ROUND REFLECTOR SILVER

ROUND REFLECTOR BLACK

ROUND REFLECTOR GOLD

ROUND REFLECTOR WHITE



BK/GOLD



BK/WH



BK/SILVER



DG/BK



DG/GOLD



DG/WH



WH/BK



WH/GOLD



WH/SILVER

S-3162-GU

S-3162-GU BK BLACK

S-3162-GU BK DARK GREY

S-3162-GU BK WHITE

▪ **Dimension:** 115x233mm ▪ 100x222mm 



S-3162-GU BLACK



S-3162-GU DARK GREY



S-3162-GU WHITE



SILVER



BLACK



GOLD



WH

ROUND REFLECTOR

ROUND REFLECTOR SILVER

ROUND REFLECTOR BLACK

ROUND REFLECTOR GOLD

ROUND REFLECTOR WHITE



BK/GOLD



BK/WH



BK/SILVER



DG/BK



DG/GOLD



DG/WH



WH/BK



WH/GOLD



WH/SILVER

ROTONDO R+130/96 ALU



ROTONDO R+130/96 ALU BLACK ROTONDO R+130/96 ALU DARK GREY ROTONDO R+130/96 ALU SILVER ROTONDO R+130/96 ALU WHITE

ROTONDO R+130/96 ALU	BLACK
ROTONDO R+130/96 ALU	DARK GREY
ROTONDO R+130/96 ALU	SILVER
ROTONDO R+130/96 ALU	WHITE

230V-50Hz, GU10, MAX 50W

▪ Dimenzije:

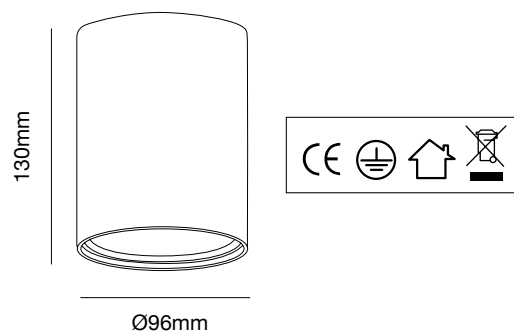

SILVER

BLACK



GOLD

WH

ROUND REFLECTOR

ROUND REFLECTOR	SILVER
ROUND REFLECTOR	BLACK
ROUND REFLECTOR	GOLD
ROUND REFLECTOR	WHITE



BK/SILVER



BK/GOLD



BK/WH



DARK GREY/BK



DARK GREY/GOLD



DARK GREY/WH



SILVER/BK



SILVER/GOLD



SILVER/WH



WHITE/SILVER



WHITE/BK



WHITE/GOLD

ROTONDO R+254/96 ALU

ROTONDO R+254/96 ALU	BLACK
ROTONDO R+254/96 ALU	DARK GREY
ROTONDO R+254/96 ALU	SILVER
ROTONDO R+254/96 ALU	WHITE

230V~50Hz, GU10, MAX 50W



SILVER



BLACK



GOLD



WH



BK/BK

DARK GREY/
SILVER

SILVER/SILVER

WHITE/WH

▪ Dimenzije:

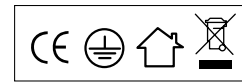
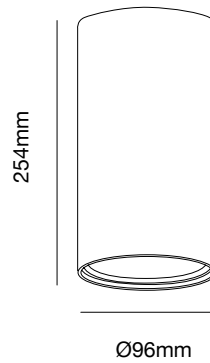

ROUND REFLECTOR

ROUND REFLECTOR	SILVER
ROUND REFLECTOR	BLACK
ROUND REFLECTOR	GOLD
ROUND REFLECTOR	WHITE



BK/SILVER



BK/GOLD



BK/WH



DARK
GREY/BK



DARK
GREY/GOLD



DARK
GREY/WH



SILVER/BK



SILVER/GOLD



SILVER/WH



WHITE/SILVER



WHITE/BK



WHITE/GOLD



S-ROTONDO R+254/96 ALU

S-ROTONDO R+254/96 ALU	BLACK
S-ROTONDO R+254/96 ALU	DARK GREY
S-ROTONDO R+254/96 ALU	SILVER
S-ROTONDO R+254/96 ALU	WHITE

230V~50Hz, GU10, MAX 50W



SILVER

BLACK



GOLD

WHITE

ROUND REFLECTOR

ROUND REFLECTOR	SILVER
ROUND REFLECTOR	BLACK
ROUND REFLECTOR	GOLD
ROUND REFLECTOR	WHITE



▪ **Dimenzije:**

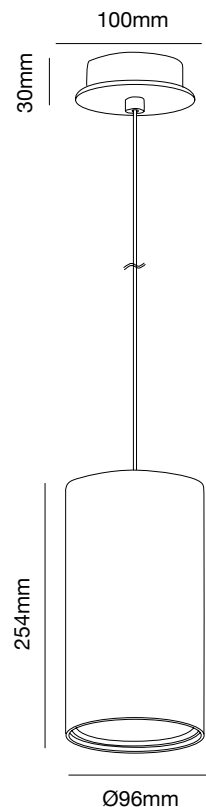

BK/SILVER

BK/GOLD

BK/WH



DARK
GREY/BK

DARK
GREY/GOLD

DARK
GREY/WH



SILVER/BK

SILVER/GOLD

SILVER/WH



WHITE/SILVER

WHITE/BK

WHITE/GOLD

P-TUBO 30/40/60

P-TUBO 30 SWH	SAND WHITE	GU10
P-TUBO 30 SBK	SAND BLACK	GU10
P-TUBO 30 BRASS	BRASS COLOR	GU10
P-TUBO 30 BRONZE	BRONZE COLOR	GU10

▪ **Dimension:** Canopy: Ø10 x Cable: H140, Tube: Ø5.5 x 30

P-TUBO 40 SWH	SAND WHITE	GU10
P-TUBO 40 SBK	SAND BLACK	GU10
P-TUBO 40 BRASS	BRASS COLOR	GU10
P-TUBO 40 BRONZE	BRONZE COLOR	GU10

▪ **Dimension:** Canopy: Ø10 x Cable: H140, Tube: Ø5.5 x 40

P-TUBO 60 SWH	SAND WHITE	GU10
P-TUBO 60 SBK	SAND BLACK	GU10
P-TUBO 60 BRASS	BRASS COLOR	GU10
P-TUBO 60 BRONZE	BRONZE COLOR	GU10

▪ **Dimension:** Canopy: Ø10 x Cable: H140, Tube: Ø5.5 x 50

▪ **PENDANT LAMP WITH 2m CABLE, BULB NOT INCLUDED**

▪ **MATERIAL: ALUMINIUM, PACKING: WHITE BOX**



40 BRASS 40 BRONZE 40 BLACK 40 WHITE



60 BRASS 60 BRONZE 60 BLACK 60 WHITE



30 BRASS 30 BRONZE 30 BLACK 30 WHITE

ROTONDO 125/96 ALU



BK

▪ **Dimenzije:**

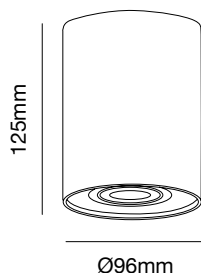

ROTONDO 125/96 ALU	BK	230V~50Hz, GU10, MAX 50W
ROTONDO 125/96 ALU	DARK GREY	230V~50Hz, GU10, MAX 50W
ROTONDO 125/96 ALU	SILVER	230V~50Hz, GU10, MAX 50W
ROTONDO 125/96 ALU	WHITE	230V~50Hz, GU10, MAX 50W



DARK GREY



SILVER



WHITE

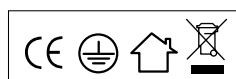

ROTONDO MINI 100/56 ALU

ROTONDO MINI 100/96 ALU	BK	230V~50Hz, GU10, MAX 50W
ROTONDO MINI 100/96 ALU	DARK GREY	230V~50Hz, GU10, MAX 50W
ROTONDO MINI 100/96 ALU	SILVER	230V~50Hz, GU10, MAX 50W
ROTONDO MINI 100/96 ALU	WHITE	230V~50Hz, GU10, MAX 50W
ROTONDO MINI 100/96 ALU	BRASS	230V~50Hz, GU10, MAX 50W
ROTONDO MINI 100/96 ALU	BRONZE	230V~50Hz, GU10, MAX 50W



SILVER

▪ **Dimenzije:**

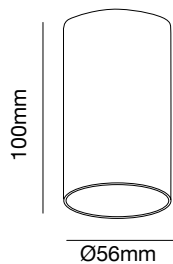

BK



DARK GREY



WHITE



BRASS



BRONZE



LM 1004

LM1004R	CHROME	230V-50Hz, GU10, max. 50W
LM1004R	COFFEE	230V-50Hz, GU10, max. 50W
LM1004R	BLACK CHROME	230V-50Hz, GU10, max. 50W
LM1004R	BRASS	230V-50Hz, GU10, max. 50W

▪ Dimenzije: Ø96x140mm



CHROME



COFFEE



BLACK CHROME



BRASS



LM 1004R



CHROME



COFFEE



BLACK CHROME



BRASS

LM1004R CHROME

LM1004R COFFEE

LM1004R BLACK CHROME

LM1004R BRASS

RETTANGOLARE R+130/96 ALU

RETTANGOLARE R+130/96 ALU	BLACK
RETTANGOLARE R+130/96 ALU	DARK GREY
RETTANGOLARE R+130/96 ALU	SILVER
RETTANGOLARE R+130/96 ALU	WHITE

230V~50Hz, GU10, MAX 50W



▪ **Dimenzije:**

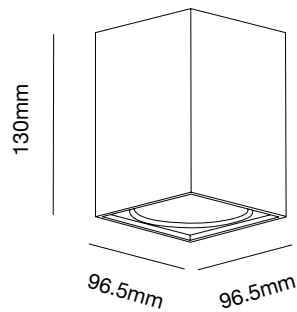

SQUARE REFLECTOR

ROUND REFLECTOR	SILVER
ROUND REFLECTOR	BLACK
ROUND REFLECTOR	GOLD
ROUND REFLECTOR	WHITE





RETTANGOLARE DOPPIO R+130/96X2 ALU



BLACK

RETTANGOLARE DOPPIO R+130/96X2 ALU BLACK

RETTANGOLARE DOPPIO R+130/96X2 ALU DARK GREY

RETTANGOLARE DOPPIO R+130/96X2 ALU SILVER

RETTANGOLARE DOPPIO R+130/96X2 ALU WHITE



DARK GREY



/SILVER



WHITE/WH

230V-50Hz, GU10, MAX 50W

▪ Dimenzije:

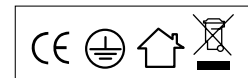
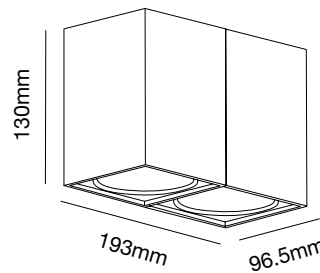

SILVER



BLACK



GOLD



WHITE

SQUARE REFLECTOR

SQURE REFLECTOR SILVER

SQURE REFLECTOR BLACK

SQURE REFLECTOR GOLD

SQURE REFLECTOR WHITE



BK/SILVER



BK/GOLD



BK/WH



DARK GREY/BK



DARK GREY/GOLD



DARK GREY/WH



SILVER/BK



SILVER/GOLD



SILVER/WH



WHITE/SILVER



WHITE/BK



WHITE/GOLD

RETTANGOLARE R+254/96 ALU

RETTANGOLARE R+254/96 ALU BLACK

RETTANGOLARE R+254/96 ALU DARK GREY

RETTANGOLARE R+254/96 ALU SILVER

RETTANGOLARE R+254/96 ALU WHITE

230V-50Hz, GU10, MAX 50W



SILVER

BLACK

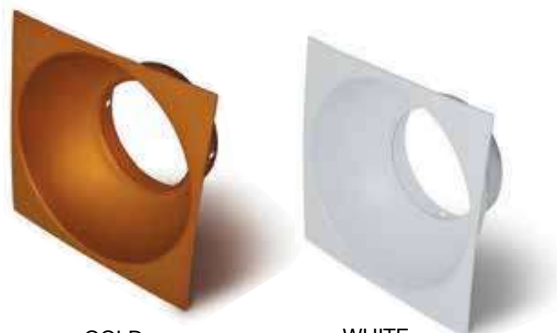

GOLD

WHITE



BLACK

DARK GREY

SILVER

WHITE

▪ Dimenzije:

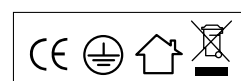
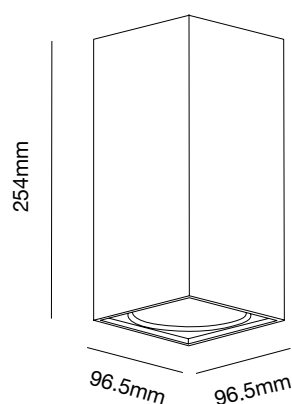

SQUARE REFLECTOR

SQUARE REFLECTOR SILVER

SQUARE REFLECTOR BLACK

SQUARE REFLECTOR GOLD

SQUARE REFLECTOR WHITE



BK/SILVER



BK/GOLD



BK/WH



DARK
GREY/BK



DARK
GREY/GOLD



DARK
GREY/WH



SILVER/BK



SILVER/GOLD



SILVER/WH



WHITE/SILVER



WHITE/BK



WHITE/GOLD

SD-C017S-5W



SD-C017S-5W BK MATT BLACK CCT, 420Lm, 36°, UGR<19, LED COB DOWNLIGHT, WITHOUT REFLECTOR

SD-C017S-5W WH MATT WHITE CCT, 420Lm, 36°, UGR<19, LED COB DOWNLIGHT, WITHOUT REFLECTOR

▪ **Dimension:** Ø60x35mm

▪ Ø54mm



SD-C017S-5W-BK



SD-C017S-5W-WH

REFLECTOR FOR SD-C017S-5W

MATT WHITE REFLECTOR

MATT BLACK REFLECTOR

MATT SILVER REFLECTOR

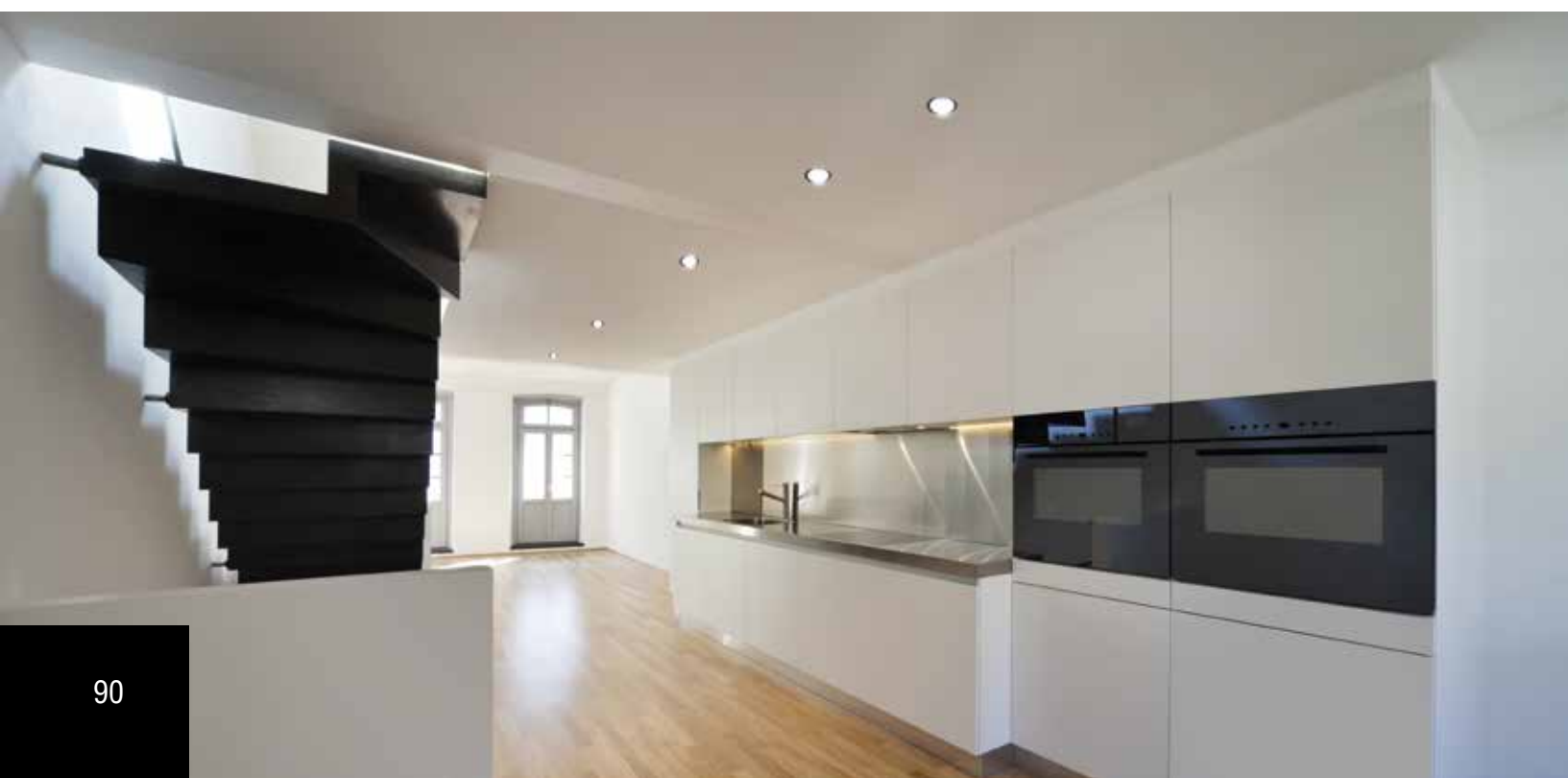

ELC-3160

ELC-3160 MATT WHITE GU10

ELC-3160 MATT BLACK GU10

▪ **Dimension:** Ø105x94mm ▪ Ø94mm 

CE  30°   IP20  



ELC-3160 MATT WHITE



ELC-3160 MATT BLACK



ELC-3280 MATT WHITE



ELC-3280 BLACK

ELC-3280

ELC-3280 MATT WHITE GU10

ELC-3280 BLACK GU10

▪ **Dimension:** Ø85x66mm ▪ Ø77mm 

30°   IP20  

HERA 1 ROUND

HERA 1 ROUND BK SAND BLACK 1xGU10, IP20

HERA 1 ROUND WH SAND WHITE 1xGU10, IP20

▪ **Dimension:** Ø105, h=60mm ▪ Ø90mm 



HERA 1 ROUND BK



HERA 1 ROUND WH

ARES 1 ROUND

ARES 1 ROUND BK SAND BLACK 1xGU10, IP20

ARES 1 ROUND WH SAND WHITE 1xGU10, IP20

ARES 1 ROUND BRASS MATT BRASS 1xGU10, IP20

ARES 1 ROUND BRONZE MATT BRONZE 1xGU10, IP20

▪ **Dimension:** Ø100, h=100mm

▪ Ø80mm



ARES 1 ROUND BK



ARES 1 ROUND WH



ARES 1 ROUND BRASS



ARES 1 ROUND BRONZE



ELC-218N

ELC-218N NM GU10

ELC-218N WH GU10

ELC-218N MBK GU10

▪ **Dimension:** Ø110mm ▪ Ø90mm 

 MAX 50W  E  III IP20  0.5m  45°  350°



LED 12V; 230V



HALOGEN 12V; 230V



CFL 230V



ELC-218N NM



ELC-218N WH



ELC-218N MBK



LM 5002M

LM 5002M	BLACK CHROME	GU10
LM 5002M	BRASS	GU10
LM 5002M	CHROME	GU10
LM 5002M	COFFEE	GU10

▪ **Dimension:** Ø90mm ▪ Ø70mm 



BLACK CHROME



BRASS



CHROME



COFFEE



ELC-229

ELC-229 MATT WH MR16 (GU10)

ELC-229 WH MR16 (GU10)

ELC-229 CH MR16 (GU10)

ELC-229 NM MR16 (GU10)

ELC-229 GM MR16 (GU10)

ELC-229 MATT BLACK MR16 (GU10)

▪ **Dimension:** Ø83mm

▪ Ø75mm 



IP20



ELC-229 MATT BLACK



ELC-229 MATT WH



ELC-229 WH



ELC-229 CH



ELC-229 NM





ELC-229 GM



ELC-205

ELC-205 WH	MR16 (GU10)
ELC-205 CH	MR16 (GU10)
ELC-205 NM	MR16 (GU10)
ELC-205 GM	MR16 (GU10)
ELC-205 MATT WHITE	MR16 (GU10)
ELC-205 MATT BLACK	MR16 (GU10)

▪ **Dimension:** Ø80x30mm ▪ Ø58mm 

CE  IP20  



ELC-205 WH



ELC-205 CH



ELC-205 NM



ELC-205 MATT WHITE



ELC-205 MATT BLACK







ELC-205 GM



ELC-212 (3009)

ELC-212 WH (3009)	MR16 (GU10)
ELC-212 CH (3009)	MR16 (GU10)
ELC-212 NM (3009)	MR16 (GU10)
ELC-212 GM (3009)	MR16 (GU10)

▪ **Dimension:** Ø102x38.5mm ▪ Ø80mm 

CE  IP20  0.5m  III  45°



ELC-212 WH (3009)



ELC-212 CH (3009)



ELC-212 NM (3009)



ELC-212 GM (3009)



APL 4391, 4392, 4393 BRUSH ALU

APL 4391 BRUSH ALU

MR16 (GU10)

▪ **Dimension:** 92x92x54mm

▪ Ø80mm 

APL 4392 BRUSH ALU

2 x MR16 (GU10)

▪ **Dimension:** 175x92x85mm

▪ 165x80mm 

APL 4393 BRUSH ALU

3 x MR16 (GU10)

▪ **Dimension:** 260x92x85mm

▪ 245x80mm 



APL 4391 BRUSH ALU

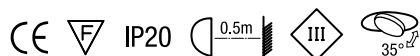

APL 4392 BRUSH ALU



APL 4393 BRUSH ALU



APL 8205,339, 9205 BRUSH ALU

APL 8205 BRUSH ALU

MR16 (GU10)

▪ **Dimension:** Ø90x42mm

▪ Ø75mm 

APL 339 BRUSH ALU

MR16 (GU10)

▪ **Dimension:** Ø92x54mm

▪ Ø80mm 

APL 9205 BRUSH ALU

MR16 (GU10)

▪ **Dimension:** 90x90x42mm

▪ Ø75mm 

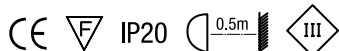

APL 8205 BRUSH ALU



APL 9205 BRUSH ALU



APL 339 BRUSH ALU



APL 4391S BRUSH ALU

APL 4391S BRUSH ALU

APL 4391S BRUSH ALU

GU10

▪ **Dimension:** 90x90x85mm



APL-2291NF, APL-1602F

APL-2291NF

G5.3 (GU10) IP65

▪ Ø70mm



APL-1602F

G5.3 (GU10) IP65

▪ Ø62mm



APL-2291NF



APL-1602F

APL 4391, 4392, 4393 MATT WH (ALU)

APL 4391 MATT WH (ALU)

MR16 (GU10)

▪ **Dimension:** 92x92x54mm

▪ Ø80mm 

APL 4392 MATT WH (ALU)

MR16 (GU10)

▪ **Dimension:** 175x92x85mm

▪ 165x80mm 

APL 4393 MATT WH (ALU)

MR16 (GU10)

▪ **Dimension:** 260x92x85mm

▪ 245x80mm 

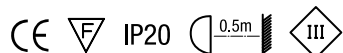

APL 4391 MATT WH (ALU)



APL 4392 MATT WH (ALU)



APL 4393 MATT WH (ALU)



APL 8205 MATT WH (ALU)



APL 9205 MATT WH (ALU)

APL 8205, 9205 MATT WH (ALU)

APL 8205 MATT WH (ALU)

MR16 (GU10)

▪ **Dimension:** Ø90x42mm

▪ Ø75mm 

APL 9205 MATT WH (ALU)

MR16 (GU10)

▪ **Dimension:** 90x90x42mm

▪ Ø75mm 

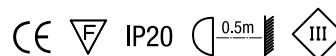

APL 4391-2, 4392-2, 4393-2 BLACK ALU

APL 4391-2 BLACK ALU

MR16 (GU10)

▪ **Dimension:** 92x92x54mm

▪ Ø80mm 

APL 4392-2 BLACK ALU

MR16 (GU10)

▪ **Dimension:** 175x92x85mm

▪ 165x80mm 

APL 4393-2 BLACK ALU

MR16 (GU10)

▪ **Dimension:** 260x92x85mm

▪ 245x80mm 

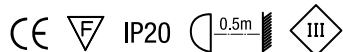

APL 4391-2 BLACK ALU



APL 4392-2 BLACK ALU



APL 4393-2 BLACK ALU



APL 8205 BLACK ALU



APL 339-2 BLACK ALU



APL 9205 BLACK ALU

APL 8205, 339-2, 9205 BLACK ALU

APL 8205 BLACK ALU

MR16 (GU10)

▪ **Dimension:** Ø90x42mm

▪ Ø75mm 

APL 339-2 BLACK ALU

MR16 (GU10)

▪ **Dimension:** Ø92x54mm

▪ Ø80mm 

APL 9205 BLACK ALU



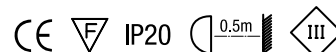

MR16 (GU10)

▪ **Dimension:** 90x90x42mm

▪ Ø75mm 



R 60A, Q61A, Q1661, Q1662 ALU WH

R 60A ALU	WHITE	230V~50Hz, GU10, MAX 50W
▪ Dimension: Ø76x37mm	▪ Ø64mm	
Q 61A ALU	WHITE	230V~50Hz, GU10, MAX 50W
▪ Dimension: 77x77x37mm	▪ Ø68mm	
Q 1661 ALU	WHITE	230V~50Hz, GU10, MAX 50W
▪ Dimension: 110x110x37mm	▪ 98x98mm	
Q 1662 ALU	WHITE	230V~50Hz, GU10, 2xMAX 50W
▪ Dimension: 206x110x37mm	▪ 98x192mm	



R 60A ALU WH



Q 61A ALU WH



Q 1662 ALU WH



Q 1661 ALU WH



Q 2161, Q 2162 ALU WH/ALU ALU

Q 2161 ALU WH 230V~50Hz, GU10, MAX 50W

Q 2161 ALU ALU 230V~50Hz, GU10, MAX 50W

▪ **Dimension:** 100x100x31mm ▪ Ø90mm 

Q 2162 ALU WH 230V~50Hz, GU10, 2xMAX 50W

Q 2162 ALU ALU 230V~50Hz, GU10, 2xMAX 50W

▪ **Dimension:** 198x100x31mm ▪ 90x180mm 



Q 2161 ALU ALU



Q 2162 ALU ALU



Q 2161 ALU WH



Q 2162 ALU WH

APL 4611, 4612, 4613 BRUSH ALU

APL 4611 BRUSH ALU AR111 (GU10)

▪ **Dimension:** 180x180x85mm ▪ Ø160mm 

APL 4612 BRUSH ALU 2 x AR111 (GU10)

▪ **Dimension:** 180x340x85mm ▪ 160x320mm 

APL 4613 BRUSH ALU 3 x AR111 (GU10)

▪ **Dimension:** 180x508x85mm ▪ 160x480mm 

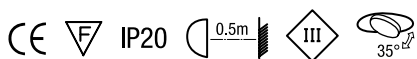

APL 4611 BRUSH ALU









APL 4612 BRUSH ALU



APL 4613 BRUSH ALU

APL 2611,3611 BRUSH ALU/BLACK ALU

APL 2611 BRUSH ALU	AR111 (GU10)
APL 2611 BLACK ALU	AR111 (GU10)
▪ Dimension: Ø158x85mm	▪ Ø138mm 
APL 3611 BRUSH ALU	AR111 (GU10)
APL 3611 BLACK ALU	AR111 (GU10)
▪ Dimension: Ø180x85mm	▪ Ø160mm 

CE  IP20   



APL 2611 BRUSH ALU



APL 3611 BRUSH ALU



APL 2611 BLACK ALU



APL 3611 BLACK ALU



APL 4611,4612,4613 BLACK ALU

APL 4611 BLACK ALU

AR111 (GU10)

- **Dimension:** 180x180x85mm
- \varnothing 160mm 

APL 4612 BLACK ALU

2 x AR111 (GU10)

- **Dimension:** 180x340x85mm
- 160x320mm 

APL 4613 BLACK ALU

3 x AR111 (GU10)

- **Dimension:** 180x508x85mm
- 160x480mm 

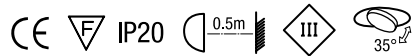

APL 4611 BLACK ALU







APL 4612 BLACK ALU



APL 4613 BLACK ALU



APL 4611, 4612, 4613, 2611, 3611 MATT WHITE

APL 4611 MATT WHITE	AR111 (GU10)
▪ Dimension: 180x180x85mm	▪ Ø160mm 
APL 4612 MATT WHITE	2 x AR111 (GU10)
▪ Dimension: 180x340x85mm	▪ 160x320mm 
APL 4613 MATT WHITE	3 x AR111 (GU10)
▪ Dimension: 180x508x85mm	▪ 160x480mm 
APL 2611 MATT WHITE	AR111 (GU10)
▪ Dimension: Ø158x85mm	▪ Ø138mm 
APL 3611 MATT WHITE	AR111 (GU10)
▪ Dimension: Ø180x85mm	▪ Ø160mm 

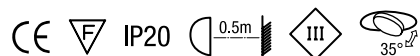

APL 4611 MATT WHITE



APL 4612 MATT WHITE



APL 4613 MATT WHITE



APL 3611 MATT WHITE



APL 2611 MATT WHITE

DL-60A-IP44

DL-60A-IP44-WH SANDY WHITE 1xGU10, IP44

DL-60A-IP44-BK SANDY BLACK 1xGU10, IP44

▪ **Dimension:** Ø82mm ▪ Ø72mm 



DL-60A-IP44-WH



DL-60A-IP44-BK



ELC-1101B WH/NM

ELC-1101B WH

MR16 IP65

ELC-1101B NM

MR16 IP65

▪ **Dimension:** Ø85mm

▪ Ø74mm 



LED 12V



HALOGEN 12V



ELC-1101B NM



ELC-1101B WH



ELC-1104B WH



ELC-1104B NM

ELC-1104B WH/NM

ELC-1104B WH

MR16 IP65

ELC-1104B NM

MR16 IP65

▪ **Dimension:** 82x82mm

▪ Ø74mm 



LED 12V



HALOGEN 12V

ELC-1203C1

ELC-1203C1 WH

MR16 IP65

ELC-1203C1 NM

MR16 IP65

ELC-1203C1 MATT BLACK

MR16 IP65

▪ **Dimension:** Ø100mm

▪ Ø80mm 



LED 12V



HALOGEN 12V



ELC-1203C1 WH



ELC-1203C1 NM



ELC-1203C1 MATT BLACK

TL-9082A IP44

TL-9082A MATT BLACK GU10, IP44

TL-9082A MATT WHITE GU10, IP44

▪ **Dimension:** 120x60mm ▪ Ø85mm 



TL-9082A MATT BLACK IP44



TL-9082A MATT WHITE IP44



LED-IP65-SMD-SPOT LIGHT 3000K/4000K

LED-IP65-SMD-SPOT LIGHT 3000K 230V, 5W, ROUND WHITE

LED-IP65-SMD-SPOT LIGHT 4000K 230V, 5W, ROUND WHITE

▪ **Dimension:** Ø87x45mm ▪ Ø63mm 

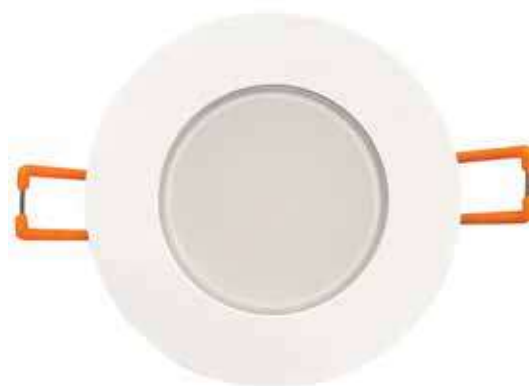

LED-IP65-SMD-SPOT LIGHT

ROTONDO 95/90 IP44

ROTONDO 95/90 IP44 SAND WHITE GU10, IP44

ROTONDO 95/90 IP44 SAND BLACK GU10, IP44

▪ Dimension: Ø90, h=95mm



ROTONDO 95/90 SAND BLACK IP44



ROTONDO 95/90 SAND WHITE IP44



TANGO BLACK IP66 0,8W

TANGO BLACK IP66 0,8W WALL LED LIGHT

- **Dimension:** 73x73mm
- **COLOR (K):** 3000K ili 4000K
- Ø60mm



TANGO BLACK IP66 0,8W

TANGO SHORT BLACK IP66 0,8W

TANGO SHORT BLACK IP66 0,8W WALL LED LIGHT

- **Dimension:** 73x73mm
- **COLOR (K):** 3000K ili 4000K
- Ø60mm



TANGO SHORT BLACK IP66 0,8W

RUEDA BLACK IP66 0,8W

RUEDA BLACK IP66 0,8W WALL LED LIGHT

- **Dimension:** Ø73mm
- **COLOR (K):** 3000K ili 4000K
- Ø60mm



RUEDA BLACK IP66 0,8W

RUEDA SHORT BLACK IP66 0,8W

RUEDA SHORT BLACK IP66 0,8W WALL LED LIGHT

- **Dimension:** Ø73mm
- **COLOR (K):** 3000K ili 4000K
- Ø60mm



RUEDA SHORT BLACK IP66 0,8W

TANGO WHITE IP66 0,8W

TANGO WHITE IP66 0,8W

WALL LED LIGHT

- **Dimension:** 73x73mm
- **COLOR (K):** 3000K ili 4000K
- Ø60mm



TANGO WHITE IP66 0,8W

TANGO SHORT WHITE IP66 0,8W

TANGO SHORT WHITE IP66 0,8W

WALL LED LIGHT

- **Dimension:** 73x73mm
- **COLOR (K):** 3000K ili 4000K
- Ø60mm



TANGO SHORT WHITE IP66 0,8W

RUEDA WHITE IP66 0,8W

RUEDA WHITE IP66 0,8W

WALL LED LIGHT

- **Dimension:** Ø73mm
- **COLOR (K):** 3000K ili 4000K
- Ø60mm



RUEDA WHITE IP66 0,8W

RUEDA SHORT WHITE IP66 0,8W

RUEDA SHORT WHITE IP66 0,8W

WALL LED LIGHT

- **Dimension:** Ø73mm
- **COLOR (K):** 3000K ili 4000K
- Ø60mm



RUEDA SHORT WHITE IP66 0,8W

TANGO STAINLESS STEEL 0,8W

TANGO STAINLESS STEEL 0,8W WALL LED LIGHT

- **Dimension:** 73x73x10,5mm
- **COLOR (K):** 3000K ili 4000K

▪ Ø60mm



TANGO STAINLESS STEEL 0,8W

TANGO SHORT STAINLESS STEEL IP56 0,8W

TANGO SHORT STAINLESS STEEL IP56 0,8W WALL LED LIGHT

- **Dimension:** 73X73X10,5mm
- **COLOR (K):** 3000K ili 4000K

▪ Ø60mm



TANGO SHORT STAINLESS
STEEL IP56 0,8W

RUEDA STAINLESS STEEL 0,8W

TANGO STAINLESS STEEL 0,8W WALL LED LIGHT

- **Dimension:** Ø73X10,5mm
- **COLOR (K):** 3000K ili 4000K

▪ Ø60mm



TANGO STAINLESS STEEL 0,8W

RUEDA SHORT STAINLESS STEEL IP56 0,8W

RUEDA SHORT STAINLESS STEEL IP56 0,8W WALL LED LIGHT

- **Dimension:** Ø73X10,5mm
- **COLOR (K):** 3000K ili 4000K

▪ Ø60mm



RUEDA SHORT STAINLESS
STEEL IP56 0,8W

TANGO BLACK IP66 10V WITH PIR SENSOR

TANGO BLACK IP66 10V

WALL LED LIGHT

- Dimension: 73x73mm
- COLOR (K): 3000K

- Ø60mm



TANGO BLACK IP66 10V
WITH PIR SENSOR

RUEDA BLACK IP66 10V WITH PIR SENSOR

TANGO SHORT WHITE IP66 0,8W

WALL LED LIGHT

- Dimension: Ø73mm
- COLOR (K): 3000K

- Ø60mm



RUEDA BLACK IP66 10V
WITH PIR SENSOR

TANGO S/S IP66 10V WITH PIR SENSOR

TANGO S/S IP66 10V

WALL LED LIGHT

- Dimension: 73x73mm
- COLOR (K): 3000K

- Ø60mm



TANGO S/S IP66 10V
WITH PIR SENSOR

RUEDA S/S IP66 10V WITH PIR SENSOR

RUEDA S/S IP66 10V

WALL LED LIGHT

- Dimension: Ø73mm
- COLOR (K): 3000K

- Ø60mm



RUEDA S/S IP66 10V
WITH PIR SENSOR

TANGO BLACK MATT 0,8W

TANGO BLACK MATT 0,8W

WALL LED LIGHT

COLOR (K): White 6000K

▪ **Dimension:** 73x73x10,5mm

▪ Ø60mm



TANGO BLACK MATT 0,8W

TANGO STICK ALUMINIUM 0,8W

TANGO STICK ALUMINIUM 0,8W WALL LED LIGHT

COLOR (K): Warm white

▪ **Dimension:** 73x73mm

▪ Ugradnja na ljepljenje



TANGO STICK ALUMINIUM 0,8W



TANGO MAX ALUMINIUM 1,6W

TANGO MAX ALUMINIUM 1,6W WALL LED LIGHT COLOR (K): Warm white

- **Dimension:** 143X73X10,5mm
- Ugradnja na ljepljenje



TANGO MAX ALUMINIUM 1,6W

TANGO MINI STICK ALUMINIUM 0,4W

TANGO MINI STICK ALUMINIUM 0,4W WALL LED LIGHT COLOR (K): Warm white

TANGO MINI STICK ALUMINIUM 0,4W BLACK WALL LED LIGHT COLOR (K): Warm white

- **Dimension:** 60X60mm
- Ugradnja na ljepljenje



TANGO MINI STICK ALUMINIUM 0,4W



TANGO MINI STICK ALUMINIUM 0,4W BLACK

RUEDA STICK ALUMINIUM 0,8W

TANGO STAINLESS STEEL 0,8W WALL LED LIGHT

- **Dimension:** Ø73mm
- Ugradnja na ljepljenje
- **COLOR (K):** Warm white



RUEDA STICK ALUMINIUM 0,8W



RUEDA MINI STICK ALUMINIUM 0,4W



RUEDA MINI ALUMINIUM STEEL 0,4W

WALL LED LIGHT

- **Dimension:** Ø73mm
- Ugradnja na ljepljenje
- **COLOR (K):** Warm white

RUEDA MINI STICK ALUMINIUM 0,4W

POWER SUPPLY TYPE ZOL 7

POWER SUPPLY TYPE ZOL 7

RATED POWER 7W

- **Dimension:** Ø53X25mm
- Ø60mm



IP44



POWER SUPPLY TYPE ZOL 7

POWER SUPPLY TYPE ZOL 15

POWER SUPPLY TYPE ZOL 7

RATED POWER 15W

- **Dimension:** Ø53X32mm
- Ø60mm



IP44



POWER SUPPLY TYPE ZOL 15

POWER SUPPLY TYPE ZOL 6

POWER SUPPLY TYPE ZOL 7

RATED POWER 6W

- **Dimension:** 93x35x22mm
- IP65



POWER SUPPLY TYPE ZOL 6



RUMBA ALUMINIUM WARM WHITE STICK



RUMBA ALUMINIUM WARM WHITE STICK

RUMBA ALUMINIUM WARM WHITE STICK 0,8W WALL LED LIGHT

- **Dimension:** 150x40mm

BOLERO OL 7 BLACK

BOLERO OL 7 BLACK WARM WHITE 1,8W, 3000K

- **Dimension:** Ø76mm
- Ø60mm 



BOLERO OL 7 BLACK



SALSA SHORT MATT BRASS IP66 0,8W

SALSA SHORT MATT BRASS IP66 0,8W

SALSA SHORT MATT BRASS IP66 0,8W WALL LED LIGHT

- **Dimension:** 73x73mm
- Ø60mm 
- **COLOR (K):** Warm white

SALSA STICK MATT BRASS IP20 0,8W

SALSA STICK MATT BRASS IP20 0,8W WALL LED LIGHT

- **Dimension:** 73x73mm
- Ugradnja na ljepljenje
- **COLOR (K):** Warm white



SALSA STICK MATT BRASS IP20 0,8W



SALSA MAX MATT BRASS IP20 1,6W

SALSA MAX MATT BRASS IP20 1,6W

SALSA MAX MATT BRASS IP20 1,6W WALL LED LIGHT

- **Dimension:** 143x73mm
- Ugradnja na ljepljenje
- **COLOR (K):** Warm white

SD-P001-3WW/3DW

SD-P001-3WW	WHITE	3000K		
SD-P001-3DW	WHITE	4000K		
SD-P001-3WW	BLACK	3000K		
SD-P001-3DW	BLACK	4000K		



SD-P001-3WW/3DW WHITE



SD-P001-3WW/3DW BLACK

- **Dimension:** Ø85x13mm
- Ø68mm
- 3W round led panel light
- CCT: SD-P001-3WW: 3000K
SD-P001-3DW: 4000K
- Lumen: 90-100lm/W
- Beam angle: 120°
- LED chip: Epistar
- Material: aluminium+PC
- 85-265V 50-60Hz



SD-P001-9WW/9DW BLACK



SD-P001-9WW/9DW WHITE





SD-P001-9WW/9DW

SD-P001-9WW	WHITE	3000K		
SD-P001-9DW	WHITE	4000K		
SD-P001-9WW	BLACK	3000K		
SD-P001-9DW	BLACK	4000K		

- **Dimension:** Ø145x13mm
- Ø132mm
- 9W round led panel light
- Lumen: 90-100lm/W
- LED chip: Epistar
- Material: aluminium+PC
- CCT: SD-P001-9WW: 3000K
SD-P001-9DW: 4000K
- Beam angle: 120°
- 85-265V 50-60Hz



SD-P001-18WW/18DW

SD-P001-18WW	WHITE	3000K		
SD-P001-18DW	WHITE	4000K		
SD-P001-18WW	BLACK	3000K		
SD-P001-18DW	BLACK	4000K		



SD-P001-18WW/18DW WHITE



SD-P001-18WW/18DW BLACK

- **Dimension:** Ø220x13mm
- Ø205mm 
- 18W round led panel light
- CCT: SD-P001-18WW: 3000K
SD-P001-18DW: 4000K
- Lumen: 90-100lm/W
- Beam angle: 120°
- LED chip: Epistar
- Material: aluminium+PC
- 85-265V 50-60Hz





SD-P001-24WW/24DW

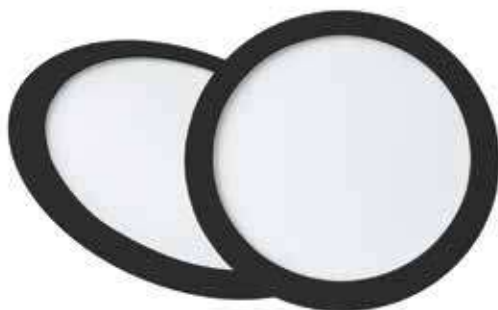

SD-P001-24WW/24DW WHITE



SD-P001-24WW/24DW BLACK

SD-P001-24WW	WHITE	3000K		
SD-P001-24DW	WHITE	4000K		
SD-P001-24WW	BLACK	3000K		
SD-P001-24DW	BLACK	4000K		

- **Dimension:** Ø300x35mm
- Ø280mm 
- 9W round led panel light
- CCT: SD-P001-24WW: 3000K
SD-P001-24DW: 4000K
- Lumen: 90-100lm/W
- Beam angle: 120°
- LED chip: Epistar
- Material: aluminium+PC
- 85-265V 50-60Hz

SD-P002 3WW/3DW

SD-P002-3WW WHITE 3000K



SD-P002-3DW WHITE 4000K



- **Dimension:** 80X80mm
- 72X72mm 
- 3W square led panel light
- CCT: SD-P002-6WW: 3000K
SD-P002-6DW: 4000K
- Lumen: 80-90lm/W
- Beam angle: 120°
- LED chip: Epistar
- Material: aluminium+PC
- 85-265V 50-60Hz



SD-P002-3WW/3DW WHITE



SD-P002 9W/9DW

SD-P002-9WW WHITE 3000K



SD-P002-9DW WHITE 4000K



- **Dimension:** 150x150mm
- 130x130mm 
- 9W square led panel light
- CCT: SD-P002-9WW: 3000K
SD-P002-9DW: 4000K
- Lumen: 80-90lm/W
- Beam angle: 120°
- LED chip: Epistar
- Material: aluminium+PC
- 85-265V 50-60Hz



SD-P002-12WW/12DW WHITE



SD-P002 18WW/18DW

SD-P002-18WW WHITE 3000K



SD-P002-18DW WHITE 4000K



- **Dimension:** 220x220mm
- 200x200mm 
- 18W square led panel light
- CCT: SD-P002-18WW: 3000K
SD-P002-18DW: 4000K
- Lumen: 90-100lm/W
- Beam angle: 120°
- LED chip: Epistar
- Material: aluminium+PC
- 85-265V 50-60Hz



SD-P002-18WW/18DW WHITE

SD-P002 24WW/24DW

SD-P002-24WW WHITE 3000K



SD-P002-24DW WHITE 4000K



- **Dimension:** 300x300mm
- 280x280mm 
- 24W square led panel light
- CCT: SD-P002-24WW: 3000K
SD-P002-24DW: 4000K
- Lumen: 90-100lm/W
- Beam angle: 120°
- LED chip: Epistar
- Material: aluminium+PC
- 85-265V 50-60Hz



SD-P002-24WW/24DW WHITE



SD-P001S-6WW/6DW

SD-P001S-6WW WHITE 3000K



SD-P001S-6DW WHITE 4000K



SD-P001S-6WW/6DW WHITE

▪ **Dimension:** Ø120mm

- 6W surface round panel light
- Lumen: 90-100lm/W
- LED chip: Epistar
- Material: aluminium+PC
- CCT: SD-P001S-6WW: 3000K
SD-P001S-6DW: 4000K
- Beam angle: 120°
- 85-265V 50-60Hz

SD-P001S-12WW/12DW



SD-P001S-12WW/12DW WHITE

SD-P001S-12WW WHITE 3000K



SD-P001S-12DW WHITE 4000K



▪ **Dimension:** Ø180mm

- 12W surface round panel light
- Lumen: 90-100lm/W
- LED chip: Epistar
- Material: aluminium+PC
- CCT: SD-P001S-12WW: 3000K
SD-P001S-12DW: 4000K
- Beam angle: 120°
- 85-265V 50-60Hz

SD-P001S-18WW/18DW

SD-P001S-18WW WHITE 3000K



SD-P001S-18DW WHITE 4000K



SD-P001S-18WW BLACK 3000K



SD-P001S-18DW BLACK 4000K



SD-P001S-18WW/18DW WHITE



SD-P001S-18WW/18DW BLACK

▪ **Dimension:** Ø240mm

- 18W surface round panel light
- Lumen: 90-100lm/W
- LED chip: Epistar
- Material: aluminium+PC
- CCT: SD-P001S-18WW: 3000K
SD-P001S-18DW: 4000K
- Beam angle: 120°
- 85-265V 50-60Hz

SD-P001S-24WW/24DW

SD-P001S-24WW	WHITE	3000K		
SD-P001S-24DW	WHITE	4000K		
SD-P001S-24WW	BLACK	3000K		
SD-P001S-24DW	BLACK	4000K		

- **Dimension:** Ø300mm
- 24W surface round panel light
- Lumen: 90-100lm/W
- LED chip: Epistar
- Material: aluminium+PC
- CCT: SD-P001S-24WW: 3000K
SD-P001S-24DW: 4000K
- Beam angle: 120°
- 85-265V 50-60Hz



SD-P001S-24WW/24DW WHITE



SD-P001S-24WW/24DW BLACK

SD-P002S-6WW/6DW

SD-P002S-6WW	WHITE	3000K		
SD-P002S-6DW	WHITE	4000K		

- **Dimension:** 120x120mm
- 6W surface square panel light
- Lumen: 90-100lm/W
- LED chip: Epistar
- Material: aluminium+PC
- CCT: SD-P002S-6WW: 3000K
SD-P002S-6DW: 4000K
- Beam angle: 120°
- 85-265V 50-60Hz



SD-P001S-6WW/6DW WHITE

SD-P002S-12WW/12DW

SD-P002S-6WW	WHITE	3000K		
SD-P002S-6DW	WHITE	4000K		

- **Dimension:** 180x180mm
- 12W surface square panel light
- Lumen: 90-100lm/W
- LED chip: Epistar
- Material: aluminium+PC
- CCT: SD-P002S-12WW: 3000K
SD-P002S-12DW: 4000K
- Beam angle: 120°
- 85-265V 50-60Hz



SD-P002S-12WW/12DW WHITE

SD-P002S-18WW/18DW

SD-P002-18WW WHITE 3000K



SD-P002S-18DW WHITE 4000K



SD-P002S-18WW/18DW WHITE

▪ **Dimension:** 240x240mm

- 18W surface square panel light
- Lumen: 90-100lm/W
- LED chip: Epistar
- Material: aluminium+PC
- CCT: SD-P002S-18WW: 3000K
SD-P002S-18DW: 4000K
- Beam angle: 120°
- 85-265V 50-60Hz

SD-P002S-24WW/24DW

SD-P002-24WW WHITE 3000K



SD-P002S-24DW WHITE 4000K



SD-P002S-24WW/24DW WHITE

▪ **Dimension:** 300x300mm

- 24W surface square panel light
- Lumen: 90-100lm/W
- LED chip: Epistar
- Material: aluminium+PC
- CCT: SD-P002S-24WW: 3000K
SD-P002S-24DW: 4000K
- Beam angle: 120°
- 85-265V 50-60Hz



SD-P001N-3WW/3DW



SD-P001N-3WW/3DW

SD-P001N-3WW WHITE 3000K



SD-P001N-3DW WHITE 4000K



- 3W round led panel light
- Lumen: 90-100lm/W
- LED chip: Epistar
- Material: aluminium+PC
- CCT: SD-P001N-3WW: 3000K
SD-P001N-3DW: 4000K
- Beam angle: 120°
- 85-265V 50-60Hz

- **Dimension:** Ø85x13mm
- Ø68mm 



SD-P001N-9WW/9DW

SD-P001N-9WW/9DW

SD-P001N-9WW WHITE 3000K



SD-P001N-9DW WHITE 4000K



- **Dimension:** Ø145x13mm
- Ø130mm 
- 9W round led panel light
- Lumen: 90-100lm/W
- LED chip: Epistar
- Material: aluminium+PC
- CCT: SD-P001N-9WW: 3000K
SD-P001N-9DW: 4000K
- Beam angle: 120°
- 85-265V 50-60Hz

SD-P001N-18WW/18DW

SD-P001N-18WW WHITE 3000K



SD-P001N-18DW WHITE 4000K



- **Dimension:** Ø220x13mm
- Ø205mm 
- 18W round led panel light
- Lumen: 90-100lm/W
- LED chip: Epistar
- Material: aluminium+PC
- CCT: SD-P001N-18WW: 3000K
SD-P001N-18DW: 4000K
- Beam angle: 120°
- 85-265V 50-60Hz



SD-P001N-18WW/18DW

SD-P001N-24WW/24DW

SD-P001N-24WW WHITE 3000K



SD-P001N-24DW WHITE 4000K





- **Dimension:** Ø300x35mm
- Ø280mm 
- 24W round led panel light
- Lumen: 90-100lm/W
- LED chip: Epistar
- Material: aluminium+PC
- CCT: SD-P001N-24WW: 3000K
SD-P001N-24DW: 4000K
- Beam angle: 120°
- 85-265V 50-60Hz



SD-P001N-24WW/24DW

LED PANEL SLIM 600x600

LED-P1-6060-230V-50Hz-40W-ST-IP20-3000K-3600lm 

LED-P1-6060-230V-50Hz-40W-ST-IP20-4000K-3600lm 

LED-P1-6060-230V-50Hz-40W-ST-IP20-4000K-5200lm 

LED-P1-6060-230V-50Hz-40W-ST-IP20-6500K-3600lm 



LED PANEL SLIM 600x600



PANEL PLASTER MOUNTING
4 PCS SPRING/SET



PANEL PENDANT INSTALLATION
4 LINE/SET



PANEL SURFACE MOUNTING
WHITE FRAME

LED PANEL SLIM 300x1200

LED-P1-30120-230V-50Hz-40W-ST-IP20-3000K-3600lm 

LED-P1-30120-230V-50Hz-40W-ST-IP20-4000K-3600lm 

LED-P1-30120-230V-50Hz-40W-ST-IP20-4000K-5200lm 

LED-P1-30120-230V-50Hz-40W-ST-IP20-6500K-3600lm 



LED PANEL SLIM 300x1200



PANEL PLASTER MOUNTING
4 PCS SPRING/SET



PANEL PENDANT INSTALLATION
4 LINE/SET



PANEL SURFACE MOUNTING
WHITE FRAME



- 1x18W, 2x18W
- 1x36W, 2x36W
- 1x58W, 2x58W



0 1x18W	662x81x93mm
0 2x18W	662x130x93mm
0 1x36W	1270x81x93mm
0 2x36W	1270x130x93mm
0 1x58W	1562x81x93mm
0 2x58W	1562x130x93mm



▪ Kućište je namijenjeno isključivo led cijevima s priključnim kontaktima na jednoj strani!

TH-HB-240A UFO

TH-HB-240A UFO

200W/240W

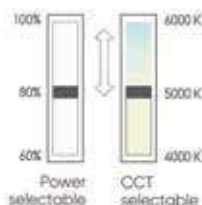
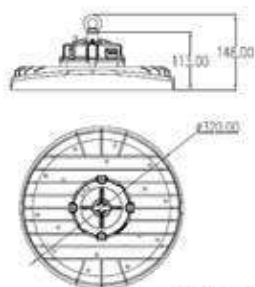

Product Specifications:

SKU	TH-HB-240C
Watts	240W
Initial Luminous Flux	36000 lm
Luminous Efficiency	Single: 150lm/w 2 in 1: 170lm/w
Power Factor	>0.95
Input Voltage	100-240 VAC
CCT	3000K-6500K
CRI	≥70
Beam Angle	90°
Housing Color	Black
Housing Material	Aluminium, PC & Glass
Working Environment	-30°C to +50° 10% to 90% R
Lifespan	>50000 hrs



LED BATTEN

G **A T G** **LED BATTEN 60cm** 18W, 1500lm

- **Dimension:** 600x75x25,5mm

F **A T G** **LED BATTEN 90cm** 27W, 2300lm

- **Dimension:** 900x75x25,5mm

G **A T G** **LED BATTEN 120cm** 36W, 3000lm

- **Dimension:** 1200x75x25,5mm

- CRI (Ra): 80
- Color Temp.: 4000K
- Beam Angle: 120°
- Input: AC100-240V
- IP: 20
- Hz: 50
- PF: 0.9



LED BATTEN

LED BATTEN UL05M IP44

UL05M-H-12 40W, 4800lm, 5 years warranty



- **Dimension:** 1200x72x72,5mm

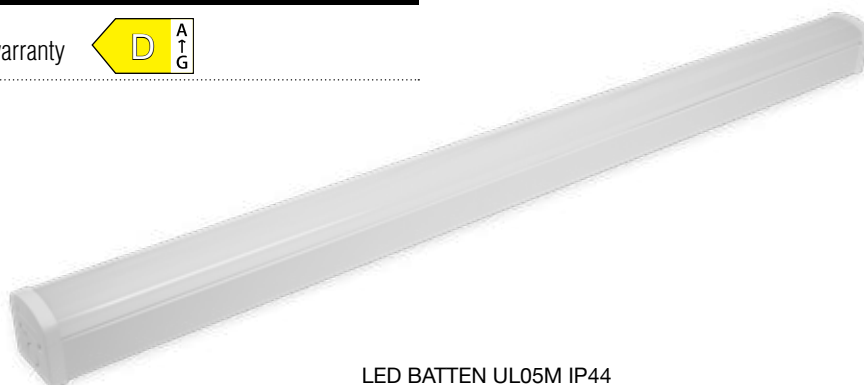

LED BATTEN UL05M IP44



LED BATTEN LAMP

LED BATTEN-004-0.6m AC220-240V, 18W, 4000K, 1440lm, IP65



- **Dimension:** 65x75x600mm



LED BATTEN LAMP

LED UL08M

LED UL08M 12 AC220-240V, 36W, 4320lm, 3CCT (3000K-4000K-6500K), IP65, LINKABLE 2*0.75, Dim: 1202x48x60mm



LED UL08M 15 AC220-240V, 50W, 4320lm, 3CCT (3000K-4000K-6500K), IP65, LINKABLE 2*0.75, Dim: 1502x48x60mm



LED UL08M

LED T5 KONEKTIBILNE



LED T5 300 VODIČ SA UTIKAČEM AC220-240V, 4W, 4000K, 440lm, Dim: 313 mm



LED T5 600 VODIČ SA UTIKAČEM AC220-240V, 8W, 4000K, 880lm, Dim: 573 mm



LED T5 900 VODIČ SA UTIKAČEM AC220-240V, 10W, 4000K, 1100lm, Dim: 873 mm



LED T5 1200 VODIČ SA UTIKAČEM AC220-240V, 14W, 4000K, 1540lm, Dim: 1173 mm



LED T5 300

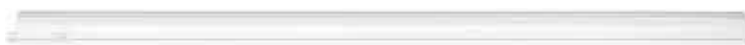

LED T5 600



LED T5 900



LED T5 1200

ARMATURA BAKELIT

ARMATURA BAKELIT RAVNA

ARMATURA BAKELIT KOSA



ARMATURA BAKELIT RAVNA



ARMATURA BAKELIT KOSA



6303 OPAL

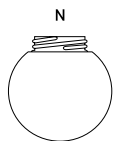

6303 OPAL

6303 OPAL Ø150mm, h=152mm, N=84,5mm

GRLO DR171

GRLO DR171 G5.3



GRLO DR171

GRLO DR281

GRLO DR281 GU10



GRLO DR281

GX10 LAMPHOLDER

GX10 LAMPHOLDER



GX10 LAMPHOLDER

LA2402 GX53

LA2402 GX53 LAMPHOLDER



LA2402 GX53 LAMPHOLDER

GRLO CP805/800F

GRLO CP 805 E-27

GRLO CP 800F E-27



GRLO CP805



GRLO CP800F

ES-G06

ES.G06 LUXOMAT 15A MAX



ES-G06

ST127B

ST127B 12-24V/DC, MAX 60W

- **Dimension:** Ø50x6.3mm
- TOUCH DIMMING SENSOR, IT'S ON OR OFF IS CONTROLLED BY TOUCHING
- DIMMING RANGE: 10%-100%
- WOOD/GLASS THICKNESS: ≤40mm

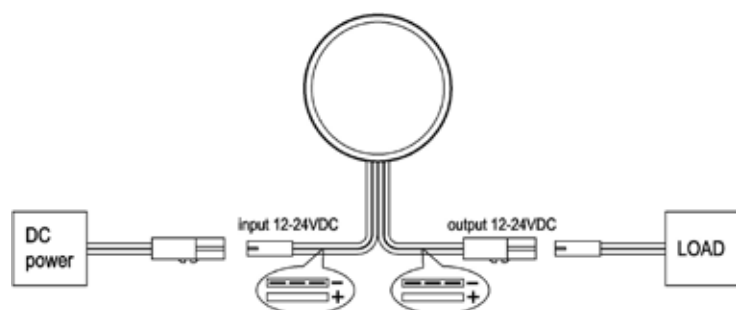

ST127B

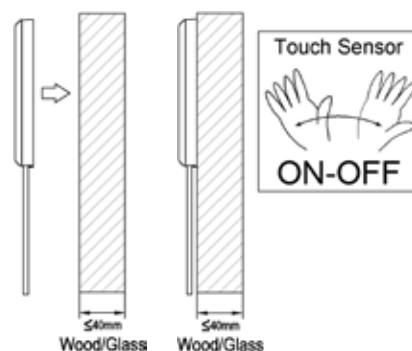

ST701D WHITE

ST701D WHITE SENZOR

- Power Source: 220-240V/AC
- Frequency: 50/60Hz
- Ambient Light: >3-2000LUX (adjustable)
- Time Delay: Min. 10sec±3sec, Max. 12min±1min
- Rated load: Max. 1200W
300W
- Detection Range: 360°
- Detection Distance: 1-8m (radius) adjust.
- HF System: 5.8GHz CW radar, ISM band
- Transmission Power: <
- Power Consumption: approx 0.9W
- Installation Height: 2-6m
- Detection Moving Speed: 0.6-1.5m/s



ST701D WHITE

ST122 IP20

ST122 IP20 SENZOR HAND

- Power Source: 220-240V/AC
- Power Frequency: 50/60Hz
- Rated Current: 5A
- Detection Distance: 5-6cm
- Rated Load: Max. 500W
200W
- Working Temperature: -20~+50°C



ST122 IP20

PD-PIR 118 IP20

PD-PIR 118 IP20 SENZOR MODULARNI

- Power Source: 220-240V/AC
- Power Frequency: 50Hz
- Rated load: Max. 800W Max. tungsten
200W Max. fluorescent
- Detection Range: <7m (22°C)
- Time setting: Min. 9sec±2sec
Max: 3min±30sec (adjustable)
- Detection angle: 120°
- Light control: 10LUX~sunshine (adjustable)
- Working Temperature: -20~+40°C
- Working Humidity: <93%RH
- Power Consumption: approx 0.5W
- Installation Height: 1.5-2.5m



PD-PIR 118 IP20

ST15 IP65 WH/BL

ST15 IP65 WH SENZOR POKRETA

ST15 IP65 BL SENZOR POKRETA

- Power Source: 220-240V/AC
- Power Frequency: 50/60Hz
- Ambient Light: >3-2000LUX (adjustable)
- Time Delay: Min. 10sec±3sec, Max. 15min±2min
- Rated load: Max. 1200W
300W
- Detection Range: 180°
- Detection Distance: 12m max (>24°C)
- Working Temperature: -20~+40°C
- Working Humidity: <93%RH
- Power Consumption: approx 0.5W
- Installation Height: 1.8-2.5m
- Detection Moving Speed: 0.6-1.5m/s



ST15 IP65 WH



ST15 IP65 BL

ST40 IP20

ST40 IP20 SENZOR UGRADNI STROPNI

- Power Source: 220-240V/AC
- Power Frequency: 50/60Hz
- Ambient Light: >3-2000LUX (adjustable)
- Time Delay: Min. 10sec±3sec, Max. 15min±2min
- Rated load: Max. 800W
400W
- Detection Range: 360°
- Detection Distance: 6m max (>24°C)
- Working Temperature: -20~+40°C
- Working Humidity: <93%RH
- Power Consumption: approx 0.5W
- Installation Height: 2.2-4m
- Detection Moving Speed: 0.6-1.5m/s



ST40 IP20

ST05C WHITE

ST05C WHITE SENZOR POKRETA

- Power Source: 220-240V/AC
- Power Frequency: 50/60Hz
- Ambient Light: >3-2000LUX (adjustable)
- Time Delay: Min. 10sec±3sec, Max. 15min±2min
- Rated load: Max. 800W
400W
- Detection Range: 360°
- Detection Distance: 6m max (>24°C)
- Working Temperature: -20~+40°C
- Working Humidity: <93%RH
- Power Consumption: approx 0.5W
- Installation Height: 2.2-4m
- Detection Moving Speed: 0.6-1.5m/s



ST05C

ST78-5 E27

ST78-5 PLAFONJERA SA SENZOROM E27, 2x40W, IP20

- Power Source: 220-240V/AC
- Power Frequency: 50Hz
- Ambient light: <3-2000LUX (adjustable)
Time delay: Min. 10sec±3sec
Max: 3min±30 sec
- Rated load: Max 2x40W (E27)
- Detection Range: 360°
- Detection distance: max. 6m (<24°C)
- Working temperature: -20~+40°C
- Working humidity: <93%RH
- Installation height: 2.2-4m
Detection moving speed: 0.6-1.5m/s



ST78-5 E27

ST77A LED 12W

ST77A LED PLAFONJERA SA SENZOROM 12W

- Power Source: 110-240V/AC
- Power Frequency: 50/60Hz
- Ambient light: <3-2000LUX (adjustable)
- Time delay: Min. 10sec±3sec
Max: 3min±30 sec
- Rated load: 12W (800lm)
- Detection Range: 360°
- Detection distance: max. 6m (<24°C)
- Working temperature: -20~+40°C
- Working humidity: <93%RH
- Installation height: 2.2-4m
Detection moving speed: 0.6-1.5m/s



ST77A LED 12W

ST77AE LED 12W PANIK

ST77AE LED PLAFONJERA SA SENZOROM 12W PANIK

- Power Source: 110-240V/AC
- Power Frequency: 50/60Hz
- Ambient light: <3-2000LUX (adjustable)
- Time delay: Min. 10sec±3sec
Max: 3min±30 sec
- Rated load: 12W (800lm)
- Emergency Load: 1.2W (DC) (65lm)
- Detection Range: 360°
- Detection distance: max. 6m (<24°C)
- Working temperature: -20~+40°C
- Working humidity: <93%RH
- Installation height: 2.2-4m
- Battery: 3.7V/1500mAh lithium battery
- Detection Motion Speed: 0.6-1.5m/s
- Continuous illumination time: 5hours (when the battery power supply)



ST77AE LED 12W PANIK

ST706 K



ST706K

ST706K MICROWAVE LED SENSOR LAMP



- Power Source: 220-240V/AC
- Power Frequency: 50/60Hz
- Ambient light: <3-2000LUX (adjustable)
- Time delay: Min. 10sec±3sec
Max: 12min±1min
- Rated load: 12W (800LM)
- Detection Motion Speed: 0,6-1,5m/s
- Detection Range: 180°/360°
- Detection distance: wall: 5-15m (adjustable); ceiling: 2-8m (radius) adjustable
- HF System: 5.8GHz CW radar, ISM band
- Transmission power: <0.2m/W
- Installation height: wall: 1,5-3,5m; ceiling: 2-4m
- Power consumption: approx 0.9W
- Detection Motion Speed: 0.6-1.5m/s

PD-IN2061 IP20

PD-IN2061

PLAFONJERA SA SENZOROM

IP20

- Power Source: 220-240V/AC
- Power Frequency: 50Hz
- Transmission power: 1m/W
- Rated load: 2x40W E27 (max 5A)
Protection level: IP20
- Detection angle: 360°
- Detection range: 2-10m (radius), adjustable
- Ambient light: <3-2000LUX (adjustable)
- Time setting: 8sec-12min (adjustable)
- Light control: 20LUX-daylight (adjustable)
- Installation sit: indoors, ceiling mounting



PD-IN2061

ST56B

ST56B

INFRARED LED SENSOR LAMP



- Power Source: 220-240V/AC
- Power Frequency: 50/60Hz
- Ambient Light: >3-2000LUX (adjustable)
- Time Delay: Min. 10sec±3sec, Max. 5min±1min
- Rated Load: Max. 15W (1100LM)
- Detection Range: 140°
- IP CLASS: IP65
- Detection Distance: 9m max (>24°C)
- Working Temperature: -20~+40°C
- Working Humidity: <93%RH
- Power Consumption: approx 0.5W
- Installation Height: 1.8-2.5m
- Detection Moving Speed: 0.6-1.5m/s



ST56B

LED-CL8



LED-CL8 ROUND



LED-CL8 SQUARE

LED-CL8-D220-AC220-240V-12W-4000K-1080Lm-ROUND-IP44

- Dimension: $\varnothing 220 \times 42 \text{mm}$



LED-CL8-D280-AC220-240V-18W-4000K-1500Lm-ROUND-IP44

- Dimension: $\varnothing 280 \times 42 \text{mm}$



LED-CL8-D330-AC220-240V-30W-4000K-2700Lm-ROUND-IP44

- Dimension: $\varnothing 330 \times 42 \text{mm}$



LED-CL8-D220-AC220-240V-12W-4000K-1080Lm-SQUARE-IP44

- Dimension: $220 \times 220 \times 42 \text{mm}$



LED-CL8-D280-AC220-240V-18W-4000K-1620Lm-SQUARE-IP44

- Dimension: $280 \times 280 \times 42 \text{mm}$



LED-EME-507L50

LED-EME-507L50 4.4W, 400lm, IP65

PRIBOR ZA UGRADNJU 507

PRIBOR ZA OVJESNI PIKTOGRAM 507

NALJEPNICA SMJERA 507



LED-EME-507L50



PRIBOR ZA UGRADNJU



PRIBOR ZA OVJESNI PIKTOGRAM

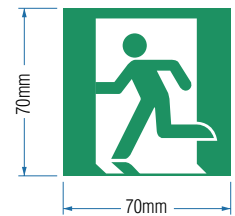
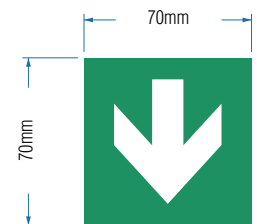

NALJEPNICA

LED-EME-2917

LED-EME-2917 AC220-240V, 4W, 4000K, 10lm, IP20, maintained arrow left/right-side/wall mounting accessory, 292x181x41.5mm

HANG MOUNTING ACCESSORY FOR 2917

REPLACEABLE PICTOGRAM FOR 2917 - ARROW DOWN

EXIT SIGN STICKER



LED-EME-2917

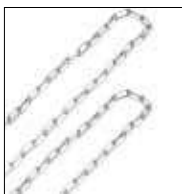

HANG MOUNTING ACCESSORY



REPLACEABLE PICTOGRAM



EXIT SIGN STICKER

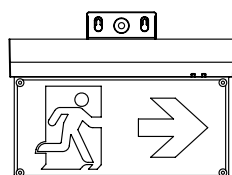

WALL MOUNTING

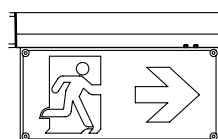

SIDE MOUNTING

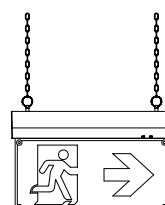

HANG MOUNTING

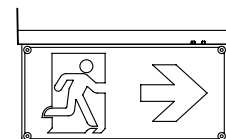

CEILING MOUNTING

HERMIT CRAB

HERMIT CRAB HC3M3528-32 SIVA PANIK LED

- Rated voltage: 220-240V~50Hz
- Power: 0.6W
- LED: SMD3528
- Mode of operation: Maintained
- Duration: 3h
- Battery: Ni-Mh 80mAh 3.6V
- NW(g): 52

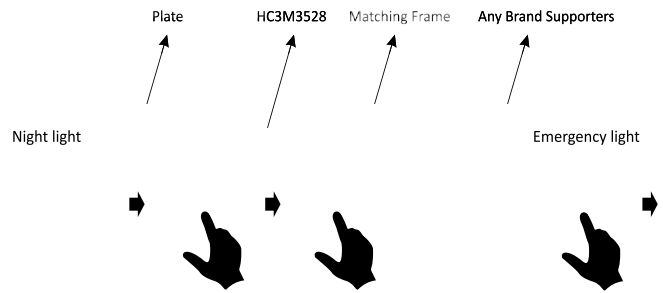

FAT-LED-F1B

FAT-LED-F1B EMERGENCY KIT

- **Dimension:** 250x40x28mm
- AC85-265V
- 18650 Li-ion 11.7V
- 2400mAh
- 3-20W
- 120-60 mins



SMART LED

EKL0901 LED EMERGENCY KIT Duration: 1h, NW(g): 440

EKL0903 LED EMERGENCY KIT Duration: 3h, NW(g): 1040

- Rated voltage: 220-240V
- Mode of operation: Maintained
- Power: Max. 9W
- Battery: Ni-CD 1200mAh 9.6V (**EKL0901**)
Ni-CD 3500mAh 9.6V (**EKL0903**)

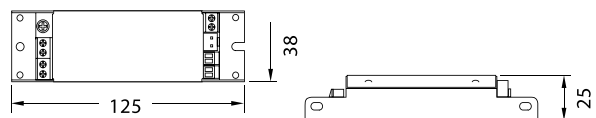
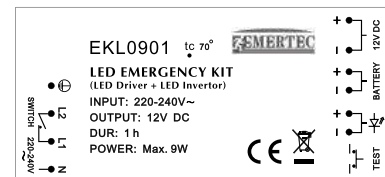
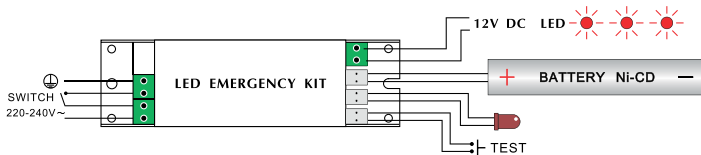

LT-49201 EMERGENCY

LT-49201 EMERGENCY 3W LED 3.7V 2000mAh Li-ion battery, With test button and auto-test function, Emergency >3hours, both surface and recessed installation, anti-fire plastic, with CB and CE, IP20

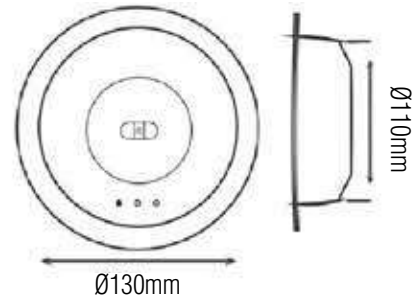

LT-49201 EMERGENCY

SEC-L-EL124 EMERGENCY

SEC-L-EL124 EMERGENCY KIT FOR LED PANELS Input:220-240V, Output:DC9-75V, Emergency power:2W, with LiFePO4 battery inside, 3hrs



SEC-L-EL124 EMERGENCY KIT FOR LED PANELS

ST-G130MRA

ST-G130MRA E27, G130 LED filament horizontal ring in the middle amber, 4W, 2700K, dimmable

▪ **Dimension:** $\varnothing=130\text{mm}$ $v=164\text{mm}$



ST-G130MRA



ST-G125TRA

ST-G125TRA

ST-G125TRA E27, G125 LED filament bottom ring amber, 4W, 2700K, dimmable

▪ **Dimension:** $\varnothing=125\text{mm}$ $v=152\text{mm}$



ST-G130UFOA

ST-G130UFOA E27, G130 UFO glass amber middle ring, 4W, 2700K, dimmable



▪ **Dimension:** $\varnothing=121\text{mm}$ $v=129\text{mm}$



ST-G130UFOA



LF-L500ESCL

LF-L500ESCL 500mm linear LED filament, rotated E27 socket, clear glass, 6W, 2700K, dimmable



- **Dimension:** $\varnothing=500\text{mm}$ $v=72\text{mm}$



LF-L500ESCL

LF-L500ESA

LF-L500ESA 500mm linear LED filament, rotated E27 socket, amber glass, 6W, 2500K, dimmable



- **Dimension:** $\varnothing=500\text{mm}$ $v=72\text{mm}$



LF-L500ESA





C35TSF

C35TSF

C35TSF E14, candle amber super fine soft LED filament 0.6mm thickness, 3W, 2700K, dimmable no flicker



- **Dimension:** $\varnothing=35\text{mm}$ $v=98\text{mm}$

T45TSF

T45TSF E27, T45 amber super fine soft LED filament 0.6mm thickness, 4W, 2700K, dimmable no flicker



- **Dimension:** $\varnothing=45\text{mm}$ $v=115\text{mm}$



T45TSF

A60TSF

A60TSF E27, A60 amber super fine soft LED filament 0.6mm thickness, 4W, 2700K, dimmable no flicker

- **Dimension:** $\varnothing=60\text{mm}$ $v=106\text{mm}$



A60TSF



ST64TSF

ST64TSF E27, ST64 amber super fine soft LED filament 0.6mm thickness, 6W, 2700K, dimmable no flicker

- **Dimension:** $\varnothing=64\text{mm}$ $v=144\text{mm}$



ST64TSF



T30TSF

T30TSF

T30TSF E27, T30 amber super fine soft LED filament 0.6mm thickness, 4W, 2700K, dimmable no flicker



- **Dimension:** $\varnothing=30\text{mm}$ $v=185\text{mm}$

A60

A60 CLEAR LED filament bulb, E27, AC220-240V, 6W, 2700K, 720lm



A60 GOLDEN LED filament bulb, E27, AC220-240V, 6W, 2700K, 720lm



A60 GOLDEN LED filament bulb, E27, AC220-240V, 6W, 2700K, 720lm, DIMMABLE



A60 SMOKY LED filament bulb, E27, AC220-240V, 6W, 2700K, 720lm



A60 CLEAR LED filament bulb, E27, AC220-240V, 10W, 3000K



A60 CLEAR LED filament bulb, E27, AC220-240V, 10W, 4000K



A60 SMOKY



A60 GOLDEN



A60 CLEAR

G45

G45 CLEAR LED filament bulb, E27, AC220-240V, 4W, 2700K, 470lm, DIMMABLE



G45 GOLDEN LED filament bulb, E27, AC220-240V, 4W, 2700K, 470lm, DIMMABLE



G45 CLEAR



G45 GOLDEN

C35

C35 AMBER LED filament bulb, E14, AC220-240V, 4W, 2700K, 470lm



C35 CLEAR LED filament bulb, E14, AC220-240V, 4W, 2700K, 470lm, DIMMABLE



C35 GOLDEN LED filament bulb, E14, AC220-240V, 4W, 2700K, 470lm, DIMMABLE



C35 AMBER



C35 CLEAR



C35 GOLDEN

G125

G125 GOLDEN LED filament bulb, E27, AC220-240V, 6W, 2700K, 720lm

G125 GOLDEN LED filament bulb, E27, AC220-240V, 6W, 2700K, 720lm, DIMMABLE

G125 SMOKY LED filament bulb, E27, AC220-240V, 6W, 2700K, 720lm



G125 GOLDEN



G125 SMOKY

ST64

ST64 GOLDEN LED filament bulb, E27, AC220-240V, 6W, 2700K, 720lm, DIMMABLE

ST64 SMOKY LED filament bulb, E27, AC220-240V, 6W, 2700K, 720lm

ST64 GOLDEN LED filament bulb, E27, AC220-240V, 6W, 2700K, 810lm



ST64 GOLDEN



ST64 SMOKY

T25X85

T25X85 GOLDEN LED filament bulb, E14, AC220-240V, 4W, 2700K, 470lm

T25X85 CLEAR LED filament bulb, E14, AC220-240V, 4W, 2700K, 470lm



T25X85 CLEAR



T25X85 GOLDEN

BT75

BT75 E27, 220-240V, 6W, 2000-2200K LONG FILAMENT



BT75 LONG FILAMENT

A60

A60 LED A60, E27, AC220-240V, 9W, 3000K, 820lm, 60x108mm



A60 LED A60, E27, AC220-240V, 9W, 4000K, 820lm, 60x108mm



A60 LED A60, E27, AC220-240V, 9W, 3000K, 820lm, 60x108mm, DIMMABLE



A60 LED A60, E27, AC220-240V, 9W, 4000K, 820lm, 60x108mm, DIMMABLE



A60 LED A60, E27, AC220-240V, 12W, 3000K, 1200lm, 60x110mm



A60 LED A60, E27, AC220-240V, 12W, 4000K, 1200lm, 60x110mm



A60 LED A60, E27, AC220-240V, 15W, 3000K, 1500lm, 60x120mm



A60 LED A60, E27, AC220-240V, 15W, 4000K, 1500lm, 60x120mm



A60

C37

C37 LED C37, E14, AC220-240V, 5W, 3000K, 430lm, 37x100mm



C37 LED C37, E14, AC220-240V, 5W, 4000K, 430lm, 37x100mm



C37 LED SL E14, C37, 5W-WW, 3000K,400lm, 37x100mm, DIMMABLE



C37 LED SL E14, C37, 5W-NW, 4000K,400lm, 37x100mm, DIMMABLE



C37



G45

G45

G45 LED G45, E14, AC220-240V, 5W, 3000K, 430lm, 45x78mm



G45 LED G45, E14, AC220-240V, 5W, 4000K, 430lm, 45x78mm



G95

G95 LED G95, E27, AC220-240V, 15W, 3000K, 1500lm, 95x135mm



G95 LED G95, E27, AC220-240V, 15W, 4000K, 1500lm, 95x135mm



G95



G120

G120











G120 LED G120, E27, AC220-240V, 18W, 3000K, 1820lm, 120x160mm



G120 LED G120, E27, AC220-240V, 18W, 4000K, 1820lm, 120x160mm











GU10 38°

GU10	LED GU10, AC220-240V, 5W, 3000K, 425lm, 38°, 50x57mm		
GU10	LED GU10, AC220-240V, 5W, 3000K, 425lm, 38°, 50x57mm, DIMMABLE		
GU10	LED GU10, AC220-240V, 5W, 4000K, 425lm, 38°, 50x57mm		
GU10	LED GU10, AC220-240V, 5W, 4000K, 425lm, 38°, 50x57mm, DIMMABLE		
GU10	LED GU10, AC220-240V, 5W, 6500K, 425lm, 38°, 50x57mm, DIMMABLE		



GU10 38°

GU10 120°

GU10	LED GU10, AC220-240V, 5W, 3000K, 425lm, 120°, 50x57mm		
GU10	LED GU10, AC220-240V, 5W, 4000K, 425lm, 120°, 50x57mm		
GU10	LED GU10, AC220-240V, 5W, 6500K, 425lm, 120°, 50x57mm		
GU10	LED GU10, AC220-240V, 7W, 3000K, 600lm, 120°, 50x57mm, DIMMABLE		
GU10	LED GU10, AC220-240V, 7W, 4000K, 600lm, 120°, 50x57mm, DIMMABLE		
GU10	LED GU10, AC220-240V, 8W, 3000K, 720lm, 120°, 50x57mm		
GU10	LED GU10, AC220-240V, 8W, 4000K, 720lm, 120°, 50x57mm		



GU10 120°



MR16

MR16

MR16 LED MR16 GU5.3, AC220-240V, 5W, 3000K, 400lm, 38°, 50x50mm



MR16 LED MR16 GU5.3, AC220-240V, 5W, 4000K, 400lm, 38°, 50x50mm



MR11

MR11 LED MR11, 3W, 38°, 300lm, 3000K, 35x47mm



MR11 LED MR11, 3W, 38°, 300lm, 4000K, 35x47mm



MR11

E27

E27 LED E27, A3.5W, 300lm, 3000K, 100°



E27 LED E27, A3.5W, 300lm, 4000K, 100°



E27



SG-TH7W CCT

SG-TH7W CCT

SG-TH7W CCT without ring, 7w, 560lm, 230V, 2x0.5mm with terminal block



SL-SMD-AR111-GU10





SL-SMD-AR111-GU10 12W AL.	12LED AC230V, 45°, 900lm, 3000K, DIMMABLE		
SL-SMD-AR111-GU10 12W AL.	12LED AC230V, 45°, 900lm, 4000K, DIMMABLE		
SL-SMD-AR111-GU10 12W AL.	12LED AC230V, 45°, 900lm, 6000K, DIMMABLE		
SL-SMD-AR111-GU10 12W AL.	12LED AC85-265V, 45°, 950lm, 3000K		
SL-SMD-AR111-GU10 12W AL.	12LED AC85-265V, 45°, 950lm, 4000K		
SL-SMD-AR111-GU10 12W AL.	12LED AC85-265V, 45°, 950lm, 6000K		

▪ **Dimension:** 110*110*75mm ▪ **Material:** Aluminium



SL-SMD-AR111-GU10









SL-PC-G4H

SL-PC-G4H	2W, AC/DC12V, 12PCS 2835, 2800-3000K		
SL-PC-G4H	2W, AC/DC12V, 12PCS 2835, 4000K		



SL-PC-G4H

SL-PC-G9HD

SL-PC-G9HD	3W, 230V, DIMMABLE 14PCS 2835, 2800-3000K		
SL-PC-G9HD	3W, 230V, DIMMABLE 14PCS 2835, 4000-4500K		
SL-PC-G9HD	5W, 230V, DIMMABLE 24PCS 2835, 2800-3000K		
SL-PC-G9HD	5W, 230V, DIMMABLE 24PCS 2835, 4000-4500K		



SL-PC-G9HD

LED TUBE T8

LED TUBE T8 0,6m 9W 4000K, 180-265V, PF0,9, DF0,9, CRI>80, BEAM ANGLE 240 140lm, WARRANTY 3YRS

LED TUBE T8 0,6m 9W 6500K, 180-265V, PF0,9, DF0,9, CRI>80, BEAM ANGLE 240 140lm, WARRANTY 3YRS

LED TUBE T8 1,2m 18W 4000K, 180-265V, PF0,9, DF0,9, CRI>80, BEAM ANGLE 240 140lm, WARRANTY 3YRS

LED TUBE T8 1,2m 18W 6500K, 180-265V, PF0,9, DF0,9, CRI>80, BEAM ANGLE 240 140lm, WARRANTY 3YRS

LED TUBE T8 1,5m 23W 4000K, 180-265V, PF0,9, DF0,9, CRI>80, BEAM ANGLE 240 140lm, WARRANTY 3YRS

LED TUBE T8 1,5m 23W 6500K, 180-265V, PF0,9, DF0,9, CRI>80, BEAM ANGLE 240 140lm, WARRANTY 3YRS



LED TUBE T8 0,6m



LED TUBE T8 1,2m



LED TUBE T8 1,5m



APL-002

APL-002 RA HALOGENA UGRADBENA MR16, IP20

APL-002 SK HALOGENA UGRADBENA MR16, IP20

▪ **Dimension:**

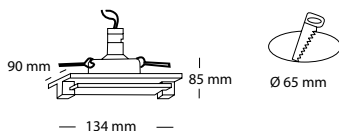

APL-002 RA



APL-002 SK

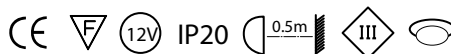

CRY-02S

CRY02S HALOGENA UGRADBENA MR16 (GU10)



▪ **Dimension:**

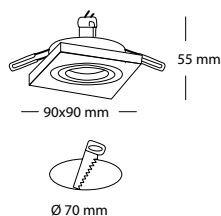

CRY-02S

DG-100, DGS-100

DG-100 HALOGENA UGRADBENA MR16 (GU10)

DGS-100 HALOGENA UGRADBENA MR16 (GU10)

▪ **Dimension:**

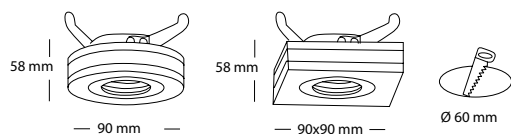

DG-100



DGS-100



ELC-144

ELC-144 WH HALOGENA UGRADBENA MR16 (GU10)

ELC-144 CH HALOGENA UGRADBENA MR16 (GU10)

ELC-144 NM HALOGENA UGRADBENA MR16 (GU10)

▪ **Dimension:** 75x75mm

▪ Ø62mm



ELC-144 WH



ELC-144 CH



ELC-144 NM



ELC-429

ELC-429 WH HALOGENA UGRADBENA MR16 (GU10)

ELC-429 CH HALOGENA UGRADBENA MR16 (GU10)

ELC-429 NM HALOGENA UGRADBENA MR16 (GU10)

▪ **Dimension:** 82x82mm ▪ Ø75mm 



ELC-429 CH



ELC-429 WH



ELC-429 NM

CE  12V IP20  0.5m 



ELC-104(3053) WH

ELC-104 (3053) GM

ELC-104 (3053) PB

CE  12V IP20  0.5m 

ELC-104 (3053)

ELC-104 WH (3053) HALOGENA UGRADBENA MR16 (GU10)

ELC-104 PB (3053) HALOGENA UGRADBENA MR16 (GU10)

ELC-104 GM (3053) HALOGENA UGRADBENA MR16 (GU10)

▪ **Dimension:**

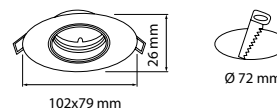

ELC-223 FR

ELC-223 FR WH HALOGENA UGRADBENA MR16

ELC-223 FR CH HALOGENA UGRADBENA MR16

ELC-223 FR NM HALOGENA UGRADBENA MR16

▪ **Dimension:**



ELC-223 FR WH



ELC-223 FR CH



ELC-223 FR NM

CE  12V IP20  0.5m 

ELC-237 FR

ELC-227 FR CH HALOGENA UGRADBENA MR16

ELC-237 FR NM HALOGENA UGRADBENA MR16

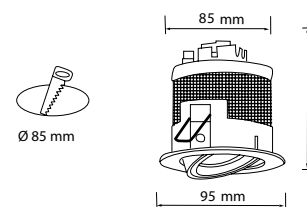

▪ **Dimension:**



ELC-237 FR CH



ELC-237 FR NM

CE  12V IP20  0.5m 

ELC-224-FR

ELC-224-FR NM HALOGENA UGRADBENA MR16

ELC-224-FR CH HALOGENA UGRADBENA MR16

▪ **Dimension:**

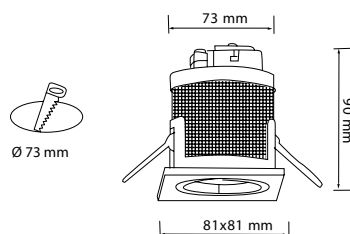

ELC-224-FR NM



ELC-224-FR CH



ELC-4237 FR

ELC-4237 FR CH HALOGENA UGRADBENA MR16

▪ **Dimension:**

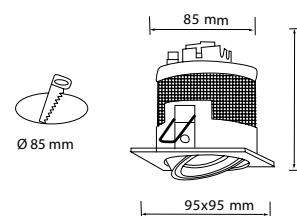

ELC-4237-FR CH



ELC-348

ELC-348 COMPLETE MR GU10

ELC-348 COMPLETE MATT WHITE GU10

▪ **Dimension:** 90x90x72mm ▪ 80x80mm 



ELC-348 COMPLETE MR



ELC-348 COMPLETE MATT WHITE



HDAE-102T

HDAE-102T HALOGENA UGRADBENA GU10, 3x50W MAX



HDAE-102T



ELC-2299

ELC-2299 WH HALOGENA UGRADBENA MR16 12V/50W MAX

ELC-2299 NM HALOGENA UGRADBENA MR16 12V/50W MAX



ELC-2299 WH



ELC-2299 NM

ELC-237TC

ELC-237TC NM HALOGENA UGRADBENA GU10 230V/50W MAX



ELC-237TC NM

ELC-217

ELC-217 NM HALOGENA UGRADBENA GU10

▪ **Dimension:** 100x100mm ▪ 87x87mm 

CE IP20 



ELC-217 NM

ELC-268

ELC-268 WH HALOGENA UGRADBENA MR16

ELC-268 NM HALOGENA UGRADBENA MR16

CE  12V IP20  

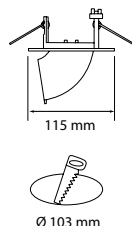

ELC-268 WH



ELC-268 NM

ELC-3044

ELC-3044 NM HALOGENA UGRADBENA MR16

CE  12V IP20  

▪ **Dimension:**

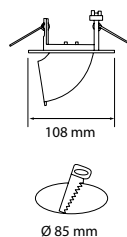

ELC-3044 NM

ELC-1821TL

ELC-1821TL M.WH HALOGENA UGRADBENA MR16 (GU10)

ELC-1821TL M.BK HALOGENA UGRADBENA MR16 (GU10)

▪ **Dimension:**  110x110 mm CE  12V IP20  



ELC-1821TL M.WH



ELC-1821TL M.BK



ELC-1822TL

ELC-1822TL M.WH HALOGENA UGRADBENA MR16 (GU10)

ELC-1822TL M.SR HALOGENA UGRADBENA MR16 (GU10)

▪ **Dimension:**     IP20  
110x195 mm



ELC-1822TL M.WH



ELC-1822TL M.SR



ELC-1823TL M.WH



ELC-1823TL M.SR



ELC-1823TL

ELC-1823TL M.WH HALOGENA UGRADBENA MR16 (GU10)

ELC-1823TL M.SR HALOGENA UGRADBENA MR16 (GU10)

▪ **Dimension:**     IP20  
110x280 mm

SQUARE CONNECTOR

SQUARE CONNECTOR FOR FRAME PROFILE WITH 4 SCREWS

   IP20  



ALUMINIUM PROFILE

ALUMINIUM PROFILE FOR FRAME IN LENGHT 2m

   IP20  

▪ **Dimension:**

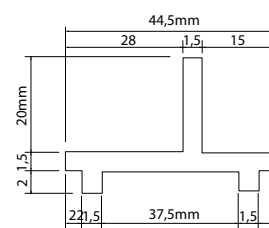

ALUMINIUM PROFILE FOR FRAME

DK3/ELC-224

DK3/ELC-224 NM HALOGENA UGRADBENA x 3 GU10 50W x 3



DK3/ELC-224



▪ **Dimension:**

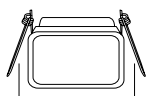

80 x 80 mm



Ø 70 mm

CE IP20



LED-F-SS+SMD



LED-F-SS+SMD



LED-F-SS+SMD LED GU10 SET SQUARE GU10, 5W, 3000K+GU10 SOCKET WH

LED SPOT GU10-05-C



LED SPOT GU10-05-C SC 6W, SC, 1S, 120*3000K

LED SPOT GU10-05-C PC 6W, SC, 1S, 120*3000K

▪ **Dimension:**

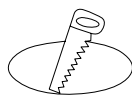

60mm

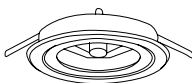

85mm



LED SPOT GU10-05-C SC



LED SPOT GU10-05-C PC

LED SPOT GU10-06-C



LED SPOT GU10-06-C PC 6W, SC, 1S, 120*3000K

▪ **Dimension:**



75mm

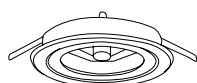

96mm



LED SPOT GU10-06-C PC

ELC-1823/1825 SR+BK

ELC-1823 SR+BK HALOGENA NADGRADBENA GU10

ELC-1825 SR+BK HALOGENA NADGRADBENA GU10

▪ **Dimension:**

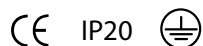
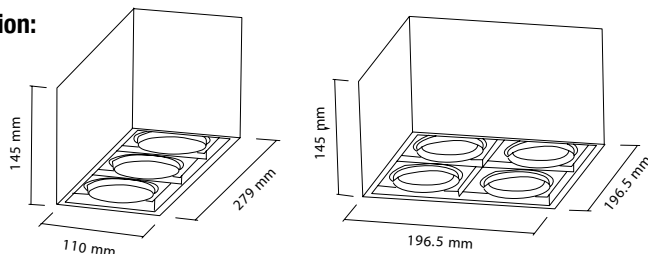

ELC-1823 SR+BK



ELC-1825 SR+BK



APL-4391S BRUSH ALU

APL-4391S BRUSH ALU

APL-4391S BRUSH ALU HALOGENA NADGRADBENA GU10

▪ **Dimension:**

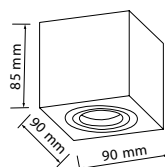

ELC-228 B

ELC-228 B WH ALUMINIUM HALOGENA UGRADBENA MR11

ELC-228 B NM ALUMINIUM HALOGENA UGRADBENA MR11

ELC-228 B CH ALUMINIUM HALOGENA UGRADBENA MR11

ELC-228 B PB HALOGENA UGRADBENA MR11

ELC-228 B GM ALUMINIUM HALOGENA UGRADBENA MR11

▪ **Dimension:**

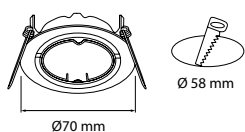

ELC-228 B WH ALUMINIUM



ELC-228 B CH ALUMINIUM



ELC-228 B NM ALUMINIUM



ELC-228 B PB



ELC-228 B GM ALUMINIUM



CR21-3

CR21-3 BLACK HALOGENA UGRADBENA G4

CR21-3 CLEAR HALOGENA UGRADBENA G4

▪ **Dimension:**

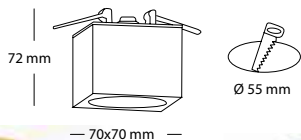

ELC-125 PB



ELC-125 MC

ELC-146+C1/C2

ELC-146+C1 CH HALOGENA UGRADBENA MR16 (GU10)

ELC-146+C2 NM HALOGENA UGRADBENA MR16 (GU10)

▪ **Dimension:**

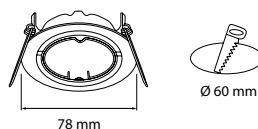

ELC-241 WH



ELC-241 BL

ELC-240

ELC-240 WH HALOGENA UGRADBENA MR16 (GU10)

ELC-240 BL HALOGENA UGRADBENA MR16 (GU10)

ELC-240 GR HALOGENA UGRADBENA MR16 (GU10)

ELC-240 PK HALOGENA UGRADBENA MR16 (GU10)

▪ **Dimension:**

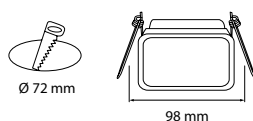

CR21-3 BLACK



CR21-3 CLEAR



ELC-125

ELC-125 PB HALOGENA UGRADBENA G4 JC 12V/20W

ELC-125 MC HALOGENA UGRADBENA G4 JC 12V/20W

▪ **Dimension:**

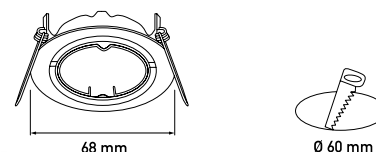

ELC-146+C1 CH



ELC-146+C2 NM

ELC-241

ELC-241 WH HALOGENA UGRADBENA MR16 (GU10)

ELC-241 BL HALOGENA UGRADBENA MR16 (GU10)

▪ **Dimension:**

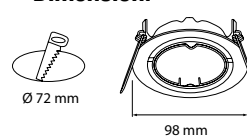

ELC-240 WH



ELC-240 BL



ELC-240 GR



ELC-240 PK

ELC-2400

ELC-2400 GR	HALOGENA UGRADBENA	MR16 (GU10)
ELC-2400 BL	HALOGENA UGRADBENA	MR16 (GU10)
ELC-2400 PK	HALOGENA UGRADBENA	MR16 (GU10)

▪ Dimension:

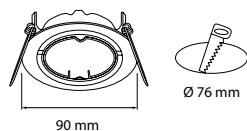

ELC-2874+C4 NM

ELC-2874+C4

ELC-2874+C4 NM	HALOGENA UGRADBENA	GU10
-----------------------	--------------------	------

▪ Dimension:

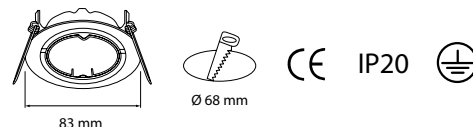

ELC-296

ELC-296 CH/BL	HALOGENA UGRADBENA	GU10
ELC-296 CH/GR	HALOGENA UGRADBENA	GU10
ELC-296 CH/YE	HALOGENA UGRADBENA	GU10

▪ Dimension:

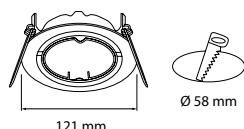

ELC-287+B MC/MC/WH



ELC-287+B MC/MC/BL

ELC-287+B

ELC-287+B MC/MC/WH	HALOGENA UGRADBENA	GU10 230V/50W MAX
ELC-287+B MC/MC/BL	HALOGENA UGRADBENA	GU10 230V/50W MAX

▪ Dimension:

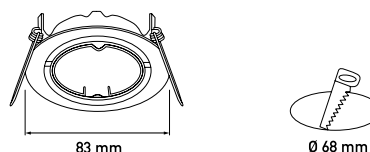

ELC-1111/ 2111/3111 WH

ELC-1111 WH HI SPOT AR111 G53

ELC-2111 WH HI SPOT AR111 G53

ELC-3111 WH HI SPOT AR111 G53



ELC-1111 WH



ELC-2111 WH



ELC-3111 WH

▪ **Dimension:**

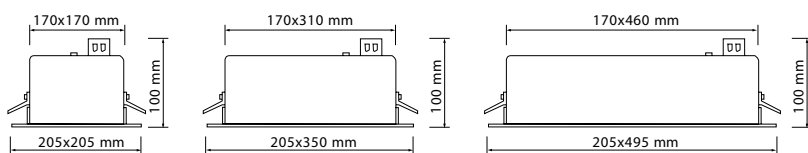

ELC-1111 SILVER



ELC-4111 SILVER



ELC-3111 SILVER



ELC-4211 SILVER

ELC-1111/ 3111/4111/4211

ELC-1111 SILVER HI SPOT AR111 G53

ELC-3111 SILVER HI SPOT AR111 G53

ELC-4111 SILVER HI SPOT AR111 G53

ELC-4211 SILVER HI SPOT AR111 G53

▪ **Dimension:** CE F 12V IP20 0.5m III

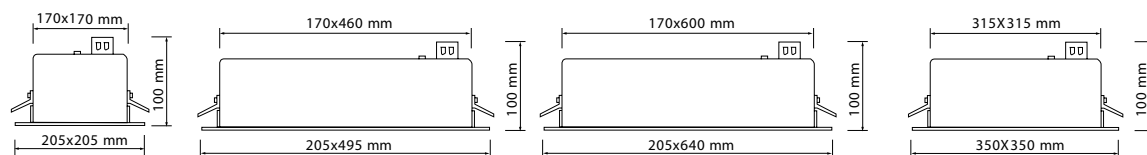

ELC-3111 TL

ELC-3111 TL BLACK HI SPOT AR111 G53

▪ **Dimension:**

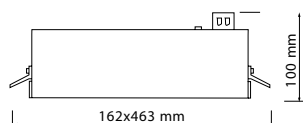

ELC-3111 TL BLACK

CE F 12V IP20 0.5m III

ELC-1921TL

ELC-1921TL M.SR HALOGENA UGREDBENA AR111 (GU10)

▪ **Dimension:**



170x170 mm



ELC-1921TL M.SR



ELC-1922TL

ELC-1922TL M.WH HALOGENA UGRADBENA MR16 (GU10)

ELC-1922TL M.SR HALOGENA UGRADBENA MR16 (GU10)

▪ **Dimension:**



170x320 mm



ELC-1922TL M.WH



ELC-1922TL M.SR



ELC-1923TL M.SR

ELC-1923TL

ELC-1923TL M.WH HALOGENA UGRADBENA MR16 (GU10)

ELC-1923TL M.SR HALOGENA UGRADBENA MR16 (GU10)

▪ **Dimension:**

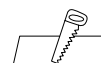

170x465 mm



ELC-1923TL M.WH



SQUARE CONNECTOR

SQUARE CONNECTOR FOR FRAME PROFILE WITH 4 SCREWS

CE 12V IP20



ALUMINIUM PROFILE FOR FRAME



ALUMINIUM PROFILE

ALUMINIUM PROFILE FOR FRAME IN LENGTH 2m

CE 12V IP20

ELC-1923/ 1924/1925 SR+BK

ELC-1923 SR+BK	NADGRADBENA	AR111 G53/GU10
ELC-1924 SR+BK	NADGRADBENA	AR111 G53/GU10
ELC-1925 SR+BK	NADGRADBENA	AR111 G53/GU10

▪ **Dimension:**

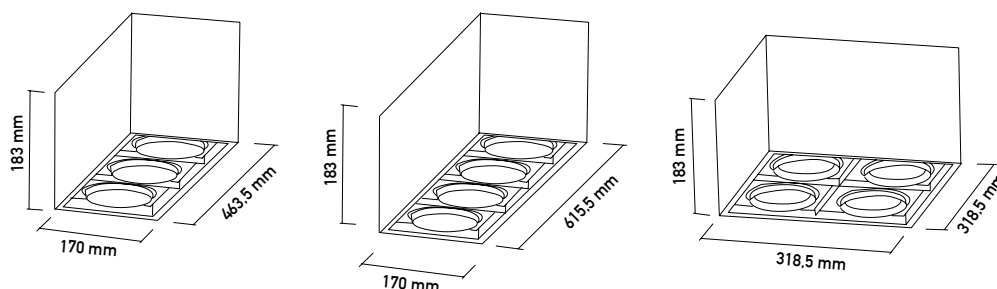

APL550S BR/ALU

APL550S BR/ALU VISILICA TEHNIČKA GU10 AR111

CE IP20 ⚡

▪ **Dimension:**

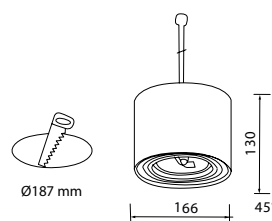

APL550S BR/ALU



APL549S BR/ALU

▪ **Dimension:**

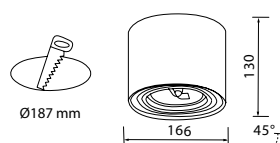

APL549S BR/ALU

APL549S BR/ALU NADGRADNA STROPNA GU10 AR111

CE IP20 ⚡

APL-1110/ 3110/ 4110/ 4210PL AL/WL AL

APL-1110 PL AL	VISILICA TEHNIČKA	AR111 GU10
APL-3110 PL AL	VISILICA TEHNIČKA	AR111 GU10
APL-4110 PL AL	VISILICA TEHNIČKA	AR111 GU10 LONG
APL-4210 PL AL	VISILICA TEHNIČKA	AR111 GU10 SQUARE
APL-1110 WL AL	ZIDNA TEHNIČKA	AR111 GU10 WITH FIX BRACKET



APL-1110 PL AL



APL-3110 PL AL



APL-4110 PL AL



APL-4210 PL AL



APL-1110 WL AL

Dimension:

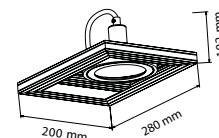
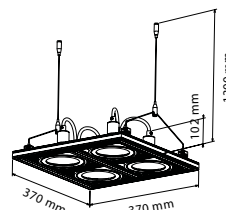
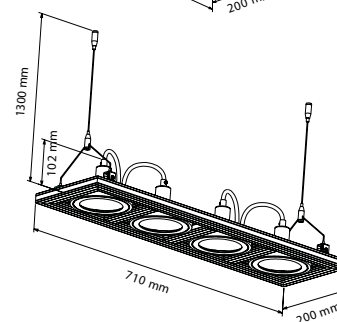
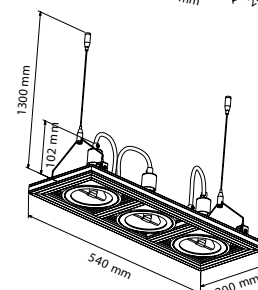
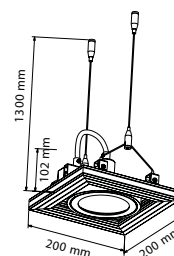

ZIDNI DRŽAČ

ZIDNI DRŽAČ FIKSNI KRATKI

ZIDNI DRŽAČ POMIČNI DUGI



FIKSNI KRATKI



POMIČNI DUGI

ROZETA S VODIČEM

ZA APL-1110PL

ZA APL-2110PL

ZA APL-4110PL

ZA APL-1110WL



LED-DL-MLA223030

LED-DL-MLA223030 ROUND WHITE AC220-240V, 30W, 4000K, 2700lm



LED-DL-MLA223030



LED-DL-MLA223030

LED-DL-MLA341080

LED-DL-MLA341080 SQUARE WHITE AC220-240V, 40W, 4000K, 3600lm

LED 514,515

LED 514 2W 6000K DC 3,6V, 500mA, 2W LED CREE, Led napajanje u kompletu AC 230V

▪ **Dimension:** 25x58mm ▪ Ø20mm 

LED 515 2W 6000K DC 3,6V, 500mA, 2W LED CREE, Led napajanje u kompletu AC 230V

▪ **Dimension:** 25x25x58mm ▪ Ø20mm 



LED 515 2W 6000K



LED 514 2W 6000K

CL4491

CL4491 15W, 3000K, 38°, 1220lm, DIMMABLE

▪ **Dimension:** 105x105x70mm ▪ 98x98mm 



CL4491

CL603A

CL603A 12W, 3000K, 38°, 860lm, IP65, DIMMABLE

▪ **Dimension:** Ø85x100mm ▪ Ø72mm 



CL603A

LED 502

LED 502 1W 6000K DC3,6V, 350mA, Led napajanje u kompletu

▪ **Dimension:** 60x89mm ▪ Ø52mm 



LED 502 1W 6000K

SD-C019-4WW/4DW



SD-C019

SD-C019-4WW 3000K

SD-C019-4DW 4000K

- **Dimension:** Ø90mm
- Ø75mm 
- 4W diffuse reflection round LED downlight
- LED chip: Epistar SMD 2835
- CCT: SD-C019-4WW: 3000K
SD-C019-4DW: 4000K
- CRI>80
- 85-265V 50-60Hz

SD-C020-8DW

SD-C020-8DW 4000K

- **Dimension:** 105x105mm
- 95x95mm 
- 8W diffuse reflection square LED downlight
- LED chip: Epistar SMD 2835
- CCT: SD-C020-8DW: 4000K
- CRI>80
- 85-265V 50-60Hz



SD-C020

SD-C020-16WW/16DW

SD-C020-16WW 3000K

SD-C020-16DW 4000K

- **Dimension:** 140x140mm
- 130x130mm 
- 16W diffuse reflection square LED downlight
- LED chip: Epistar SMD 2835
- CCT: SD-C020-16WW: 3000K
SD-C020-16DW: 4000K
- CRI>80
- 85-265V 50-60Hz



SD-C020

SD-C020-20WW/20DW

SD-C020-20WW 3000K

SD-C020-20DW 4000K

- **Dimension:** 180x180mm
- 165x165mm 

- 20W diffuse reflection square LED downlight
- LED chip: Epistar SMD 2835
- CCT: SD-C020-20WW: 3000K
SD-C020-20DW: 4000K
- CRI>80
- 85-265V 50-60Hz



SD-C020

SD-P001-18DW DIM

SD-P001-18DW DIM 4000K, DIMMABLE

- **Dimension:** Ø220mm
- Ø200mm 
- 18W round led panel light
- Lumen: 90-100lm/W
- LED chip: Epistar
- Material: aluminium+PC
- Dimmable
- CCT: SD-P001-18DW: 4000K
- Beam angle: 120°
- 85-265V 50-60Hz



SD-P001-18DW DIM

SD-P002-18WW/18DW DIM

SD-P002-18WW DIM 3000K, DIMMABLE

SD-P002-18DW DIM 4000K, DIMMABLE



SD-P002-18WW/18DW DIM

- **Dimension:** 220x220mm
- 200x200mm 
- 18W square led panel light
- Lumen: 90-100lm/W
- LED chip: Epistar
- Material: aluminium+PC
- Dimmable
- CCT: SD-P002-18WW: 3000K
- SD-P002-18DW: 4000K
- Beam angle: 120°
- 85-265V 50-60Hz

SD-P001S-12WW/12DW DIM

SD-P001S-12WW DIM 3000K, DIMMABLE

SD-P001S-12DW DIM 4000K, DIMMABLE

- **Dimension:** Ø180mm
- 12W surface round panel light
- Lumen: 90-100lm/W
- LED chip: Epistar
- Material: aluminium+PC
- Dimmable
- CCT: SD-P001S-12WW: 3000K
- SD-P001S-12DW: 4000K
- Beam angle: 120°
- 85-265V 50-60Hz



SD-P001S-12WW/12DW DIM

SD-P001S-18WW/18DW DIM

SD-P001S-18WW DIM 3000K, DIMMABLE

SD-P001S-18DW DIM 4000K, DIMMABLE



SD-P001S-18WW/18DW DIM

- **Dimension:** Ø240mm
- 12W surface round panel light
- Lumen: 90-100lm/W
- LED chip: Epistar
- Material: aluminium+PC
- Dimmable
- CCT: SD-P001S-18WW: 3000K
- SD-P001S-18DW: 4000K
- Beam angle: 120°
- 85-265V 50-60Hz

SD-P002S-12WW/12DW DIM

SD-P001S-12WW DIM 3000K, DIMMABLE

SD-P001S-12DW DIM 4000K, DIMMABLE

- **Dimension:** 180x180mm
- 12W surface square panel light
- Lumen: 90-100lm/W
- LED chip: Epistar
- Material: aluminium+PC
- Dimmable
- CCT: SD-P002S-12WW: 3000K
SD-P002S-12DW: 4000K
- Beam angle: 120°
- 85-265V 50-60Hz



SD-P002S-12WW/12DW DIM

SD-P002S-18WW/18DW DIM

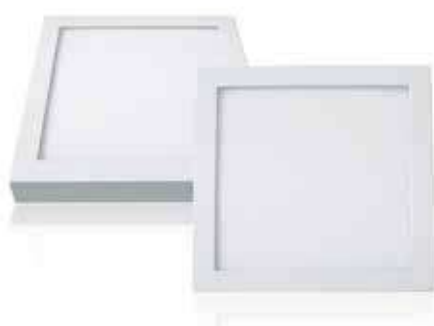

SD-P002S-18WW/18DW DIM

SD-P002S-18WW DIM 3000K, DIMMABLE

SD-P002S-18DW DIM 4000K, DIMMABLE

- **Dimension:** 240x240mm
- 18W surface round panel light
- Lumen: 90-100lm/W
- LED chip: Epistar
- Material: aluminium+PC
- Dimmable
- CCT: SD-P001S-18WW: 3000K
SD-P001S-18DW: 4000K
- Beam angle: 120°
- 85-265V 50-60Hz

SD-P005-6DW

SD-P005-6DW ANTRACIT AC220-240V, 6W, 120°, 4000K

- **Dimension:** Ø90x10mm
- Ø76mm 



SD-P005-6/12/24DW

ELC-2035 MR

ELC-2035 MR GU10 230V/50W

- **Dimension:** Ø68x133mm



ELC-2035 MR

ELC-2038 MR

ELC-2038 MR R7S 100W MAX

- **Dimension:** W165XHØ100X105mm



ELC-2038 MR

LED1216P AL



LED1216P AL 3W, 6000K, 230 VAC, LED NAPAJANJE U KOMPLETU



LED1216P AL

WATERPROOF SWITCH:



LED MIRROR ML-WS50

LED MIRROR ML-WS50



LED MIRROR ML-WS50 AC220-240V, 20W, 1600Lm

▪ **Dimension:** 900x53x65mm



CE RoHS



LED DRAWER LIGHT BLS 17

LED DRAWER LIGHT BLS 17 DC6V, 0.8W, 50LM, 4xAAA battery

▪ **Dimension:** H18xL300xW17mm



LED DRAWER LIGHT BLS 17

CE RoHS



LED DRAWER LIGHT BLS 47

LED DRAWER LIGHT BLS 47 DC4.2-5V, 0.8W, 50lm, rechargeable batteries included

▪ **Dimension:** H13xL100xW49mm



LED DRAWER LIGHT BLS 47

GQD2015

GQD2015 MR16, 2xGU5.3 HALOGEN (MAX 35W)

- **Dimension:** 240x130x55mm
- 243x133mm 



GQD2015

GQD2049

GQD2049 MR16, 2xGU5.3 HALOGEN (MAX 35W)

- **Dimension:** 510x120x76mm
- 513x123mm 



GQD2049

GQD1002

GQD1002 MR16, GU5.3 HALOGEN (MAX 35W), 12V

- **Dimension:** Ø110x55mm



GQD1002



GQD1008

GQD1023

GQD1023 MR16, GU5.3 HALOGEN (MAX 35W), 12V

- **Dimension:** 124x124x40mm



GQD1023



GQD4010

GQD1008

GQD1008 MR16, GU5.3 HALOGEN (MAX 35W), 12V

- **Dimension:** Ø111x55mm

GQD4010

GQD4010 2xAR111 (GU10)

- **Dimension:** 420x217x80mm
- 423x220mm 

GQD4011

GQD4011 3xAR111 (GU10)

- **Dimension:** 615x218x78mm
- 618x221mm 

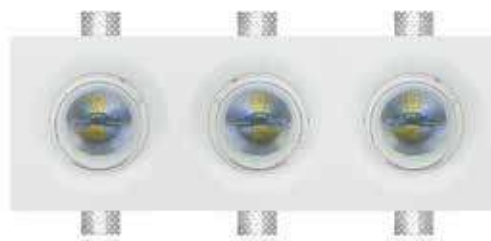

GQD4011



T8 FIXTURE + LED T8 TUBE



T8 FIXTURE 1x1200mm + LED T8 TUBE 1x18W	1x18W, 1200mm
T8 FIXTURE 1x1500mm + LED T8 TUBE 1x24W	1x24W, 1500mm
T8 FIXTURE 2x600mm + LED T8 TUBE 2x9W	2x9W, 600mm
T8 FIXTURE 2x1500mm + LED T8 TUBE 2x24W	2x24W, 1500mm

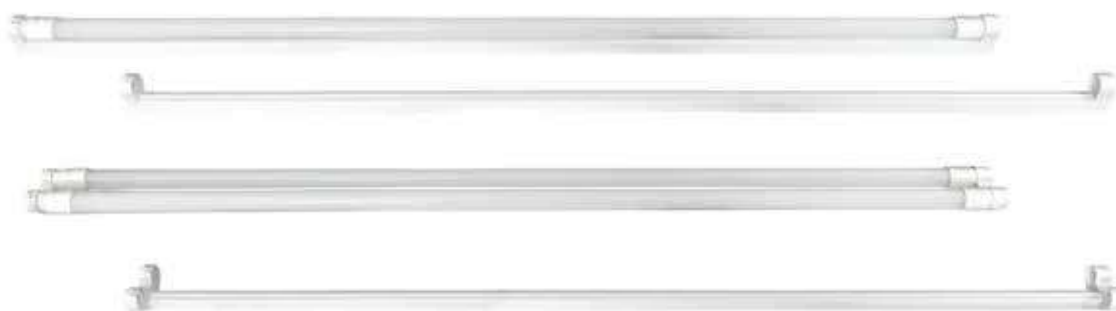

T8 FIXTURE + T8 TUBE

LED-T8-GL/STD



LED-T8-GL/STD	LED T8 TUBE	24W, 4000K, 2400lm	<ul style="list-style-type: none">▪ Lumen Efficacy (lm/W): 100▪ IP: IP20▪ Beam angle: 200°▪ LED: SMD2835▪ Cap: G13▪ Input: AC220-240V	<ul style="list-style-type: none">▪ Hz: 50Hz▪ Ra: 80▪ PF: 0,9▪ Life Time: 25000h▪ EEL: A+▪ Individual packaging: color box
----------------------	-------------	--------------------	--	---



LED-T8-GL/STD



ARMATURE ZA LED CIJEVI

ZATVORENE IP20 ARMATURE ZA LED CIJEVI

U1 0 1x18W	IP20, 705x115mm
U1 0 2x18W	IP20, 705x145mm
U1 0 1x36W	IP20, 1315x115mm

LED STRIP KONEKTOR

STRIP TO STRIP

STRIP TO WIRE

NAZIV ARTIKLA	OPIS	BOJA LED TRAKE	VRSTA SPOJA	ŠIRINA LED TRAKE	TRAKA IP
OL11-SEN8BB-2	LED strip connector	single color	strip to strip	8mm (4,8W; 9,6W)	IP20
OL11-SEN10XB-2	LED strip connector	single color	strip to wire	10mm (7,2W; 14,4W)	IP20
OL11-SEN10BB-2	LED strip connector	single color	strip to strip	10mm (7,2W; 14,4W)	IP20
OL11-SEN10XB-4	LED strip connector	RGB	strip to wire	10mm (7,2W; 14,4W)	IP20
OL11-SEN10BB-4	LED strip connector	RGB	strip to strip	10mm (7,2W; 14,4W)	IP20
OL11-DJN10XB-2	LED strip connector	single color	strip to wire	10mm (4,8W; 7,2; 9,6; 14,4W)	IP54/IP65
OL11-DJN10XB-4	LED strip connector	RGB	strip to wire	10mm (7,2W; 14,4W)	IP54/IP65
OL11-DJN10BB-4	LED strip connector	RGB	strip to strip	10mm (7,2W; 14,4W)	IP54/IP65



STRIP TO STRIP



STRIP TO WIRE

Step 1: Connect to LED Strip Light



1-1: Cut LED Strip along the cuttable mark



1-2: Remove protective paper of adhesive tape



1-3: Insert LED strip to strip holder and press cap down



1-4: Finish connection to LED Strip

Step 2: Attach Wire to Connector



2-1: Insert wire to wire holder of connector



2-2: Down close cap of connector



2-3: Ensure cap is locked by base of connector



2-4: Connection completed

LED MODULE DIMMABLE

LED MODULE DIMMABLE 8W, LED, GX53, 4000K, NEUTRAL WH 230V INPUT

LED MODULE DIMMABLE 8W, LED, GX53, 3000K, WARM WH 230V INPUT

▪ **Dimension:** 75x41.5mm



Model	GX53-8W-D
Input Voltage	AC220-240V
Work Current	500mA
Power	8W
Lumens	450lm
Light Color	3000K, 4000K
View Angle	120 D
Work temp.	Below 50D
Base	GX53
Shield	Al, heat sink
Dimension	D70*H41MM
Certificate	CE, ROHS



GX53 sockets A



GX53 sockets B



LED MODUL

BL-LMN5630W03

LED MODUL BL-LMN5630W03 SAMSUNG 5630 LED

40-50lm/LED, DC12V, Al. PCB, 6000-7000K

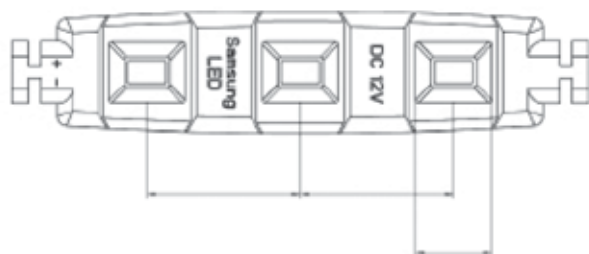

Waterproof Module 3-LED
with aluminum PCB

Description	5630 LED Module 3-LED
Power (W)	1.24
LED quantity	3
Dimensions (mm)	63.5X16X6.8
IP rating	65
Colour temperature (K)	6000
Lumens output (Lm)	105- 115
Luminous efficacy (Lm/W)	>88
Angle (°)	120
Type of LED	5630 SAMSUNG
PCB	Aluminum
Housing	PVC
Voltage (V)	12
Driver position	outside
Lifespan (hours)	50000
Light degradation	(%/xHours)
Materials	PVC casing + Aluminum PCB
Working Temperature (°C)	-40 - 85
Warranty	3 year

LED MODUL

BL-LMN5050RGB03

LED MODUL BL-LMN5050RGB03 SAMSUNG 5630 LED

DC12V, RGB FULL COLOR

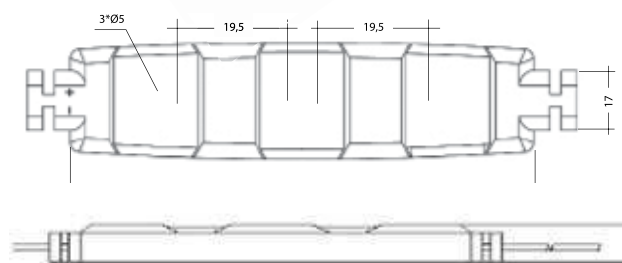

Waterproof Module 3-LED
with aluminum PCB

Description	EPISTAR 5050LED
Power (W)	0.72
LED quantity	3
Dimensions (mm)	65.5X17X6.5
IP rating	65
Colour temperature (K)	RGB tri-color
Lumens output (MCD)	R: 1200-1800 mcd G: 2700-3300 mcd B: 2700-3300 mcd
Luminous efficacy (Lm/W)	
Angle (°)	120
Type of LED	5060 SMD
PCB	FR4 PCB
Housing	PVC
Voltage (V)	12
Driver position	outside
Lifespan (hours)	> 30000
Light degradation (%/xHours)	
Materials	PVC casing + FR4 PCB
Working Temperature (°C)	-40 - 85
Warranty	2 year





