

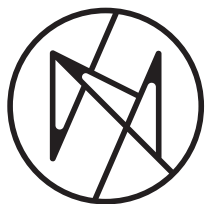

Nowodvorski
LIGHTING



Nowodvorski
LIGHTING



Tadeusz Nowodvorski



Bartłomiej Nowodvorski



Olga Krywult



Anna Bielnik



Aleksandra Kania-Biegus



Łukasz Jaworski

NOWODVORSKI LIGHTING

Za każdą lampą Nowodvorski Lighting stoi historia pasji, dbałości o jakość i zamiłowania do nowatorskich rozwiązań.

Behind every Nowodvorski Lighting lamp lies a story of passion, commitment to quality, and a love for inventive solutions.



Borys Nowodvorski



Tomasz Słabiak



Agnieszka Solecka



Design Lab



Małgorzata Nowodvorska

Naszą podróż rozpoczęliśmy w 1994 roku jako mała, rodzinna firma. Dziś, obecni na 45 rynkach świata, tworzymy oświetlenie dla domów, mieszkań i przestrzeni HORECA. Pomagamy piękniej żyć. Udowadniamy, że wyjątkowe wnętrza tworzy się światłem.

Our journey began in 1994 as a small family-owned company. Today, present in 45 markets worldwide, we create lighting for homes, apartments, and HORECA spaces. We inspire a more beautiful life, proving that exceptional interiors are shaped by light.

Sercem naszej marki jest dział rozwoju produktów – Design Lab. To tutaj rodzą się pomysły, które zespół projektantów i konstruktorów przekuwa w wyjątkowe kolekcje. Dopracowane wzornictwo, przemyślana funkcjonalność i pełne skupienie na użytkowniku sprawiają, że nasze oświetlenie wykracza poza utarte schematy. Tworzymy nie tylko lampy zdobiące wnętrza, ale przede wszystkim światło, które pisze codzienne scenariusze.



At the heart of our brand is the Design Lab – our product development department. This is where ideas are born and shaped into unique collections by our team of designers and engineers. Thoughtfully designed aesthetics, carefully considered functionality, and a strong focus on the user make our lighting stand out from the ordinary. We create not just lamps that decorate interiors but also light that sets the scene for everyday life.



Wojciech Paul



Wiktoria Morawska



Damian Olszak



Nasze oprawy powstają w dwóch zakładach produkcyjnych – w Częstochowie i Siemianowicach Śląskich. Każdego dnia ponad 300-osobowy zespół dba o to, by produkty, które trafią do Twojego wnętrza, wyróżniały się designem, precyzją wykonania i najwyższą jakością. Możemy spełnić tę obietnicę dzięki 20 000 m² powierzchni produkcyjnej i magazynowej, obejmującej nowoczesny, zautomatyzowany park maszynowy, laboratorium fotometryczne oraz centrum logistyczne.



Our lighting fixtures are manufactured in two production facilities – in Częstochowa and Siemianowice Śląskie. Every day, our team of over 300 people ensures that the products reaching your interiors stand out with their design, precise craftsmanship, and top quality. We can fulfill this promise thanks to 20,000 m² of production and warehouse space, which includes a modern, automated machine park, a photometric laboratory, and a logistics center.

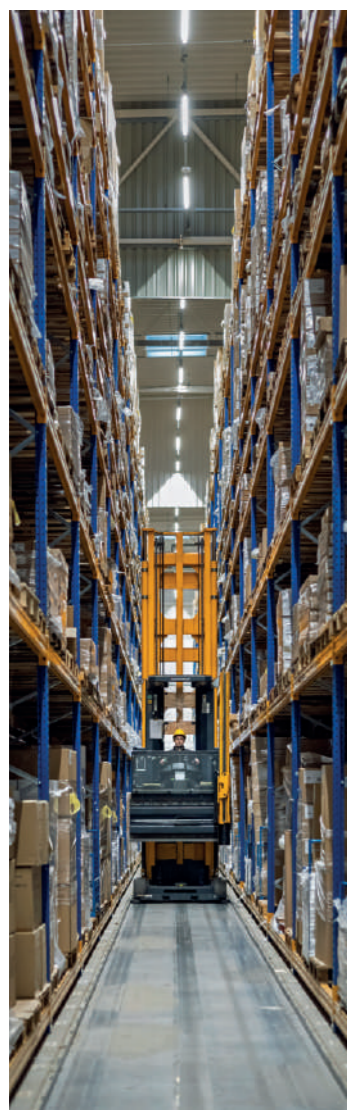

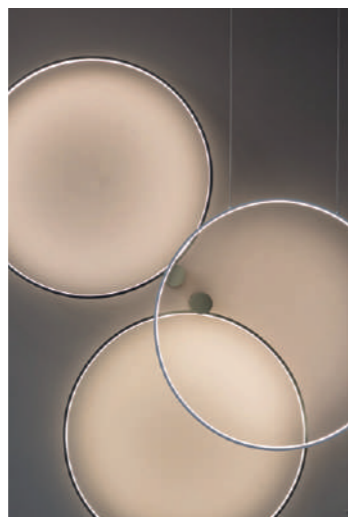

Nasze lampy rozświetlą Twoje wnętrza i pomogą stworzyć wyjątkową atmosferę. Odwiedź Dom Marki Nowodvorski Lighting, nasze stoiska targowe i salony partnerskie – przekonaj się, jak łatwo możesz odmienić swoje otoczenie światłem.

Our lamps will brighten your interiors and help you create a unique atmosphere. Visit the Nowodvorski Lighting Brand Home, our trade fair stands, and partner showrooms to discover how easily you can transform your surroundings with light.

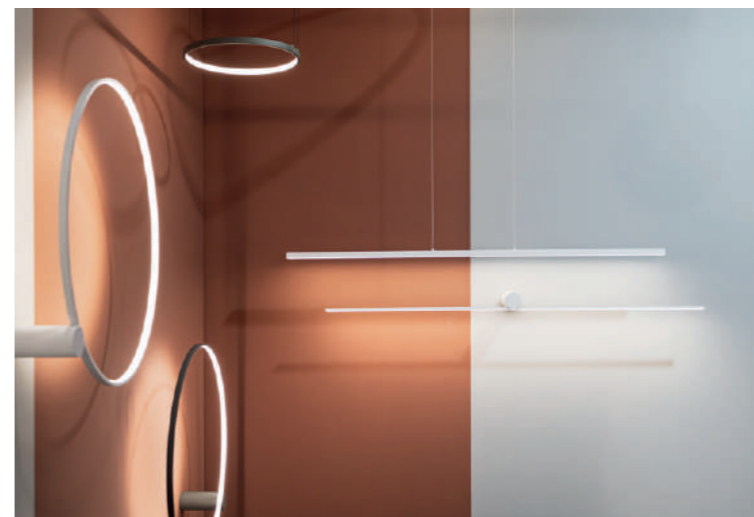

COLLECTIONS



CIRCOLO LED 24-32



CIRCOLO POWER LED 25-26

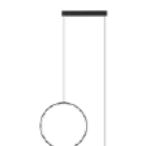

LINEO LED 34



VERTIC LED 35



GIAVELLOTTO LED 37



BAR LED 40-41



MOTIVE LED 42



SABER LED 44-45



EASY LED 46



ARM LED 48



SLASH LED 49



SPIN LED 51



IMPULSE LED 52-53



VAN GOGH LED 54



ORTO 58-59



LASER 60-64



STALACTITE 65



LASER WALL 66-67



FOURTY 70-73



FOURTY WALL 74-75



FOURTY SPOTLIGHTS 76-77



MONO S 80-81



MONO SPOTLIGHTS 82-86



MONO CORNER 87



MONO LONG 88



MONO WALL 89



MONO SURFACE 90-91



MONO DEEP 92



MONO SLIDE 93



MONO FLOOR 94-95



MONO TABLE 95



EYE PENDANT 96-98



BATON 99



CYLINDER 100



EYE 101



EYE WALL 102



EYE FLEX 103



EYE SPOT 104-105

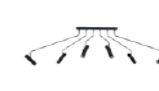

EYE SUPER 106-109



MORE EYE 110



MORE TONE 111



IMBRIA 112



SLING 113



KARO 116-117



SNOWBALL 120



KIER 121



PIK 122



GLOBE PLUS 123



SPHERE 124-125



PEAR 126-127



LUXORA LED 130-131



CRISTAL 132-133



HAMPTON 134



NEWPORT 135



CERAMIC LED 138-139



CLAY 141



POLARIS 142



AMALFI 143



MONACO 144-145



VETRO 146-147



SANTANA 150-153



AMARELA 154-157



CEDRO 160-163



LAGO 166-169



TUTOIA 171

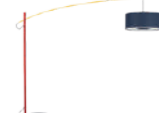

POISE 172



TURDA 176-178



LAGUNA 179



CADILAC 180-181



MIST 182



FORM 183



CAMERON 184-185



VIVIANE 186



VIOLET 187



VIPER 188



FALCON 189



ALICE 190-191



HOTEL MOOD 192-194

											
HOTEL PLUS 196	MOSS 197	CHILIN 198	LUSSO 199	DROPS WOOD 202-205	SUNSET 208, 211	MALMO 269	RING MIRROR LED 271	RING LED 272-273	COMMA LED 275	RADIUS 276-277	WORKSHOP 278
											
SUNSET NATURAL 209	SUNSET LED 210	SUNRISE LED 210	SUN LED 211	RING TIMBER LED 212	WHEEL 214	SILICONE 279	SPIDER 280	TWIG 281	CRATE 282	PLANT 283	TECHNO 284-285
											
WHEEL LUX 214-215	RING WOOD LED 216	DISK 218	HEFT 219	KYMI 222	IKA 223	HARMONY 284	PANTOGRAPH 286	CRAFT 287	HIGH-BAY 288	GARRET 289	HEMISPHERE RUST 290
											
DOVER 226-227	MINIMAL 228	OSLO 228-229	RATTAN 230	PUKET 231	HAVANA 232-233	HEMISPHERE SUPER 291,293	HEMISPHERE HIT 292	CANOE 294	EGG 295	ARES 296	GIOTTO LED 297
											
HAITI 234	BOHO 235	JAPANDI 236	KRABI 237	PUMPKIN 240-241	WAVE 242	ORGANIC 298	IRIS LED 299	LIA LED 299	TUBE 299	STRAIGHT CEILING LED 300	STRAIGHT WALL 301
											
NESS 242	LUKSOR 243	ABI 243	SIMONE 246	POINT DUO 248	ZENITH 252-254	SOFT WALL LED 302	SOFT LED 303-304	ION LED 305	CL OFFICE LED PRO 306-307	MULTI LED 308	NIKKI ROUND LED 310
											
SATELLITE 258-259	HERMANOS 260-261	ORBIT 263-265	PILLS 266-267	BERGEN 269	HAGA 269	LID ROUND LED 313	LID SQUARE LED 314	ARENA 316	KASAI 317	SMART LED 319	

DOWNLIGHTS



COBBLE 322 GAP 322 GROOVE 322-323 PAG 322 OVAL 323 MIDI LED 324-325



MIDI LED RECESSED 326 MINI LED RECESSED 329 FOCUS MINI LED 330 CL IOS LED 332-333 HALO 334 POINT TONE 334



INDIA 335 FLEA 335 SET 336 EYE TONE 337-338 POINT PLEXI 339 BIT 339



POINT 339 SILBA 340 CRES 340 MURTER 340 MLJET 340 VIS 341



HVAR 341 SOLTA 341 SHINE 341 UNO 342 CUP 343 MYKONOS LED 344



EGINA LED 345 CL KOS LED 346 CL DIA LED 348 CL KEA LED 349 MOD 350 DOWNLIGHT ES111



EYE MOD 352 DOT 353

NANO LVM LOW VOLTAGE MAGNETIC TRACK LIGHT SYSTEM 24V

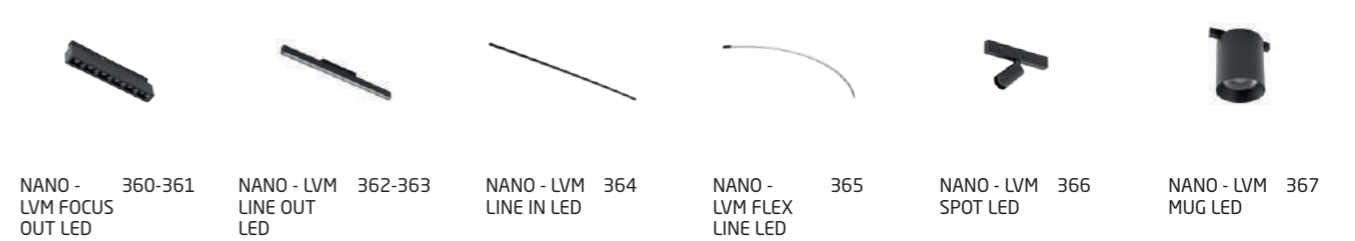

NANO - LVM FOCUS OUT LED 360-361 NANO - LVM LINE OUT LED 362-363 NANO - LVM LINE IN LED 364 NANO - LVM FLEX LINE LED 365 NANO - LVM SPOT LED 366 NANO - LVM MUG LED 367



NANO - LVM SPOT ZOOM LED 368-369 NANO - LVM TRACKS AND ACCESSORIES 370-379

ULTRA THIN LVM LOW VOLTAGE MAGNETIC TRACK LIGHT SYSTEM 48V

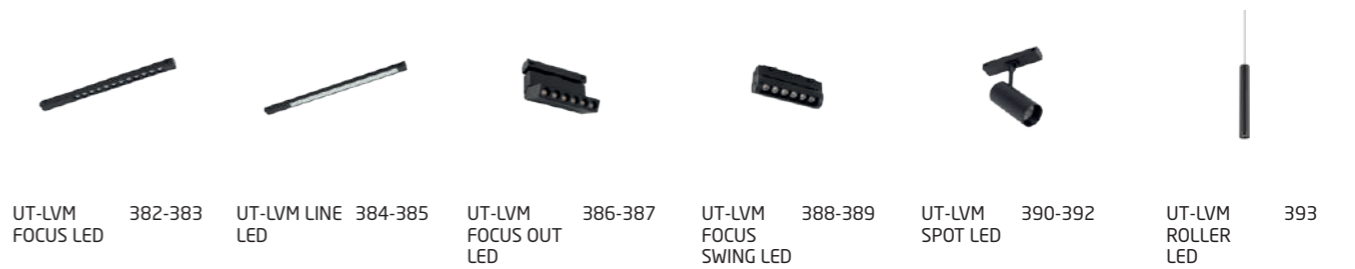

UT-LVM FOCUS LED 382-383 UT-LVM LINE LED 384-385 UT-LVM FOCUS OUT LED 386-387 UT-LVM FOCUS SWING LED 388-389 UT-LVM SPOT LED 390-392 UT-LVM ROLLER LED 393



UT-LVM TRACKS AND ACCESSORIES 394-397

LVM LOW VOLTAGE MAGNETIC TRACK LIGHT SYSTEM 48V

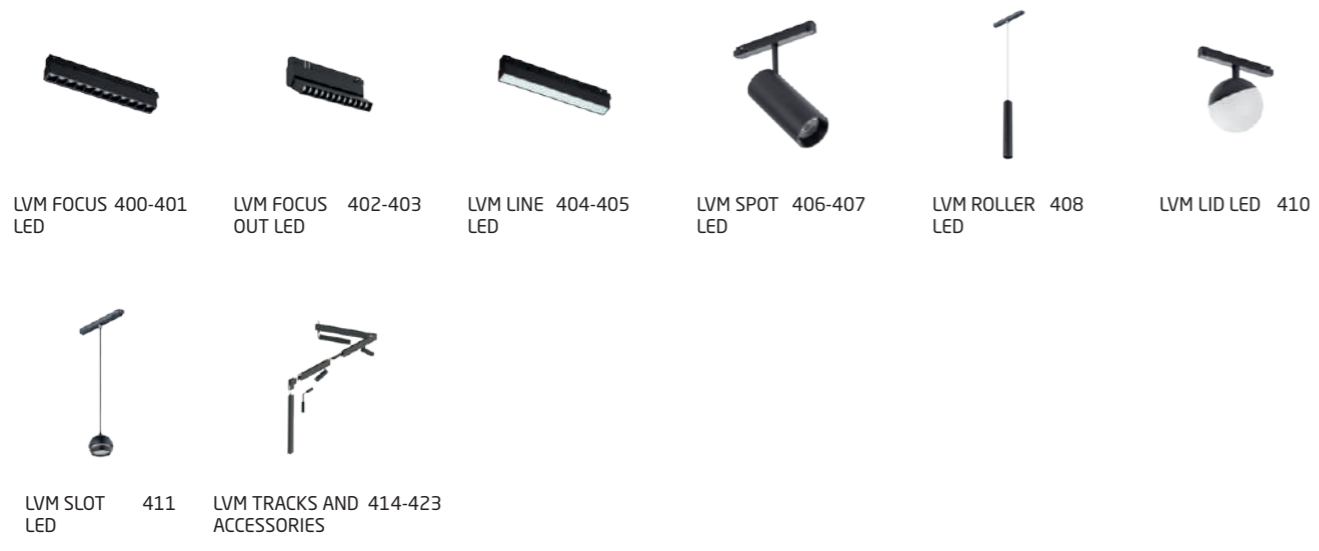

LVM FOCUS 400-401 LED LVM FOCUS OUT LED 402-403 LVM LINE 404-405 LED LVM SPOT 406-407 LED LVM ROLLER 408 LED LVM LID LED 410

LVM SLOT LED 411 LVM TRACKS AND ACCESSORIES 414-423

CTLS COMMERCIAL TRACK LIGHT SYSTEM



CTLS MILO 426-427 LED CTLS NEA 428-430 LED CTLS TINOS 432-433 LED CTLS SNOWBALL 434 CTLS MONO 435 CAMELEON ADAPTER CTLS 435

CTLS TRACKS AND ACCESSORIES 436-443

PROFILE TRACK LIGHT SYSTEM



PROFILE TINOS LED 446-447 PROFILE IRIS LED 448-449 PROFILE MIKE 450 PROFILE INDIA 450 PROFILE FOCUS LED 450 PROFILE ZOOM LED 451

PROFILE EYE SUPER 452 PROFILE SNOWBALL 452 PROFILE BIT PLUS 453 PROFILE BIT 453 PROFILE EYE 453 PROFILE EYE SPOT 454

PROFILE MONO 454 PROFILE PUCK 454 PROFILE SNOWBALL 455 PROFILE VESPA 455 CAMELEON ADAPTER PROFILE 455 PROFILE TRACKS AND ACCESSORIES 456-463

BATHROOM LIGHTING



ICE BALL 466 ALOE 466 ARALIA 467 AGAVE 467 NATALIE 469 ICE TUBE 470-471 LED

BRAZOS 472-473 SIMI 473 ICE EGG 474 SIS 475 CAYO 475 VISTA 476



PAN LED 477 MALAKKA LED 477 TORCH 478 CEARA 478 PALMAS LED 479 BRAVO 480 ZOLA LED 507 RUBY LED 508 TESSA LED 508 LIV LED 509 MIA LED 510 IDA 511



PARANA 480 BOL 481 MAUN 481 ALPHA 481 FOXTROT 482-483 CHARLIE 484 SLIT LED 512 SLIM LED 513 LHOTSE LED 513 STRUCTURE LED 514 SYMMETRY LED 515 TEPIC LED 516



DELTA 484 GOLF 485 ECHO 485 JULIET 486 HELIOS LED 486 ACRE 487 MONTERREY LED 516 THIKA LED 517 POLE LED 518 ZURI LED 519 OTTAWA 520 SOUL 521



BAHIA 487 PIN LED 488 PICASSO LED 489 LATH LED 489 CEZANNE LED 491 AGNES ROUND LED PRO 492 NORIN 522 HORN 522 TUBINGS 523 RIO 524-525 OIR 525 MEKONG 526



AGNES SQUARE LED PRO 493 MISTRAL 527 PATHWAY LED 528-529 NEL LED 530 ORLA LED 531 ISLA LED 532 DEMI LED 533

OUTDOOR LIGHTING



ARIA LED 535 TRIANGLES LED 536 ELLIPSES LED 536 SEMI LED 537 MARGOT 538 LENS LED 539



STONE 496 CUMULUS 498-499 FLOWERPOT 500 CUMULUS CUBE 502 STAR 503 PATIO 503 ASSOS 540 PRIMM 540 ARRIS 541 NICO 541 FOG 542 NEGRO 543



EXE 543 ROCK PRO 544 SIERRA 544 HEXA 545 EDESA LED 545 QUARTZ 546



AMUR 572 TAY 572 LANTERN 573 TYBR 573 DON 573 NOOK 574



ORINOKO 546 CABO LED 547 UNIT LED 547 BRICK 547 OSCAR 548 KHUMBU 549



TAHOE 575 FESTOON LIGHTS 577



MUNO LED 549 PICNIC LED 550 AMY LED 552 NALA LED 554 MAHE LED 555 PUEBLA LED 556

LIGHT SOURCES AND ACCESSORIES



MERIDA LED 556 PIX LED 557 OUTLINE LED 558 CLINE LED 560 ABBY LED 561 AVA LED 561



BULB LED G9, 7W 580 BULB LED G9, 4W 580 BULB LENS LED, G9, 3W 580 REFLECTOR LED, GU10, R35, 4W 581 REFLECTOR LED, GU10, R50, 7W 581 REFLECTOR LED, GU10, R50, 7W, DIMMABLE 581

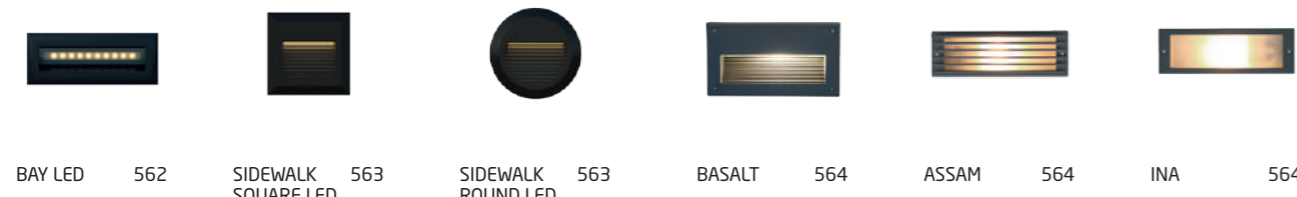

BAY LED 562 SIDEWALK SQUARE LED 563 SIDEWALK ROUND LED 563 BASALT 564 ASSAM 564 INA 564



BULB GLASS BALL LED, E27, 8W 582 BULB LED E14, T25, 4W 582 BULB LED, GX53, 8W 582 REFLECTOR LENS LED, GU10, ES111, 9W 583 REFLECTOR DIFFUSER LED, GU10, ES111, 9W 583 BULB VINTAGE LED, E27, 6W 584



STEP LED 565 OIA LED 565 BUSH 566 SPIKE LED 566 RUMI LED 567 PICCO LED 568



BULB VINTAGE LED, E27, 6W 584 BULB VINTAGE LED, E27, 6W 584 BULB VINTAGE LED, E27, 6W 584 BULB LED E14, C35, 6W 585 BULB LED E27, A60, 7W 585 BULB LED E27, A60, 10W 585



PAT LED 569 PAOLI 569 MON LED 569 CIRLET LED 569 ANA 570 AMELIA 571



BULB LED, E27, A60, 2W, 5 PC SET 585



TUBE LED T8 586



WATERPROOF
CONNECTOR
IP68 687



WATERPROOF
„Y” CONNECTOR
IP 68 687



MICROWAVE
SENSOR 587



48V DC
POWER
SUPPLY 588



24V DC
POWER
SUPPLY 588



HONEY
COMB 589



ACROBAT 589



BALLERINA 589

Nasze produkty to efekt dbałości o jakość i zamiłowania do nowatorskich rozwiązań, a sposób ich prezentowania jest wizytówką naszej pracy. Wszystkie zdjęcia i wizualizacje zamieszczone w tym katalogu są starannie dostosowane wyłącznie do jego parametrów. Prosimy o niekorzystanie z nich bez naszej wiedzy i zgody. Jeśli potrzebujesz materiałów graficznych do innych potrzeb, skontaktuj się z nami pod adresem marketing@nowodvorski.com

Wszelkie prawa do dysponowania materiałami zamieszczonymi w katalogu i decydowania o sposobie ich wykorzystania przysługują Nowodvorski Lighting sp. z o.o.

Our products are the result of our commitment to quality and passion for inventive solutions, and the way they are presented is a showcase of our work. All photos and visualizations in this catalog have been carefully tailored exclusively to its specifications. Please do not use them without our knowledge and consent. If you need graphic materials for other purposes, please contact us at marketing@nowodvorski.com.

All rights to manage the materials included in this catalog and decide on their use belong to Nowodvorski Lighting sp. z o.o.

Catalogue 2025/2026

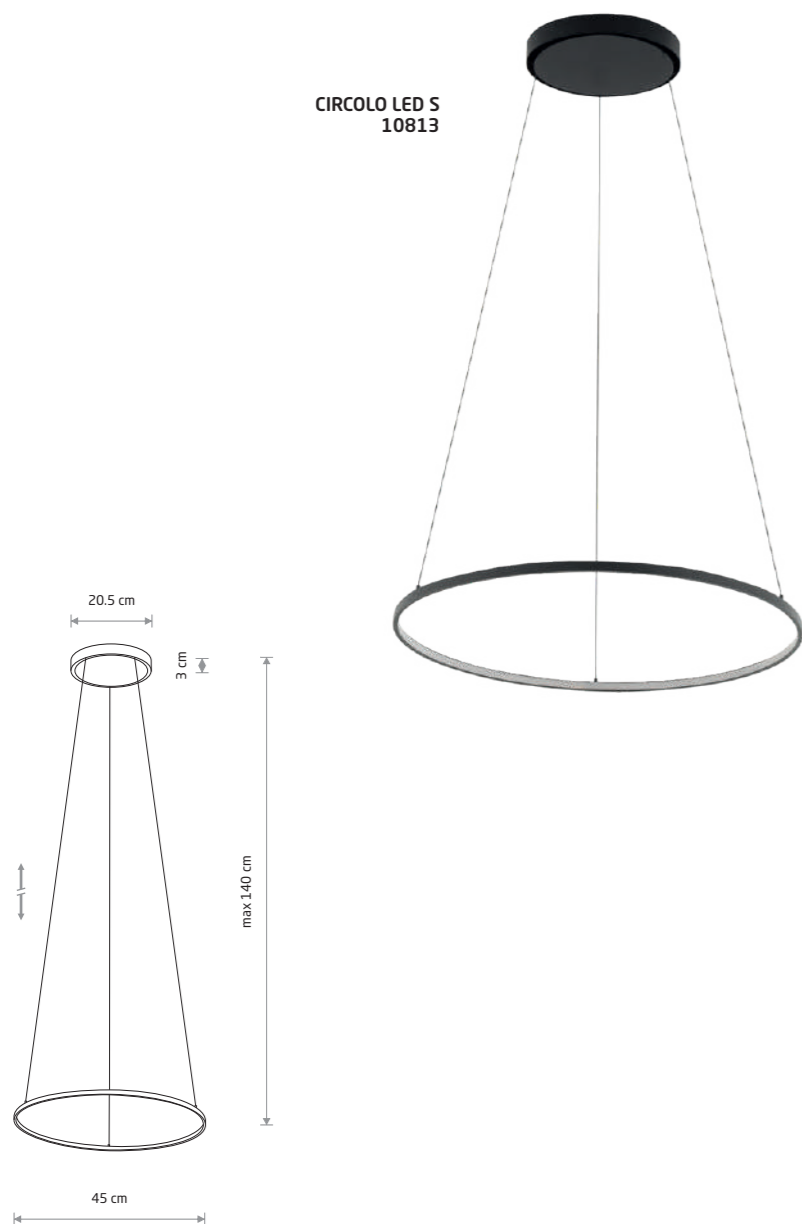

Collections

CIRCOLO LED S
10813

CIRCOLO LED S

painted aluminum, painted steel, plastic PC

■ 10813 3000K ■ 10863 4000K



CIRCOLO LED M

painted aluminum, painted steel, plastic PC

■ 10812 3000K ■ 10862 4000K

■ 11403 3000K ■ 11604 3000K

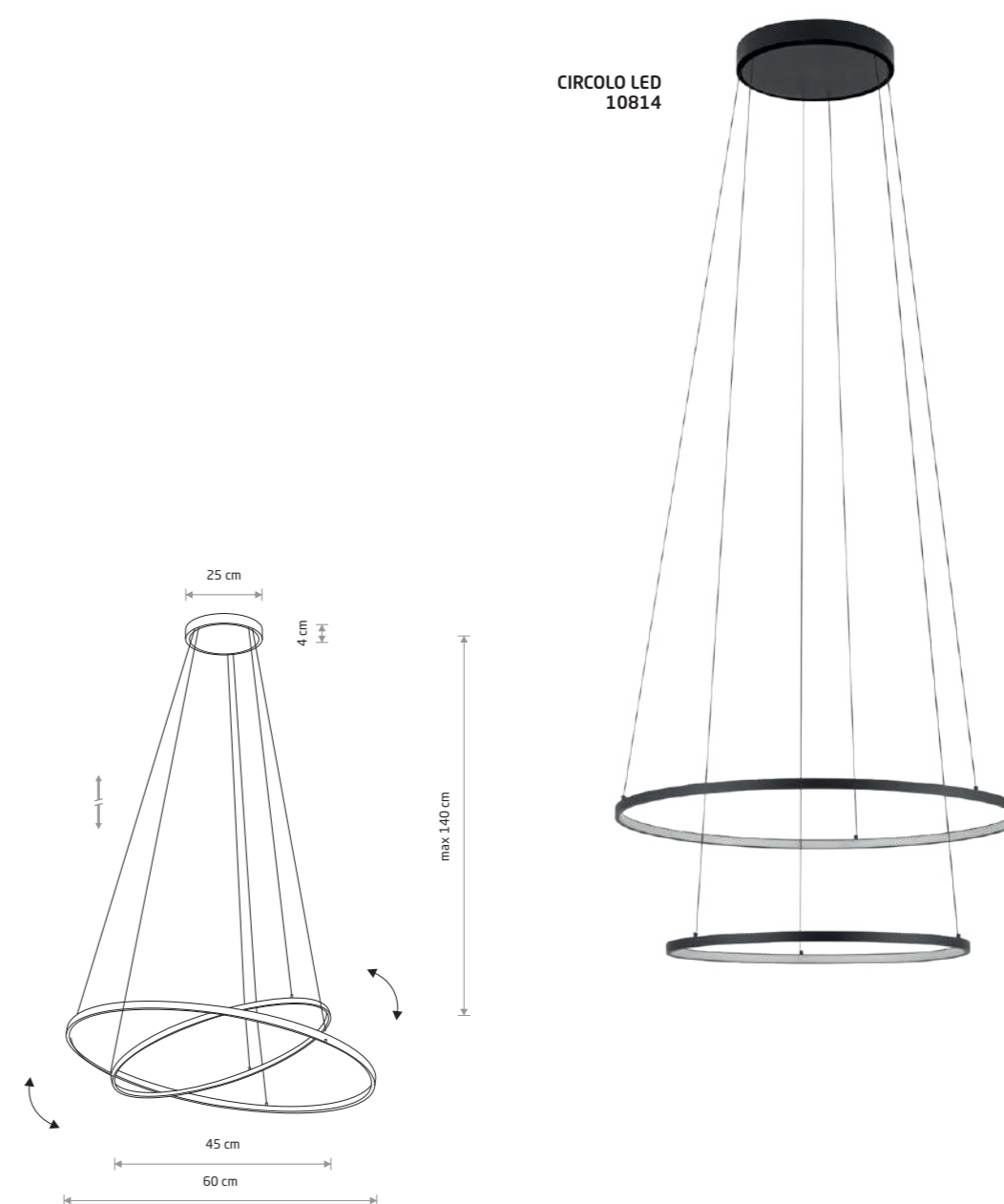
CIRCOLO LED
10814

CIRCOLO LED

painted aluminum, painted steel, plastic PC

■ 10814 3000K ■ 10864 4000K



CIRCOLO POWER LED

painted aluminum, painted steel, plastic PC

■ 11646 3000K ■ 11647 3000K



Item No.	Power	Colour temp.	Luminous flux	Beam angle	Colour Rendering Index (CRI)	Input	Safety type	Power factor	Ingress protection	Lifetime
10813	18W LED	3000K	560 lm	70°	>90	~220-230 V, 50/60 Hz	⊕	>0.5	IP20	30000h
10863	18W LED	4000K	600 lm	70°	>90	~220-230 V, 50/60 Hz	⊕	>0.5	IP20	30000h
10812	21W LED	3000K	660 lm	70°	>90	~220-230 V, 50/60 Hz	⊕	>0.5	IP20	30000h
10862	21W LED	4000K	700 lm	70°	>90	~220-230 V, 50/60 Hz	⊕	>0.5	IP20	30000h
11403	21W LED	3000K	660 lm	70°	>90	~220-230 V, 50/60 Hz	⊕	>0.5	IP20	30000h
11604	21W LED	3000K	660 lm	70°	>90	~220-230 V, 50/60 Hz	⊕	>0.5	IP20	30000h

Item No.	Power	Colour temp.	Luminous flux	Beam angle	Colour Rendering Index (CRI)	Input	Safety type	Power factor	Ingress protection	Lifetime
10814	35W LED	3000K	1200 lm	70°	>90	~220-230 V, 50/60 Hz	⊕	>0.5	IP20	30000h
10864	35W LED	4000K	1300 lm	70°	>90	~220-230 V, 50/60 Hz	⊕	>0.5	IP20	30000h
11646	67W LED	3000K	3700 lm	70°	>80	~220-230 V, 50/60 Hz	⊕	>0.9	IP20	30000h
11647	67W LED	3000K	3100 lm	70°	>80	~220-230 V, 50/60 Hz	⊕	>0.9	IP20	30000h

■ WHITE P004 RAL 9003 ■ SILK OLIVE P031 ■ BLACK P013 RAL 9005

■ WHITE P004 RAL 9003 ■ BLACK P013 RAL 9005



CIRCOLO LED 10867



CIRCOLO LED 10816

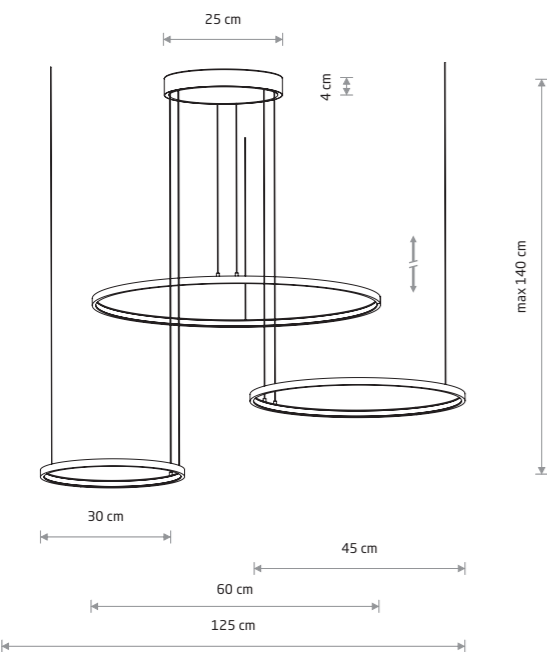

CIRCOLO POWER LED

painting aluminum, painting steel, plastic PC

■ 11649 3000K ■ 11648 3000K



CIRCOLO LED

painting aluminum, painting steel, plastic PC

■ 10817 3000K ■ 10867 4000K

■ 11398 3000K ■ 11602 3000K

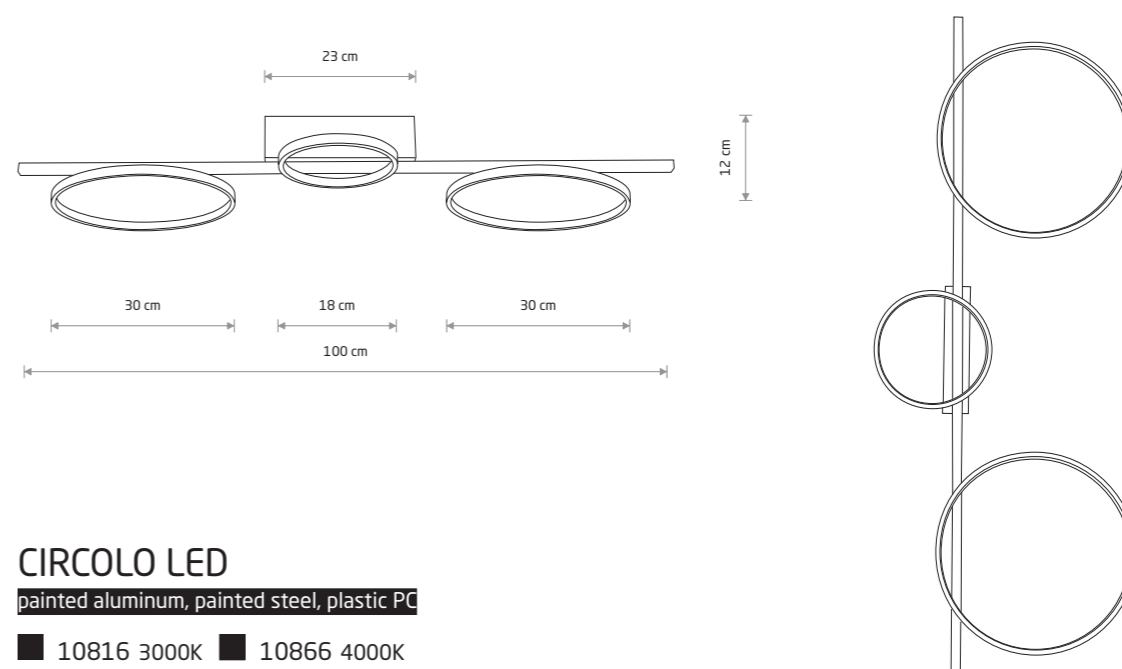

CIRCOLO LED

painting aluminum, painting steel, plastic PC

■ 10816 3000K ■ 10866 4000K



Item No.	Power	Colour temp.	Luminous flux	Beam angle	Colour Rendering Index (CRI)	Input	Safety type	Power factor	Ingress protection	Lifetime
10817	45W LED	3000K	1600 lm	70°	>90	~220-230 V, 50/60 Hz	⊕	>0.5	IP20	30000h
10867	45W LED	4000K	1800 lm	70°	>90	~220-230 V, 50/60 Hz	⊕	>0.5	IP20	30000h
11398	45W LED	3000K	1600 lm	70°	>90	~220-230 V, 50/60 Hz	⊕	>0.5	IP20	30000h
11602	45W LED	3000K	1600 lm	70°	>90	~220-230 V, 50/60 Hz	⊕	>0.5	IP20	30000h
11648	85W LED	3000K	3750 lm	70°	>80	~220-230 V, 50/60 Hz	⊕	>0.9	IP20	30000h
11649	85W LED	3000K	4600 lm	70°	>80	~220-230 V, 50/60 Hz	⊕	>0.9	IP20	30000h

Item No.	Power	Colour temp.	Luminous flux	Beam angle	Colour Rendering Index (CRI)	Input	Safety type	Power factor	Ingress protection	Lifetime
10816	33W LED	3000K	1100 lm	70°	>90	~220-230 V, 50/60 Hz	⊕	>0.5	IP20	30000h
10866	33W LED	4000K	1200 lm	70°	>90	~220-230 V, 50/60 Hz	⊕	>0.5	IP20	30000h

■ WHITE P004 RAL 9003 ■ SILK OLIVE P031 ■ BLACK P013 RAL 9005

■ BLACK P013 RAL 9005



CIRCOLO LED M
10815

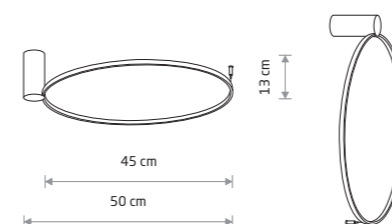

CIRCOLO LED S

■ painted aluminum, painted steel, plastic PC

■ 10928 3000K ■ 10930 4000K



CIRCOLO LED XS
10858

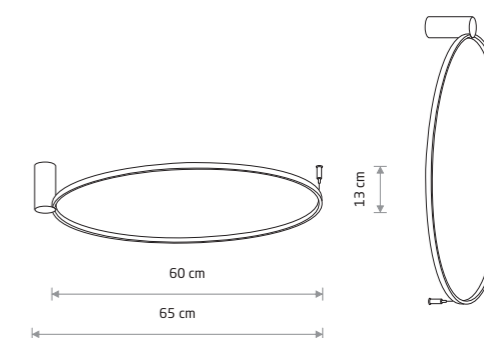
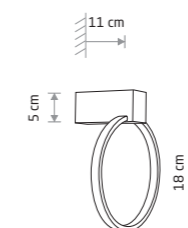

CIRCOLO LED M

■ painted aluminum, painted steel, plastic PC

■ 10815 3000K ■ 10865 4000K

■ 11402 3000K ■ 11603 3000K



CIRCOLO LED XS

■ painted aluminum, plastic PC

■ 10808 3000K ■ 10858 4000K

■ 11601 3000K



Item No.	Power	Colour temp.	Luminous flux	Beam angle	Colour Rendering Index (CRI)	Input	Safety type	Power factor	Ingress protection	Lifetime
10808	9W LED	3000K	190 lm	70°	>90	~220-230 V, 50/60 Hz	⊕	>0.5	IP20	30000h
10858	9W LED	4000K	200 lm	70°	>90	~220-230 V, 50/60 Hz	⊕	>0.5	IP20	30000h
10928	18W LED	3000K	560 lm	70°	>90	~220-230 V, 50/60 Hz	⊕	>0.5	IP20	30000h
10930	18W LED	4000K	600 lm	70°	>90	~220-230 V, 50/60 Hz	⊕	>0.5	IP20	30000h
10815	21W LED	3000K	660 lm	70°	>90	~220-230 V, 50/60 Hz	⊕	>0.5	IP20	30000h
10865	21W LED	4000K	700 lm	70°	>90	~220-230 V, 50/60 Hz	⊕	>0.5	IP20	30000h
11402	21W LED	3000K	660 lm	70°	>90	~220-230 V, 50/60 Hz	⊕	>0.5	IP20	30000h
11603	21W LED	3000K	660 lm	70°	>90	~220-230 V, 50/60 Hz	⊕	>0.5	IP20	30000h
11601	9W LED	3000K	190 lm	70°	>90	~220-230 V, 50/60 Hz	⊕	>0.5	IP20	30000h

CIRCOLO LED S
10810

CIRCOLO LED M
10811



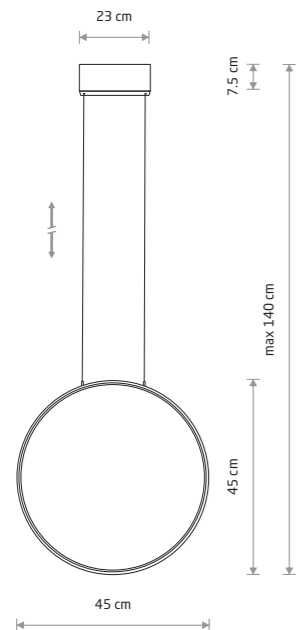

CIRCOLO LED S

■ painted aluminum, painted steel, plastic PC

■ 10810 3000K ■ 10860 4000K

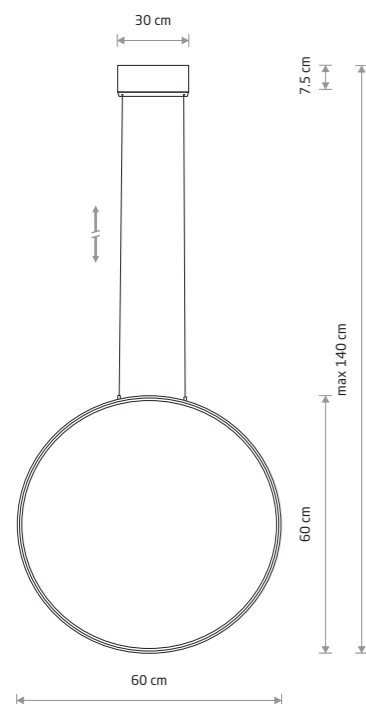

CIRCOLO LED M

■ painted aluminum, painted steel, plastic PC

■ 10811 3000K ■ 10861 4000K

■ 11401 3000K □ 11605 3000K



Item No.	Power	Colour temp.	Luminous flux	Beam angle	Colour Rendering Index (CRI)	Input	Safety type	Power factor	Ingress protection	Lifetime
10810	18W LED	3000K	560 lm	70°	>90	~220-230 V, 50/60 Hz	⊕	>0.5	IP20	30000h
10860	18W LED	4000K	600 lm	70°	>90	~220-230 V, 50/60 Hz	⊕	>0.5	IP20	30000h
10811	21W LED	3000K	660 lm	70°	>90	~220-230 V, 50/60 Hz	⊕	>0.5	IP20	30000h
10861	21W LED	4000K	700 lm	70°	>90	~220-230 V, 50/60 Hz	⊕	>0.5	IP20	30000h
11401	21W LED	3000K	660 lm	70°	>90	~220-230 V, 50/60 Hz	⊕	>0.5	IP20	30000h
11605	21W LED	3000K	660 lm	70°	>90	~220-230 V, 50/60 Hz	⊕	>0.5	IP20	30000h

■ BLACK P013 RAL 9005 ■ SILK OLIVE P031 □ WHITE P004 RAL 9003



CIRCOLO LED M
11605

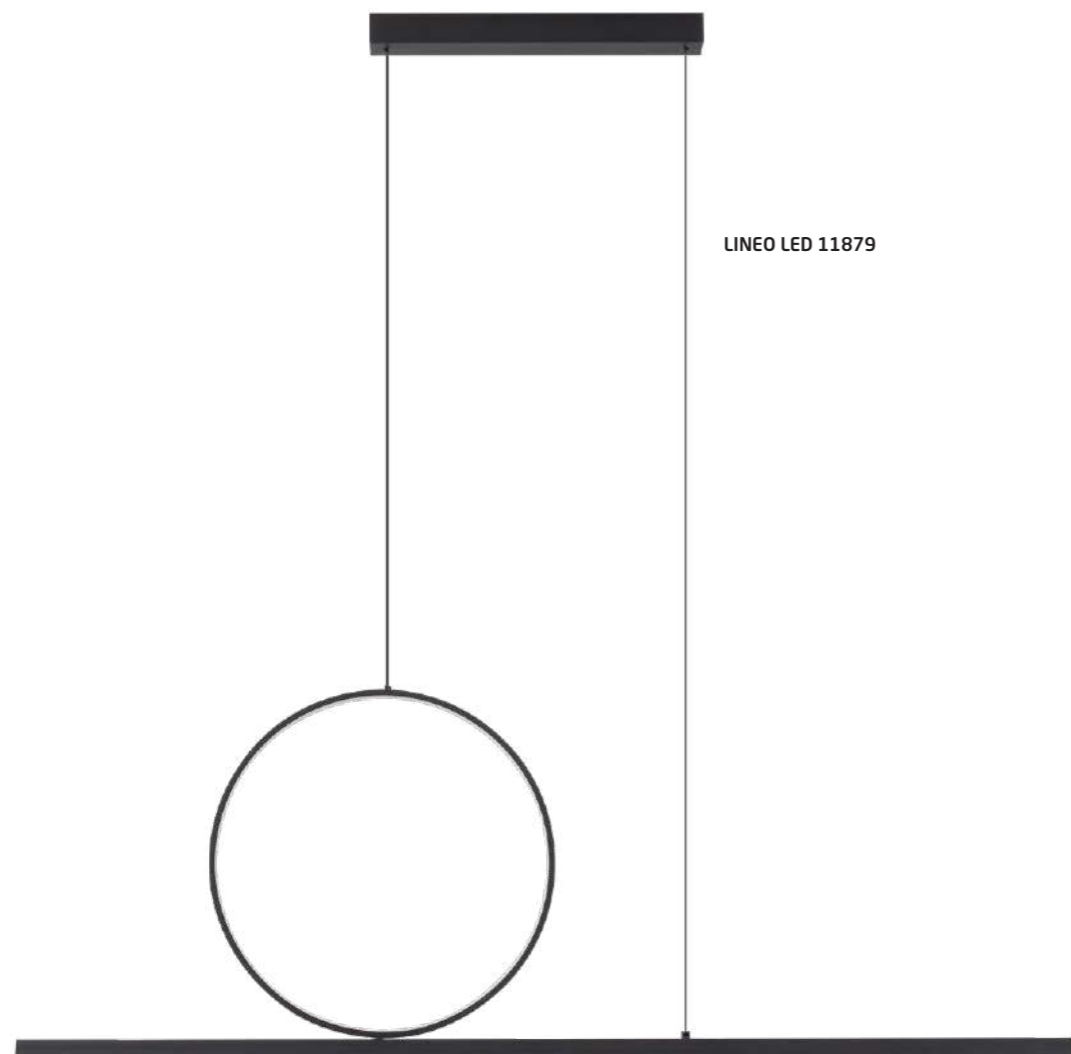

LINEO LED 11879

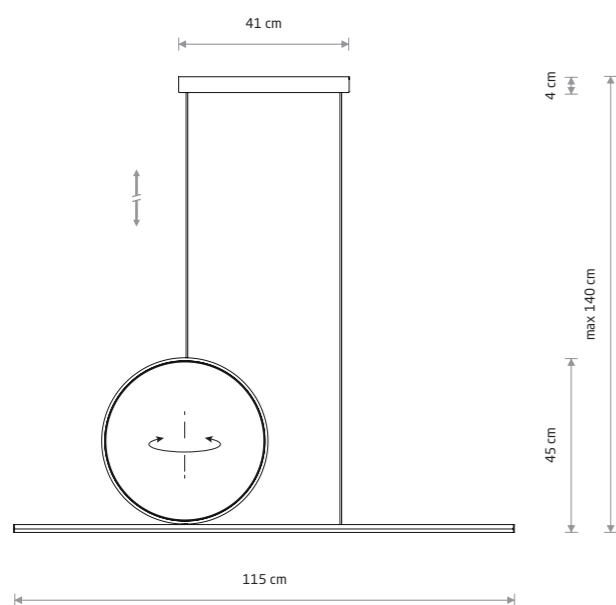

LINEO LED

■ painted aluminum, painted steel,
plastic PMMA, plastic PC

■ 11879 □ 11885



Item No.	Power	Colour temp.	Luminous flux	Beam angle	Colour Rendering Index (CRI)	Input	Safety type	Power factor	Ingress protection	Lifetime
11879	39W LED	3000K	1500 lm	100°	>80	~220-230 V, 50/60 Hz	⊕	>0.5	IP20	30000h
11885	39W LED	3000K	2100 lm	100°	>80	~220-230 V, 50/60 Hz	⊕	>0.5	IP20	30000h

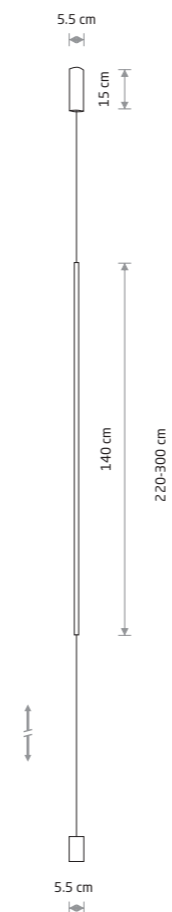

VERTIC LED

■ painted aluminum, painted steel, plastic PMMA

■ 10362 3000K ■ 10857 4000K

□ 11606 3000K □ 11607 4000K



Item No.	Power	Colour temp.	Luminous flux	Beam angle	Colour Rendering Index (CRI)	Input	Safety type	Power factor	Ingress protection	Lifetime
10362	19W LED	3000K	650 lm	100°	>90	~220-230 V, 50/60 Hz	⊕	>0.5	IP20	30000h
10857	19W LED	4000K	700 lm	100°	>90	~220-230 V, 50/60 Hz	⊕	>0.5	IP20	30000h
11606	19W LED	3000K	750 lm	100°	>90	~220-230 V, 50/60 Hz	⊕	>0.5	IP20	30000h
11607	19W LED	4000K	800 lm	100°	>90	~220-230 V, 50/60 Hz	⊕	>0.5	IP20	30000h

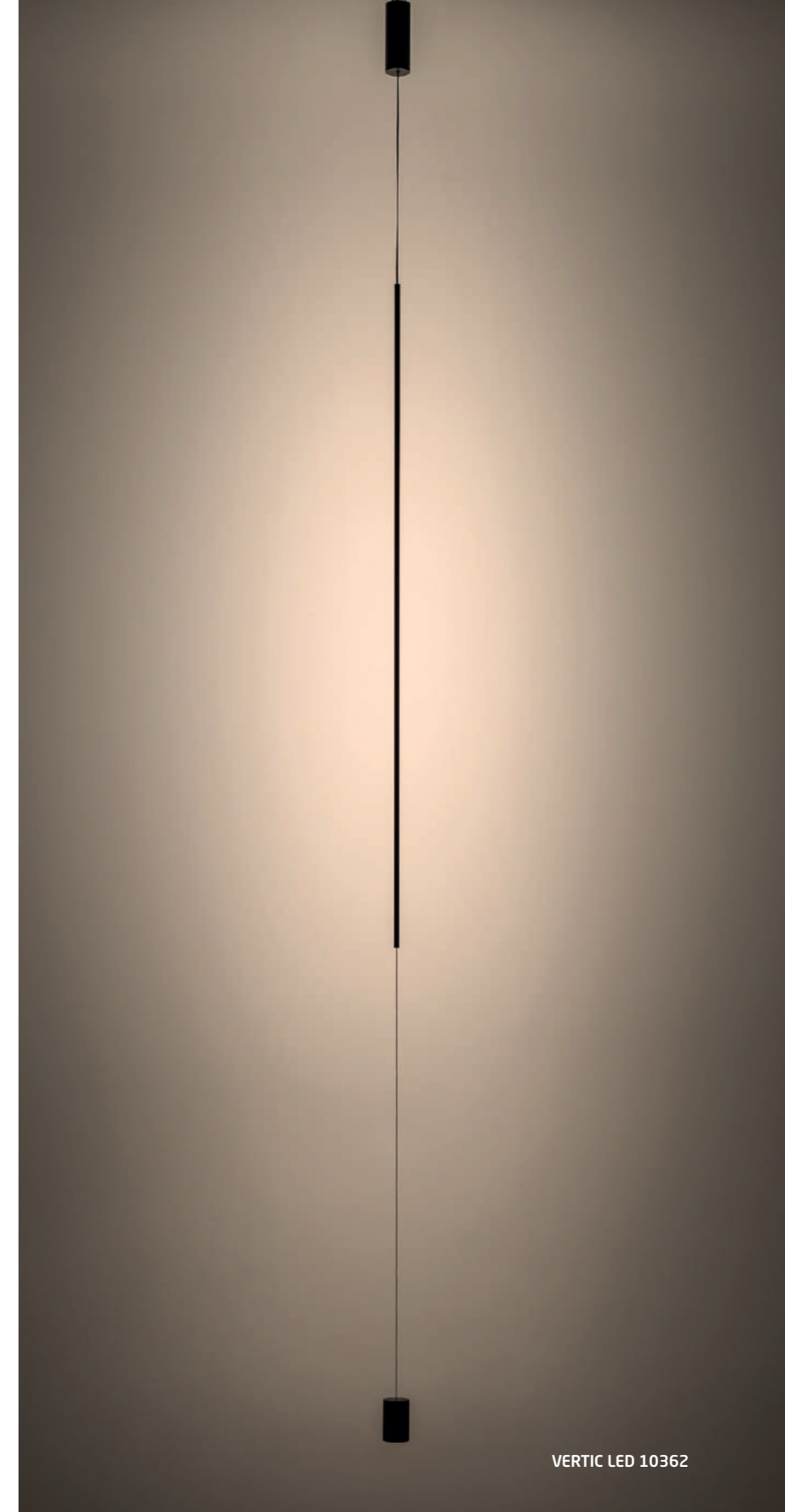

VERTIC LED 10362



GIAVELLOTTO LED S 11886

GIAVELLOTTO LED S
11886

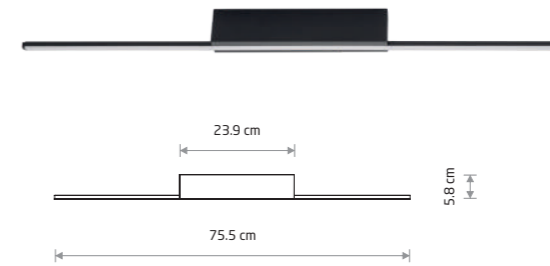

GIAVELLOTTO LED S
painted steel, painted aluminum, plastic PC

■ 11886



GIAVELLOTTO LED M
11887

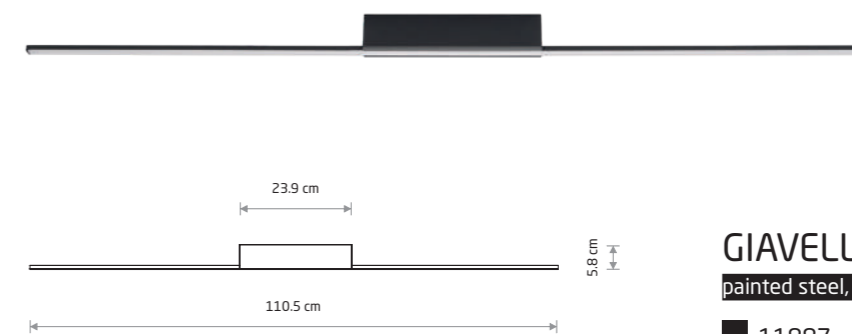

GIAVELLOTTO LED M
painted steel, painted aluminum, plastic PC

■ 11887



GIAVELLOTTO LED L
11888

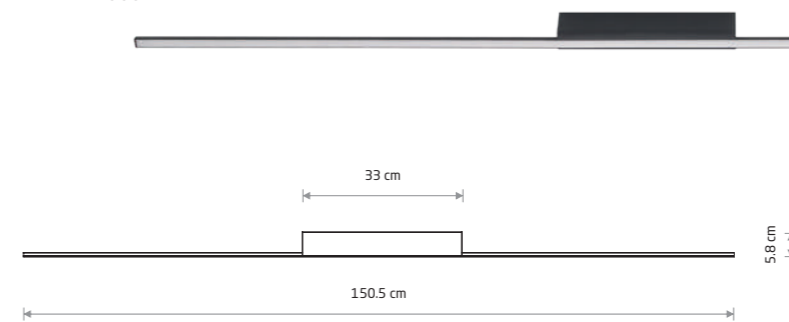

GIAVELLOTTO LED L
painted steel, painted aluminum, plastic PC

■ 11888



Item No.	Power	Colour temp.	Luminous flux	Beam angle	Colour Rendering Index (CRI)	Input	Safety type	Power factor	Ingress protection	Lifetime
11886	18W LED	3000K	1400 lm	120°	~220-230 V, 50/60 Hz	>80	⊕	>0.9	IP20	30000h
11887	25W LED	3000K	2000 lm	120°	~220-230 V, 50/60 Hz	>80	⊕	>0.9	IP20	30000h
11888	31W LED	3000K	2900 lm	120°	~220-230 V, 50/60 Hz	>80	⊕	>0.9	IP20	30000h

■ BLACK P013 RAL 9005

BAR LED M
11400

CIRCOLO LED M
11403

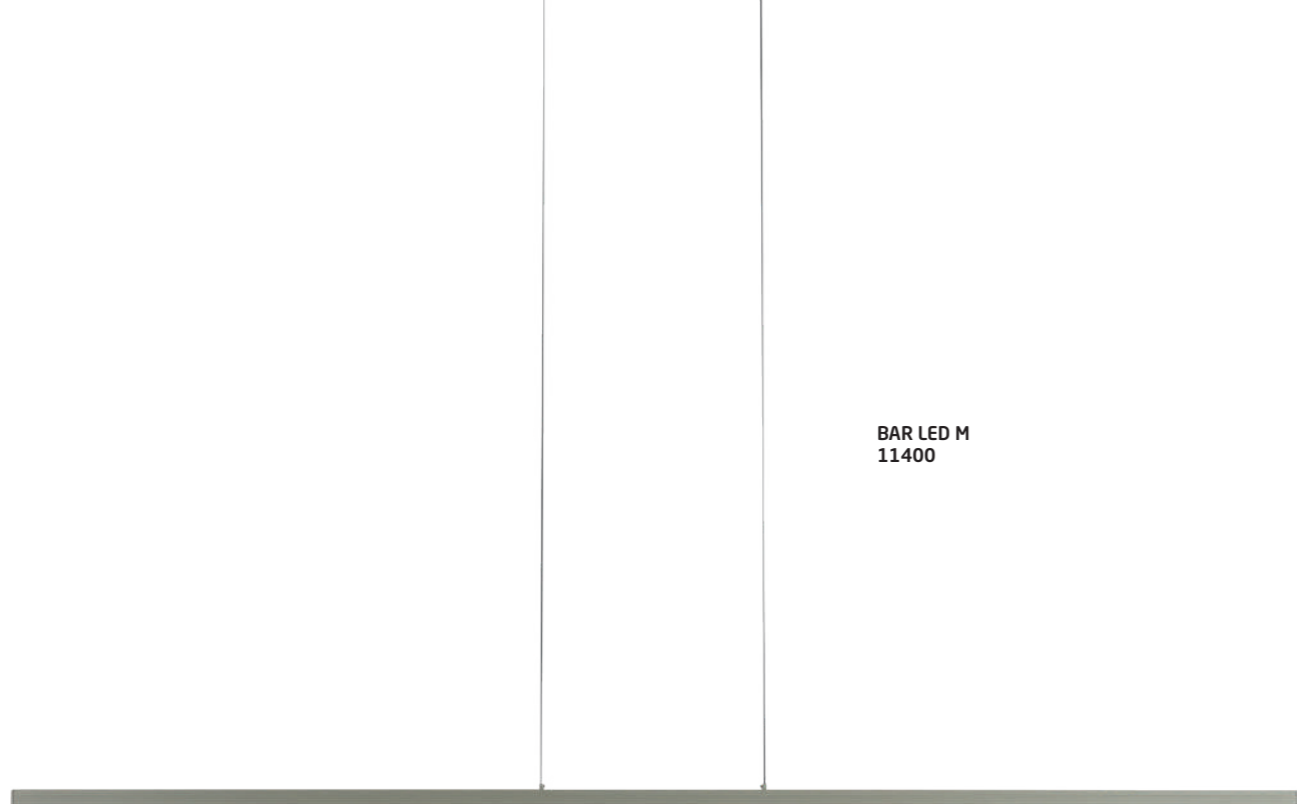

BAR LED M
11400

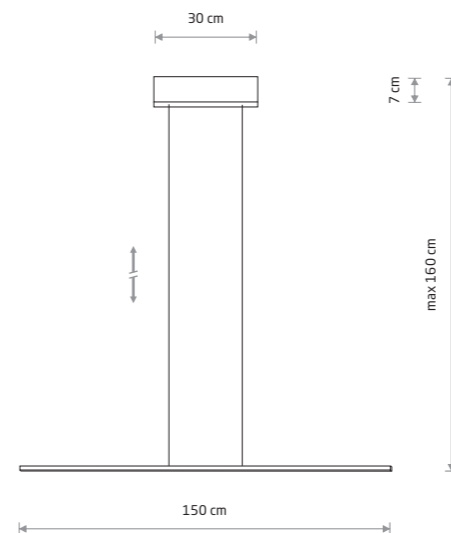

BAR LED M

■ painted aluminum, painted steel, plastic PMMA

■ 10364 3000K ■ 10848 4000K

□ 11581 3000K □ 11582 4000K

■ 11400 3000K

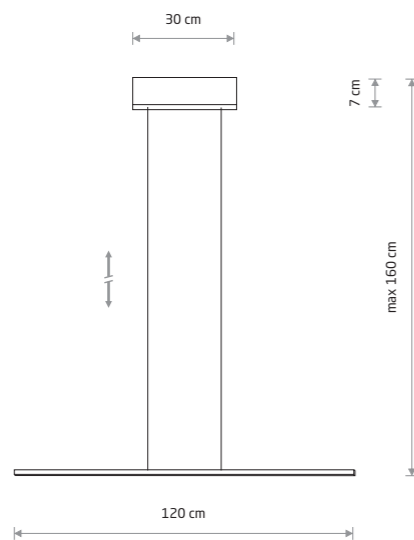

BAR LED S

■ painted aluminum, painted steel, plastic PMMA

□ 11583 3000K □ 11584 4000K

■ 10363 3000K ■ 10847 4000K

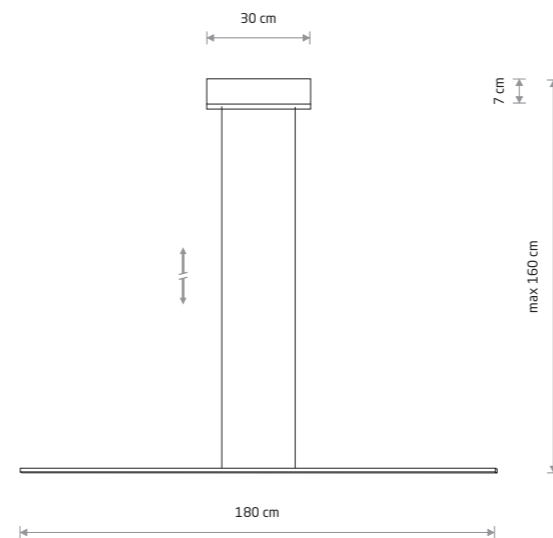

BAR LED L

■ painted aluminum, painted steel, plastic PMMA

■ 10365 3000K ■ 10850 4000K



Item No.	Power	Colour temp.	Luminous flux	Beam angle	Colour Rendering Index (CRI)	Input	Safety type	Power factor	Ingress protection	Lifetime
11583	27W LED	3000K	1700 lm	100°	>80	~220-230 V, 50/60 Hz	⊕	>0.5	IP20	30000h
11584	27W LED	4000K	1800 lm	100°	>80	~220-230 V, 50/60 Hz	⊕	>0.5	IP20	30000h
11581	32W LED	3000K	2000 lm	100°	>80	~220-230 V, 50/60 Hz	⊕	>0.5	IP20	30000h
10363	27W LED	3000K	1200 lm	100°	>80	~220-230 V, 50/60 Hz	⊕	>0.5	IP20	30000h
10847	27W LED	4000K	1300 lm	100°	>80	~220-230 V, 50/60 Hz	⊕	>0.5	IP20	30000h

Item No.	Power	Colour temp.	Luminous flux	Beam angle	Colour Rendering Index (CRI)	Input	Safety type	Power factor	Ingress protection	Lifetime
11582	32W LED	4000K	2100 lm	100°	>80	~220-230 V, 50/60 Hz	⊕	>0.5	IP20	30000h
11400	32W LED	3000K	1600 lm	100°	>80	~220-230 V, 50/60 Hz	⊕	>0.5	IP20	30000h
10364	32W LED	3000K	1600 lm	100°	>80	~220-230 V, 50/60 Hz	⊕	>0.5	IP20	30000h
10848	32W LED	4000K	1800 lm	100°	>80	~220-230 V, 50/60 Hz	⊕	>0.5	IP20	30000h
10365	40W LED	3000K	2200 lm	100°	>80	~220-230 V, 50/60 Hz	⊕	>0.5	IP20	30000h
10850	40W LED	4000K	2300 lm	100°	>80	~220-230 V, 50/60 Hz	⊕	>0.5	IP20	30000h

□ WHITE P004 RAL 9003 ■ BLACK P013 RAL 9005

□ WHITE P004 RAL 9003 ■ SILK OLIVE P031 ■ BLACK P013 RAL 9005

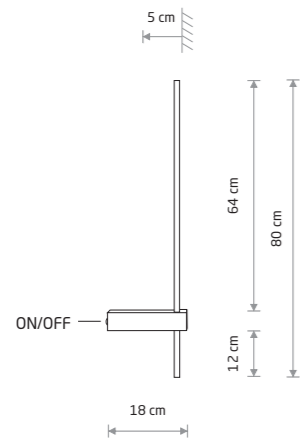

MOTIVE LED M

■ painted aluminum, plastic PC

■ 10311 3000K ■ 10852 4000K

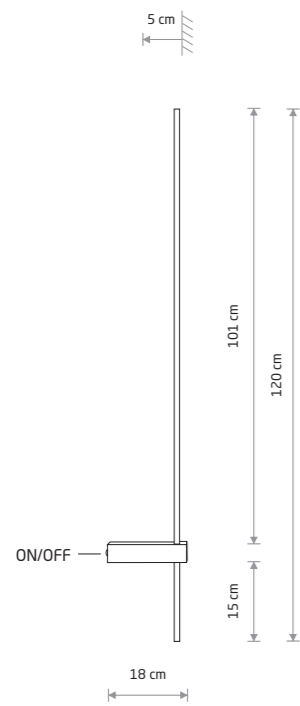

MOTIVE LED L

■ painted aluminum, plastic PC

■ 10313 3000K ■ 10851 4000K



Item No.	Power	Colour temp.	Luminous flux	Beam angle	Colour Rendering Index (CRI)	Input	Safety type	Power factor	Ingress protection	Lifetime
10311	11W LED	3000K	380 lm	100°	>90	~220-230 V, 50/60 Hz	⊕	>0.5	IP20	30000h
10852	11W LED	4000K	410 lm	100°	>90	~220-230 V, 50/60 Hz	⊕	>0.5	IP20	30000h
10313	16W LED	3000K	540 lm	100°	>90	~220-230 V, 50/60 Hz	⊕	>0.5	IP20	30000h
10851	16W LED	4000K	570 lm	100°	>90	~220-230 V, 50/60 Hz	⊕	>0.5	IP20	30000h

■ BLACK P013 RAL 9005



MOTIVE LED M 10311

MOTIVE LED L 10313



SABER LED M 10312

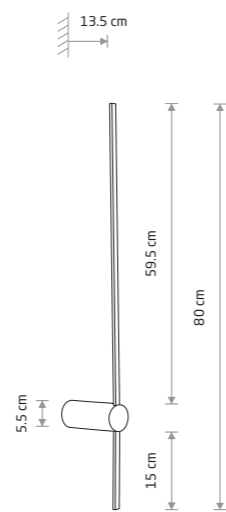

SABER LED M

painting aluminum, painting steel, plastic PC

- 10312 3000K ■ 10853 4000K
- 11378 3000K ■ 11380 4000K
- 11591 3000K □ 11592 4000K

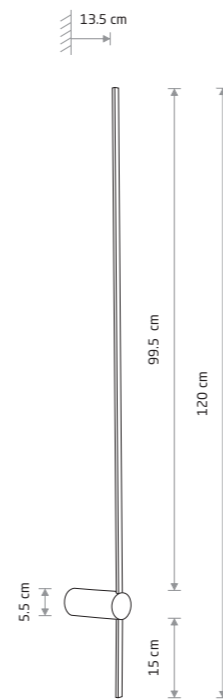

SABER LED L

painting aluminum, painting steel, plastic PC

- 10314 3000K ■ 10854 4000K
- 11381 3000K ■ 11382 4000K
- 11588 3000K □ 11590 4000K



SABER LED L
11381

SABER LED L
11588



Item No.	Power	Colour temp.	Luminous flux	Beam angle	Colour Rendering Index (CRI)	Input	Safety type	Power factor	Ingress protection	Lifetime
10312	11W LED	3000K	380 lm	100°	>90	~220-230 V, 50/60 Hz	⊕	>0.5	IP20	30000h
10853	11W LED	4000K	410 lm	100°	>90	~220-230 V, 50/60 Hz	⊕	>0.5	IP20	30000h
11378	11W LED	3000K	380 lm	100°	>90	~220-230 V, 50/60 Hz	⊕	>0.5	IP20	30000h
11380	11W LED	4000K	410 lm	100°	>90	~220-230 V, 50/60 Hz	⊕	>0.5	IP20	30000h
11591	11W LED	3000K	460 lm	100°	>90	~220-230 V, 50/60 Hz	⊕	>0.5	IP20	30000h
11592	11W LED	4000K	490 lm	100°	>90	~220-230 V, 50/60 Hz	⊕	>0.5	IP20	30000h

Item No.	Power	Colour temp.	Luminous flux	Beam angle	Colour Rendering Index (CRI)	Input	Safety type	Power factor	Ingress protection	Lifetime
10314	16W LED	3000K	540 lm	100°	>90	~220-230 V, 50/60 Hz	⊕	>0.5	IP20	30000h
10854	16W LED	4000K	570 lm	100°	>90	~220-230 V, 50/60 Hz	⊕	>0.5	IP20	30000h
11381	16W LED	3000K	540 lm	100°	>90	~220-230 V, 50/60 Hz	⊕	>0.5	IP20	30000h
11382	16W LED	4000K	570 lm	100°	>90	~220-230 V, 50/60 Hz	⊕	>0.5	IP20	30000h
11588	16W LED	3000K	740 lm	100°	>90	~220-230 V, 50/60 Hz	⊕	>0.5	IP20	30000h
11590	16W LED	4000K	790 lm	100°	>90	~220-230 V, 50/60 Hz	⊕	>0.5	IP20	30000h

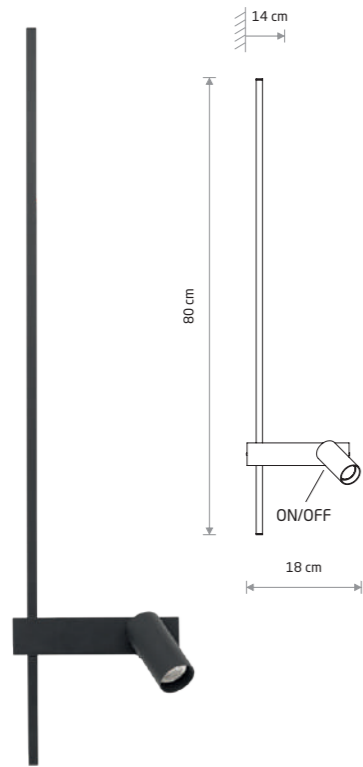

EASY LED LEFT
11425

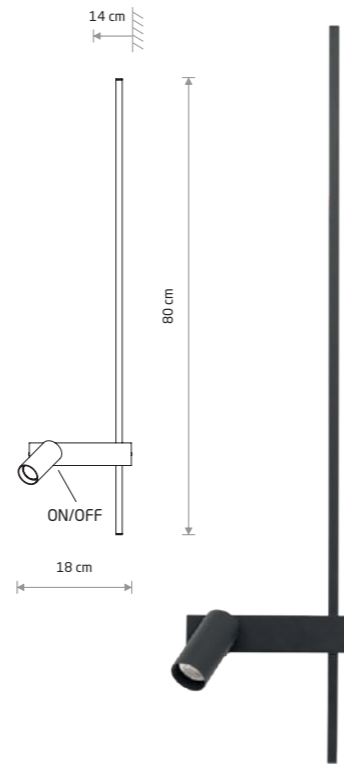

EASY LED RIGHT
11426



EASY LED LEFT

aluminum, painted steel, plastic PC

■ 11425 □ 11578

🔌 1x GU10 R35, max 10W only LED



EASY LED RIGHT

aluminum, painted steel, plastic PC

■ 11426 □ 11580

🔌 1x GU10 R35, max 10W only LED

Item No.	Power	Colour temp.	Luminous flux	Beam angle	Colour Rendering Index (CRI)	Input	Safety type	Power factor	Ingress protection	Lifetime
11425	11W LED	3000K	380 lm	100°	>90	~220-230 V, 50/60 Hz	⊕	>0.5	IP20	30000h
11578	11W LED	3000K	450 lm	100°	>90	~220-230 V, 50/60 Hz	⊕	>0.5	IP20	30000h
11426	11W LED	3000K	380 lm	100°	>90	~220-230 V, 50/60 Hz	⊕	>0.5	IP20	30000h
11580	11W LED	3000K	450 lm	100°	>90	~220-230 V, 50/60 Hz	⊕	>0.5	IP20	30000h

□ WHITE P004 RAL 9003 ■ BLACK P013 RAL 9005



EASY LED LEFT
11425

EASY LED RIGHT
11426

Visualisation by Iwona Ligęza



ARM LED L 10856

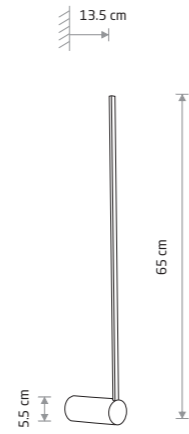

ARM LED M

■ painted aluminum, plastic PC

■ 10366 3000K ■ 10855 4000K

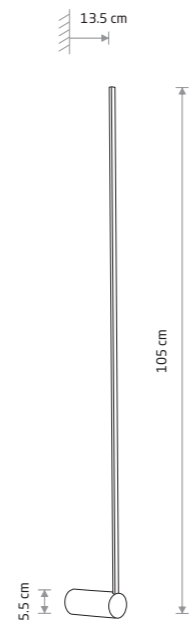

ARM LED L

■ painted aluminum, plastic PC

■ 10367 3000K ■ 10856 4000K



SLASH LED 11431

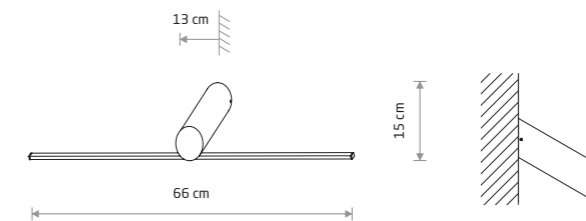

SLASH LED

■ painted aluminum, painted steel, plastic PC

■ 11431



Item No.	Power	Colour temp.	Luminous flux	Beam angle	Colour Rendering Index (CRI)	Input	Safety type	Power factor	Ingress protection	Lifetime
10366	10W LED	3000K	360 lm	100°	>90	~220-230 V, 50/60 Hz	⊕	>0.5	IP20	30000h
10855	10W LED	4000K	390 lm	100°	>90	~220-230 V, 50/60 Hz	⊕	>0.5	IP20	30000h
10367	14W LED	3000K	520 lm	100°	>90	~220-230 V, 50/60 Hz	⊕	>0.5	IP20	30000h
10856	14W LED	4000K	550 lm	100°	>90	~220-230 V, 50/60 Hz	⊕	>0.5	IP20	30000h

Item No.	Power	Colour temp.	Luminous flux	Beam angle	Colour Rendering Index (CRI)	Input	Safety type	Power factor	Ingress protection	Lifetime
11431	10W LED	3000K	360 lm	100°	>90	~220-230 V, 50/60 Hz	⊕	>0.5	IP20	30000h



SPIN LED M 10370

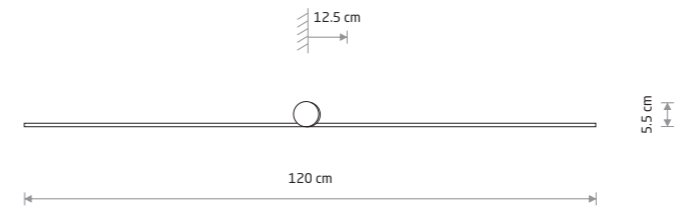
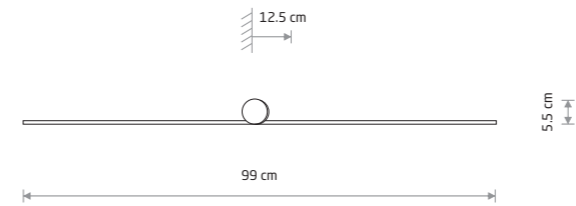
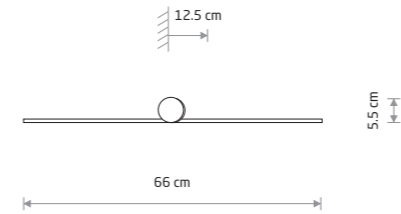

SPIN LED S

■ painted aluminum, painted steel, plastic PC

- 10368 3000K ■ 10620 4000K
- 11587 3000K



SPIN LED M

■ painted aluminum, painted steel, plastic PC

- 10370 3000K ■ 10621 4000K
- 11586 3000K



SPIN LED L

■ painted aluminum, painted steel, plastic PC

- 10371 3000K ■ 10622 4000K
- 11585 3000K



Item No.	Power	Colour temp.	Luminous flux	Beam angle	Colour Rendering Index (CRI)	Input	Safety type	Power factor	Ingress protection	Lifetime
10368	10W LED	3000K	360 lm	100°	>90	~220-230 V, 50/60 Hz	⊕	>0.5	IP20	30000h
10620	10W LED	4000K	390 lm	100°	>90	~220-230 V, 50/60 Hz	⊕	>0.5	IP20	30000h
10370	14W LED	3000K	520 lm	100°	>90	~220-230 V, 50/60 Hz	⊕	>0.5	IP20	30000h
10621	14W LED	4000K	550 lm	100°	>90	~220-230 V, 50/60 Hz	⊕	>0.5	IP20	30000h
10371	16W LED	3000K	600 lm	100°	>90	~220-230 V, 50/60 Hz	⊕	>0.5	IP20	30000h
10622	16W LED	4000K	630 lm	100°	>90	~220-230 V, 50/60 Hz	⊕	>0.5	IP20	30000h
11587	10W LED	3000K	400 lm	100°	>90	~220-230 V, 50/60 Hz	⊕	>0.5	IP20	30000h
11586	14W LED	3000K	650 lm	100°	>90	~220-230 V, 50/60 Hz	⊕	>0.5	IP20	30000h
11585	16W LED	3000K	750 lm	100°	>90	~220-230 V, 50/60 Hz	⊕	>0.5	IP20	30000h

□ WHITE P004 RAL 9003 ■ BLACK P013 RAL 9005

IMPULSE LED M 8116

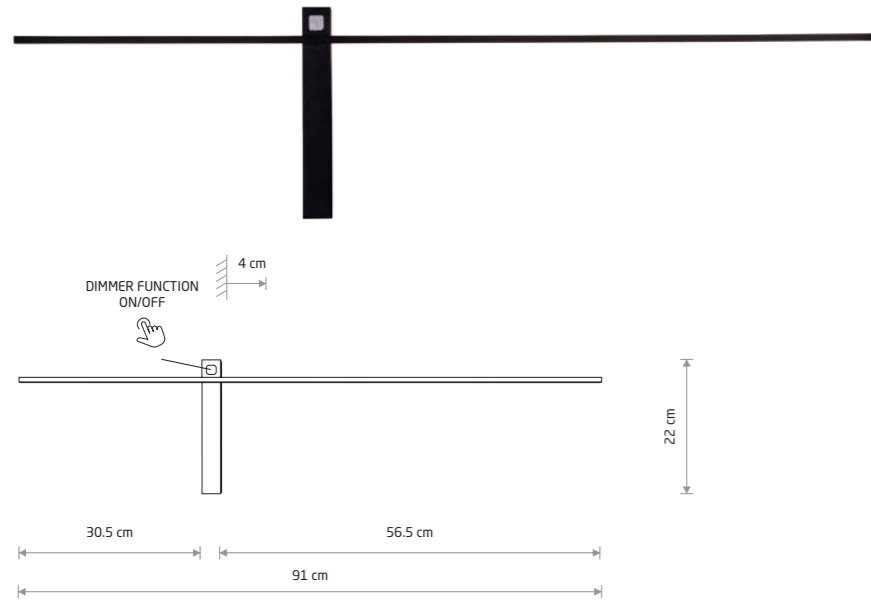

IMPULSE LED M
painted aluminum, plastic PC

■ 8116



IMPULSE LED S 8115

IMPULSE LED L 8117

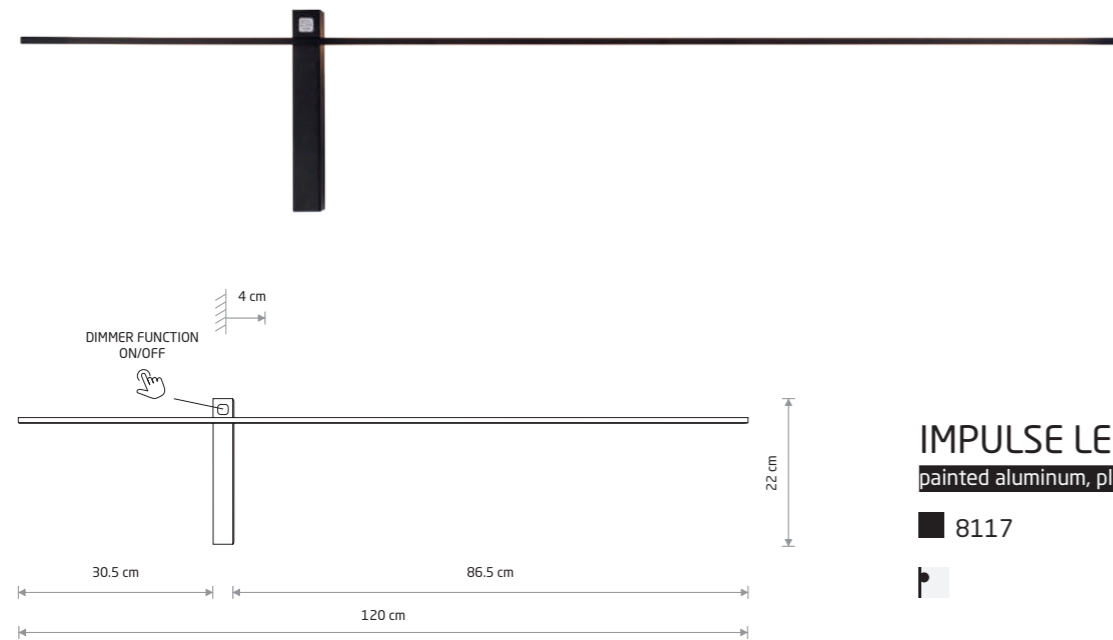

IMPULSE LED L
painted aluminum, plastic PC

■ 8117

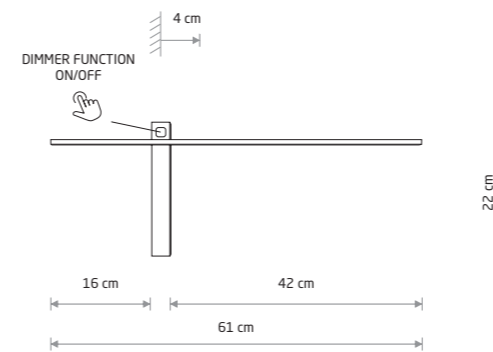

IMPULSE LED S
painted aluminum, plastic PC

■ 8115



Item No.	Power	Colour temp.	Luminous flux	Beam angle	Colour Rendering Index (CRI)	Input	Safety type	Power factor	Ingress protection	Lifetime
8115	6W LED	3000K	200 lm	120°	≥80	~220-230 V, 50/60 Hz	□	>0.5	IP23	30000h
8116	10W LED	3000K	350 lm	120°	≥80	~220-230 V, 50/60 Hz	□	>0.5	IP23	30000h
8117	15W LED	3000K	500 lm	120°	≥80	~220-230 V, 50/60 Hz	□	>0.5	IP23	30000h



VAN GOGH LED S 10286

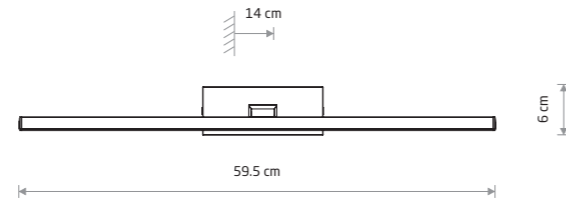
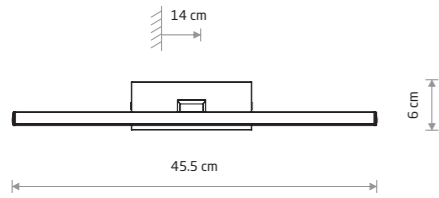

VAN GOGH LED S

Painted aluminum, plastic PC

10289 10292 10286



VAN GOGH LED M

Painted aluminum, plastic PC

10288 10291 10285

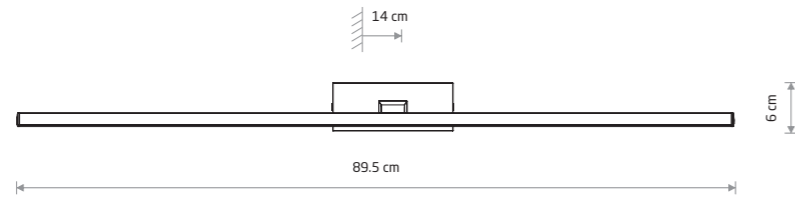

VAN GOGH LED L

Painted aluminum, plastic PC

10287 10290 10284

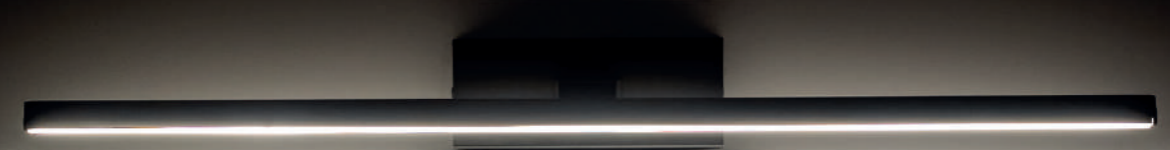

VAN GOGH LED S 10286

Item No.	Power	Colour temp.	Luminous flux	Beam angle	Colour Rendering Index (CRI)	Input	Safety type	Power factor	Ingress protection	Lifetime
10289	9W LED	3000K	370 lm	120°	≥ 80	~220-230 V, 50/60 Hz	⊕	>0.5	IP20	30000h
10292	9W LED	3000K	430 lm	120°	≥ 80	~220-230 V, 50/60 Hz	⊕	>0.5	IP20	30000h
10286	9W LED	3000K	290 lm	120°	≥ 80	~220-230 V, 50/60 Hz	⊕	>0.5	IP20	30000h
10288	13W LED	3000K	490 lm	120°	≥ 80	~220-230 V, 50/60 Hz	⊕	>0.5	IP20	30000h
10291	13W LED	3000K	640 lm	120°	≥ 80	~220-230 V, 50/60 Hz	⊕	>0.5	IP20	30000h
10285	13W LED	3000K	430 lm	120°	≥ 80	~220-230 V, 50/60 Hz	⊕	>0.5	IP20	30000h
10287	18W LED	3000K	800 lm	120°	≥ 80	~220-230 V, 50/60 Hz	⊕	>0.5	IP20	30000h
10290	18W LED	3000K	940 lm	120°	≥ 80	~220-230 V, 50/60 Hz	⊕	>0.5	IP20	30000h
10284	18W LED	3000K	650 lm	120°	≥ 80	~220-230 V, 50/60 Hz	⊕	>0.5	IP20	30000h

BLACK WHITE CHROME

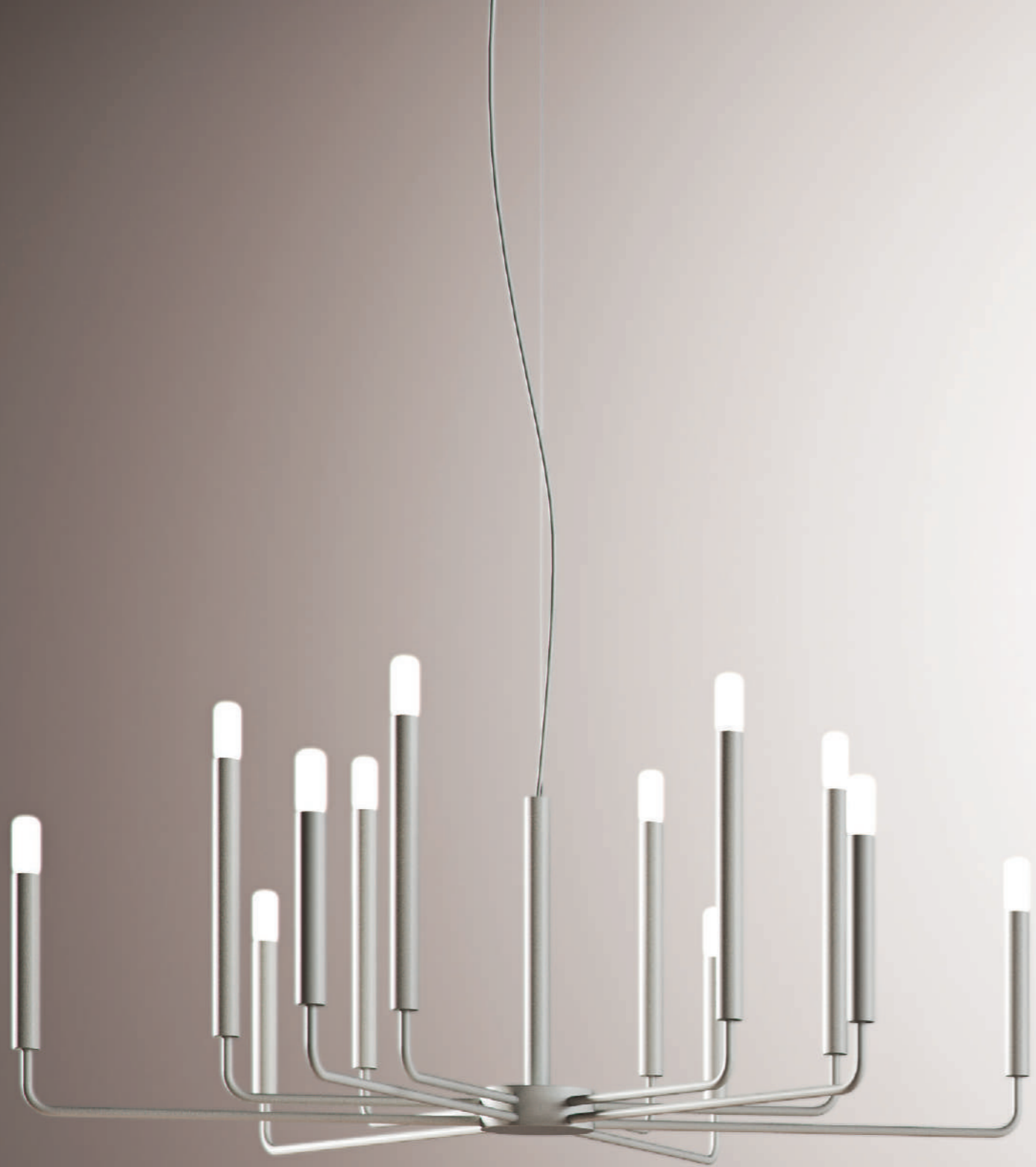



ORTO B 11464

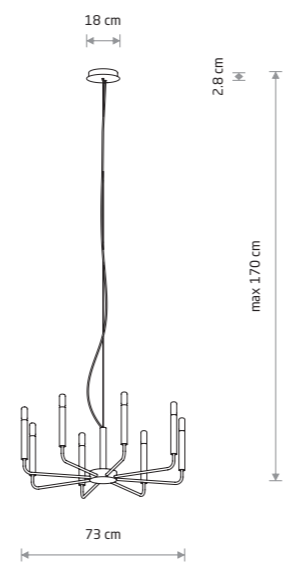

ORTO

■ painted steel

■ 11460 ■ 11461

● 8xE14, max 10W only LED

● BULB LED E14, T25, 4W

□ 11525 3000K

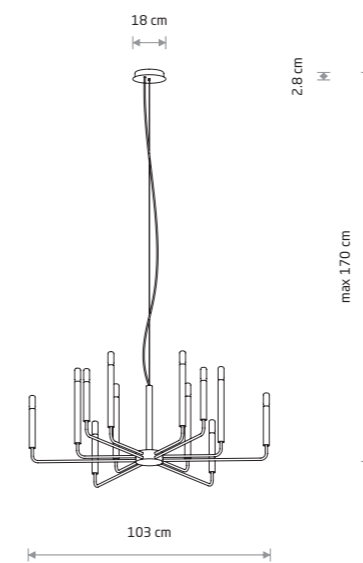

ORTO A

■ painted steel

■ 11462 ■ 11463

● 12xE14, max 10W only LED

● BULB LED E14, T25, 4W

□ 11525 3000K

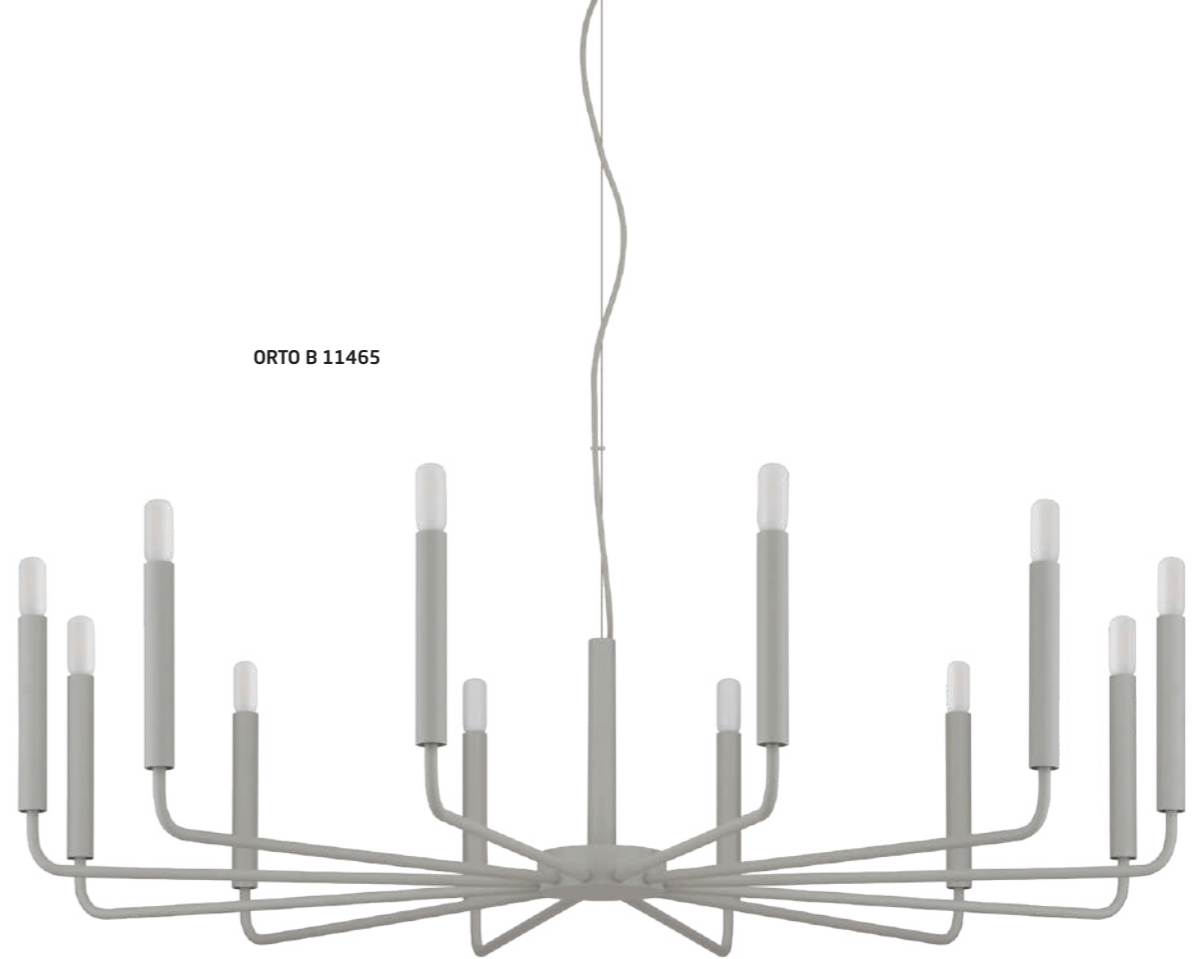

ORTO B 11465

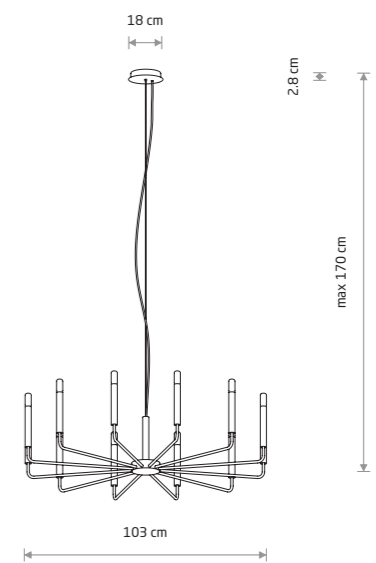

ORTO B

■ painted steel

■ 11464 ■ 11465

● 12xE14, max 10W only LED

● BULB LED E14, T25, 4W

□ 11525 3000K

■ BLACK P013 RAL 9005 ■ SILK GRAY P026 RAL 7044



LASER 490 10705

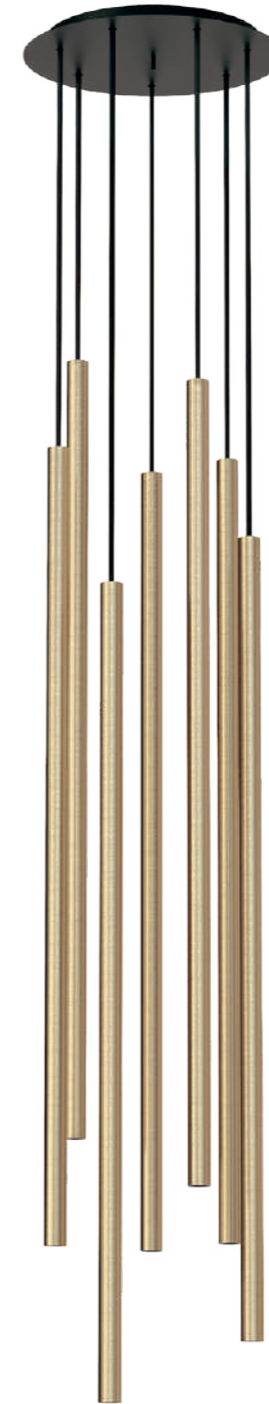

LASER 1000 7668

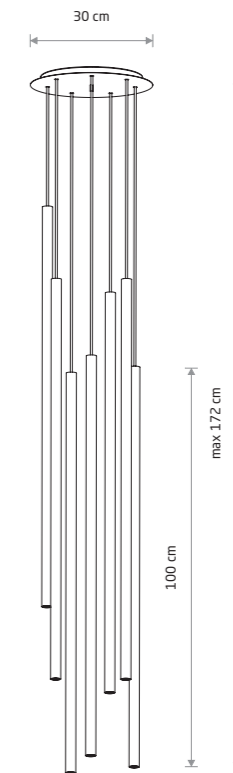
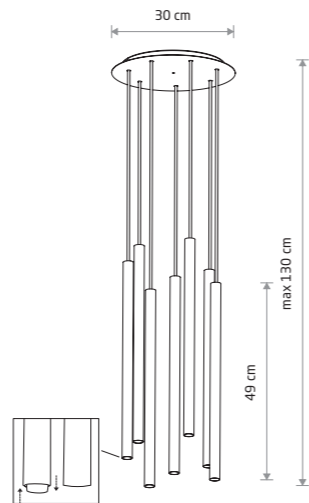
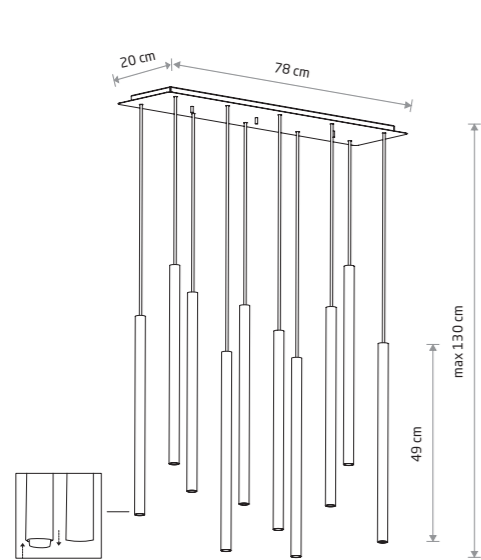

LASER 490

■ painted steel

- 8922 ■ 8923 ■ 10705

● 10xG9, max 10W only LED

■ solid brass, painted steel

- 8924

● 10xG9, max 10W only LED

LASER 490

■ painted steel

- 8918 ■ 8920 ■ 10704

● 7xG9, max 10W only LED

■ solid brass, painted steel

- 8921

● 7xG9, max 10W only LED

LASER 1000

■ painted steel

- 7667

● 7xG9, max 10W only LED

■ solid brass, painted steel

- 7668

● 7xG9, max 10W only LED



LASER 490 10453

LASER 490

painting steel

- 10451
- 10452
- 10453

1xG9, max 10W only LED

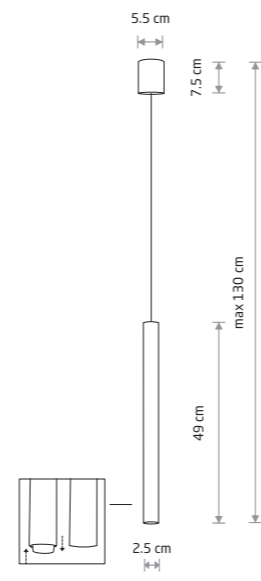
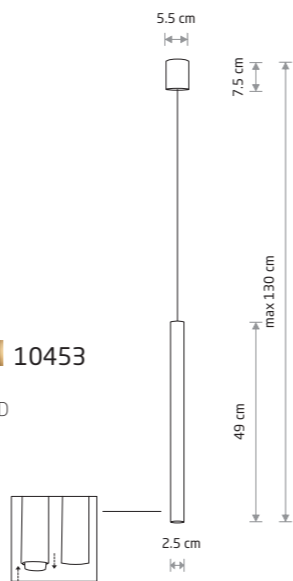

LASER 490

painting steel

- 8796
- 8797

1xG9, max 10W only LED

solid brass, painting steel

- 8798

1xG9, max 10W only LED



LASER 490 8796

LASER 750 8433

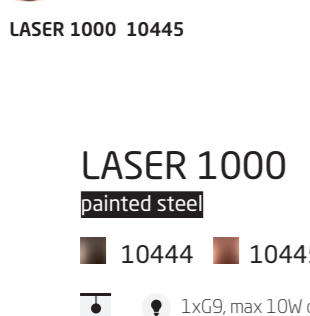

LASER 1000 10445

LASER 1000

painting steel

- 10444
- 10445
- 10446

1xG9, max 10W only LED

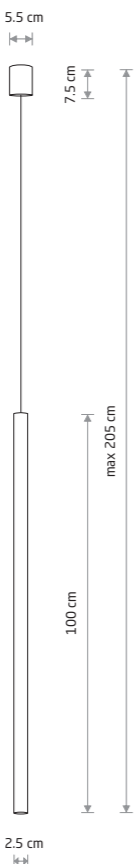

LASER 750

painting steel

- 10447
- 10448
- 10450

1xG9, max 10W only LED

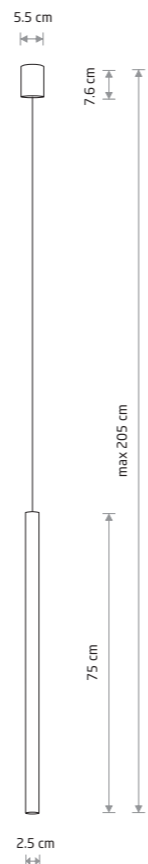

LASER 750

painting steel

- 8432
- 8433

1xG9, max 10W only LED

solid brass, painting steel

- 8431

1xG9, max 10W only LED

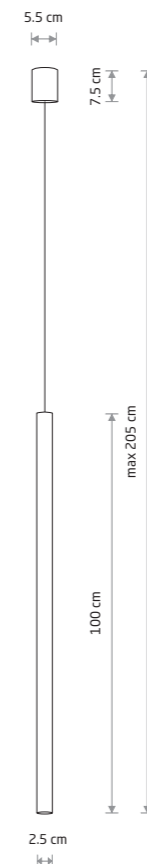

LASER 1000

painting steel

- 8435
- 8436

1xG9, max 10W only LED

solid brass, painting steel

- 8434

1xG9, max 10W only LED

LASER 1000 8434



LASER 750 10910

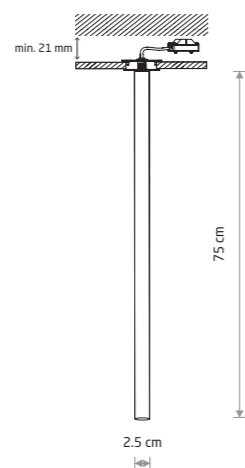

LASER 750

painting steel

10907 10910

1xG9, max 10W only LED



STALACTITE 9054



STALACTITE 8352



LASER 900 10915

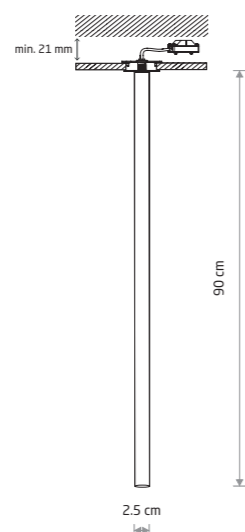

LASER 900

painting steel

10913 10915

1xG9, max 10W only LED

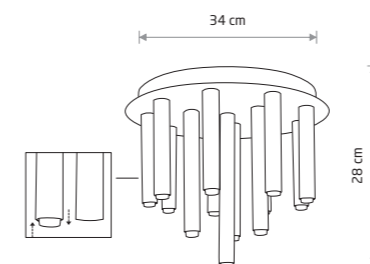

STALACTITE

painting steel

8355

13xG9, max 10W only LED

solid brass, painting steel

9054

13xG9, max 10W only LED

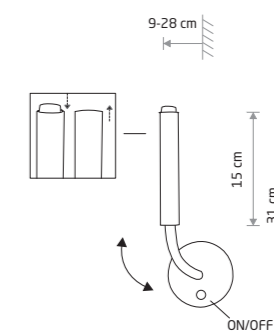

STALACTITE

painting steel, flexible stem

8351

1xG9, max 10W only LED

solid brass, painting steel, flexible stem

8352

1xG9, max 10W only LED



LASER WALL L 11814

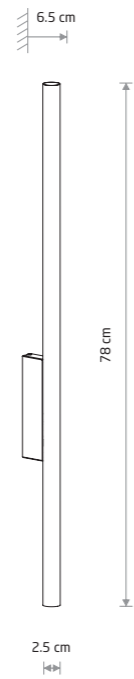

LASER WALL L

painted steel

11813 11812

11814 11815

2xG9, max 10W only LED

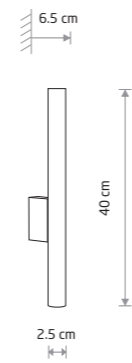

LASER WALL

painted steel

8048 8047 10562

10564 10563

2xG9, max 10W only LED

solid brass, painted steel

8308

2xG9, max 10W only LED

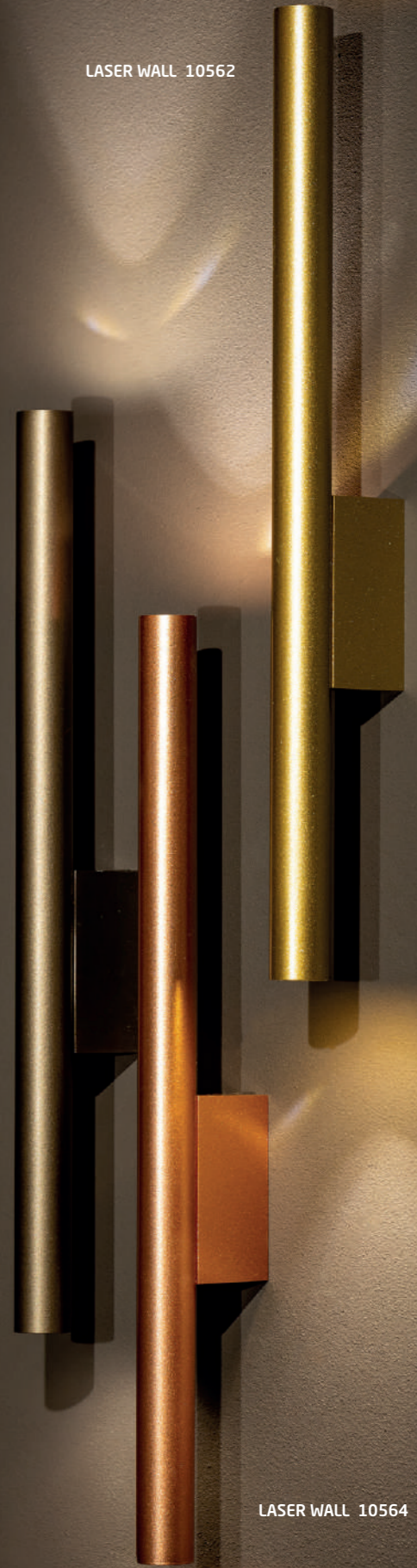

LASER WALL 10562

LASER WALL 10563

LASER WALL 10564







FOURTY
11447

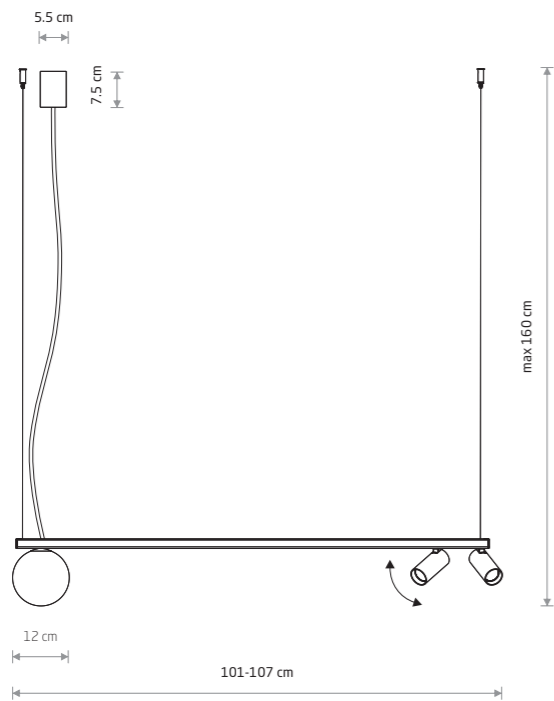

FOURTY
painted aluminum, glass, painted steel

- 11447 □ 11445
- 11450 ■ 11471
- 2xGU10 R35, 1xG9 max 10W only LED
- BULB LED G9, 4W
- 7503 3000K □ 7504 4000K

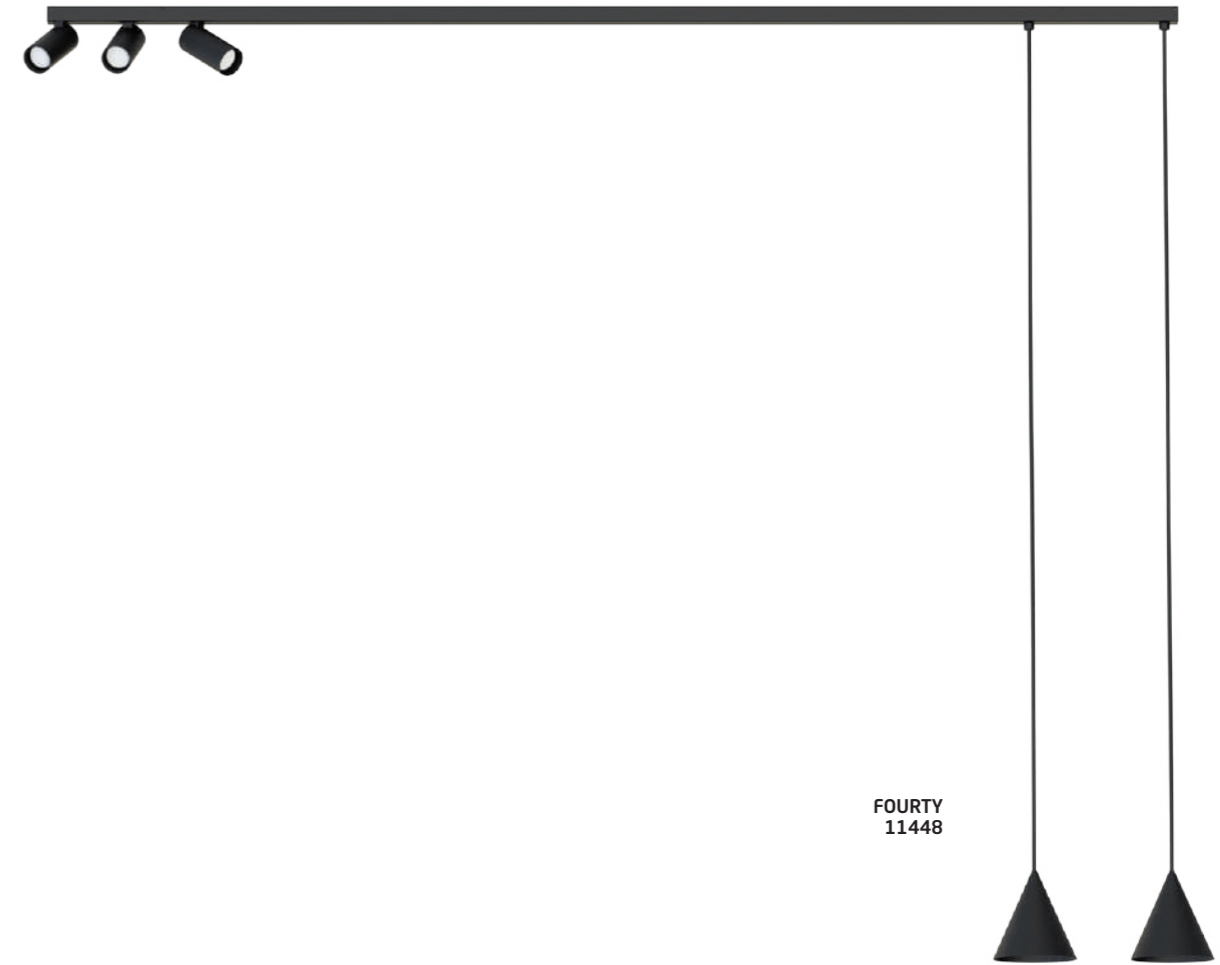

FOURTY
11448

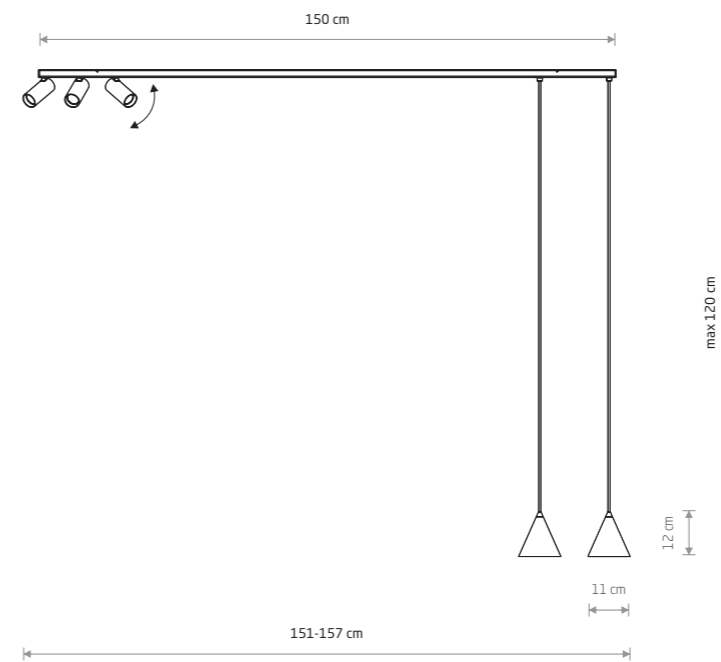

FOURTY
painted aluminum, painted steel

- 11448 □ 11446
- 11451 ■ 11472
- 5xGU10 R35, max 10W only LED
- 2xGU10 R50, 3xGU10 R35 max 10 W only LED

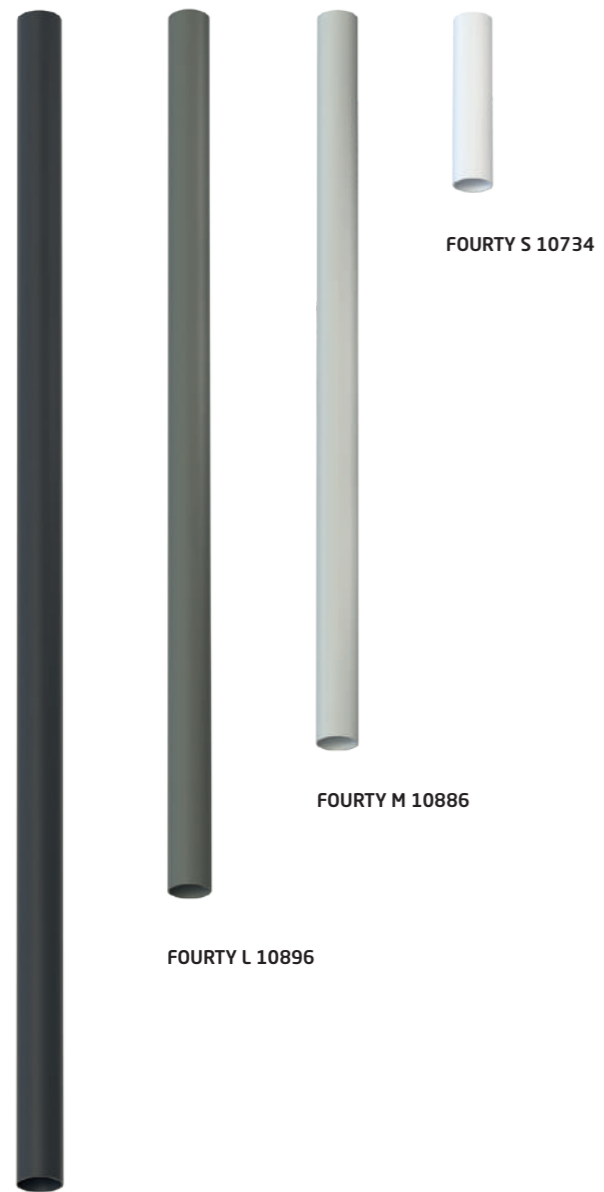

FOURTY S
 painted steel

10734 10735
 10883 10884

1xGU10 R35, max 10W only LED

solid brass

10882

1xGU10 R35, max 10W only LED

4 cm
 18.5 cm

FOURTY M
 painted aluminum

10820 10821
 10886 10887

1xGU10 R35, max 10W only LED

solid brass

10885

1xGU10 R35, max 10W only LED

4 cm
 75 cm

FOURTY XL
 painted aluminum

10824 10825
 10898 10899

1xGU10 R35, max 10W only LED

solid brass

10897

1xGU10 R35, max 10W only LED

4 cm
 110 cm

FOURTY L
 painted aluminum

10822 10823
 10895 10896

1xGU10 R35, max 10W only LED

solid brass

10894

1xGU10 R35, max 10W only LED

4 cm
 90 cm

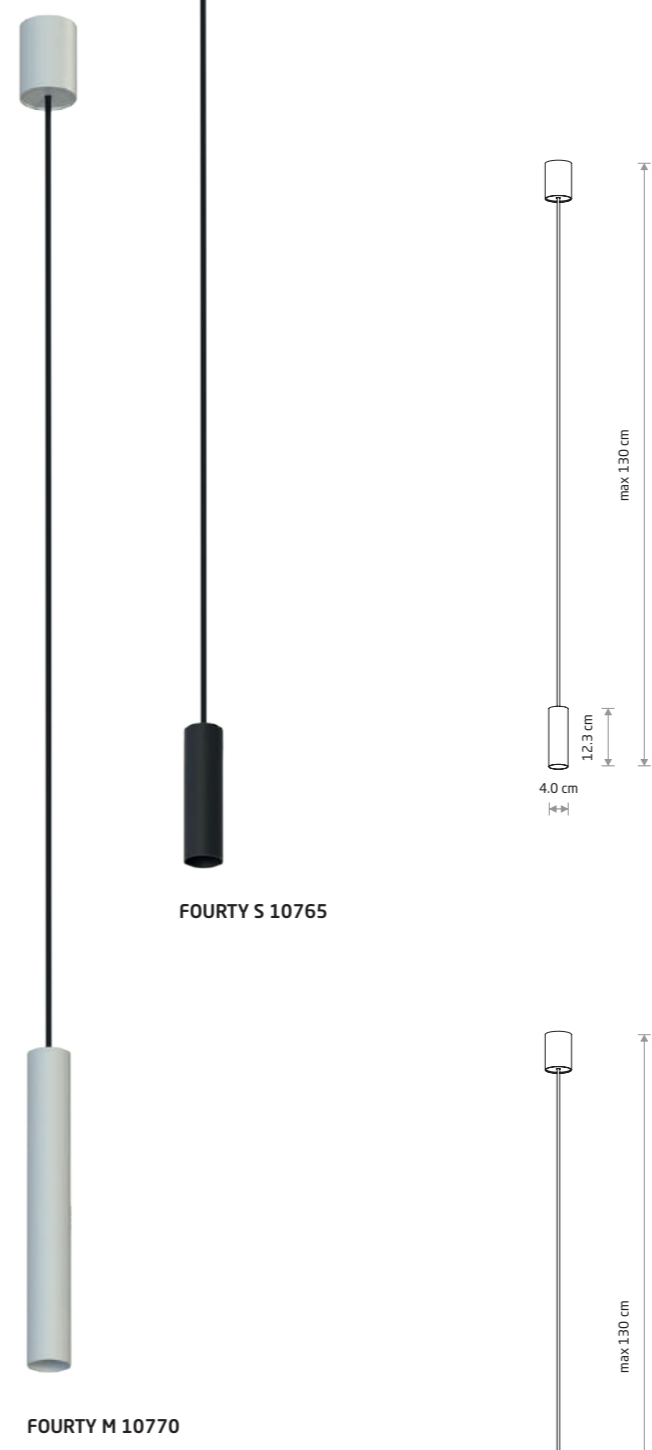

FOURTY S
 painted steel

10764 10765
 10900 10901

1xGU10 R35, max 10W only LED

solid brass, painted steel

10766

1xGU10 R35, max 10W only LED

4.0 cm
 12.3 cm
 max 130 cm

FOURTY M
 painted steel

10770 10771
 10902 10903

1xGU10 R35, max 10W only LED

solid brass, painted steel

10772

1xGU10 R35, max 10W only LED

4 cm
 30 cm
 max 130 cm



FOURTY 11766

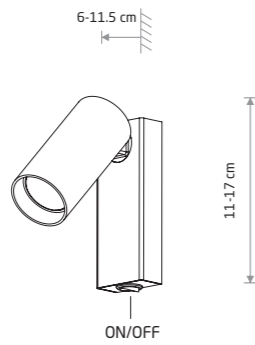

FOURTY

painting steel

■ 11763 □ 11764

■ 11765 ■ 11766

🔌 1xGU10 R35, max 10W only LED



FOURTY WALL S 10746

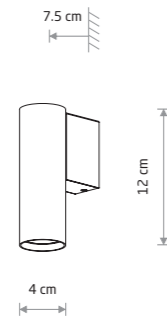

FOURTY WALL S

painting steel

□ 10746 ■ 10747

■ 10888 ■ 10889

🔌 1xGU10 R35, max 10W only LED

solid brass, painting steel

🏠 10748

🔌 1xGU10 R35, max 10W only LED



FOURTY WALL M 10891

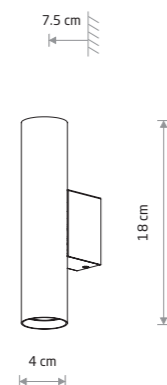

FOURTY WALL M

painting steel

□ 10752 ■ 10753

■ 10890 ■ 10891

🔌 2xGU10 R35, max 10W only LED

solid brass, painting steel

🏠 10754

🔌 2xGU10 R35, max 10W only LED

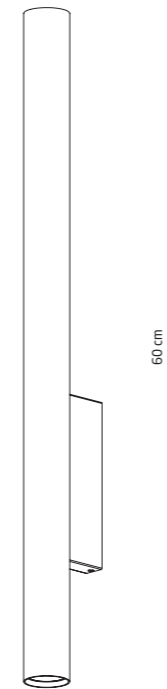

FOURTY WALL XL

painting steel

□ 10758 ■ 10759

■ 10892 ■ 10893

🔌 2xGU10 R35, max 1.0W only LED

solid brass, painting steel

🏠 10760

🔌 2xGU10 R35, max 1.0W only LED



Scan QR code to watch video manual how to change the bulb.

FOURTY WALL XL 10759

FOURTY SURFACE
11442

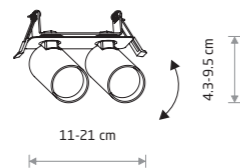

FOURTY SURFACE

■ painted steel

- 11442 □ 11443
- 11444 ■ 11473

- ⚡ 2xGU10 R35, max 10W only LED
- ✂ cut out 95 x 30 mm

FOURTY
10741

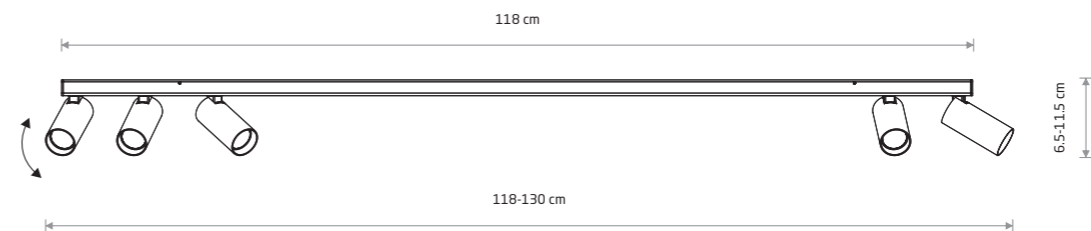

FOURTY

■ painted aluminum, painted steel

- 10741 □ 11435
- 11440 ■ 11468

- ⚡ 5xGU10 R35, max 10W only LED

FOURTY
10737

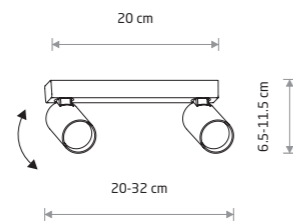

FOURTY

■ painted aluminum, painted steel

- 10737 □ 11433
- 11437 ■ 11466

- ⚡ 2xGU10 R35, max 10W only LED

FOURTY
10739

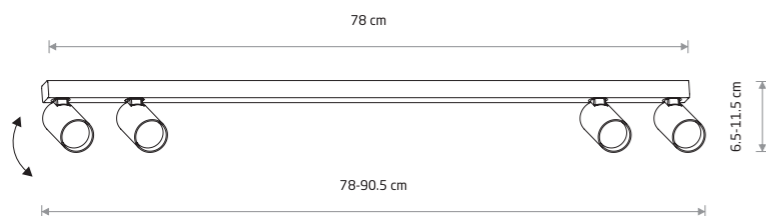

FOURTY

■ painted aluminum, painted steel

- 10739 □ 11434
- 11438 ■ 11467

- ⚡ 4xGU10 R35, max 10W only LED

FOURTY
10743

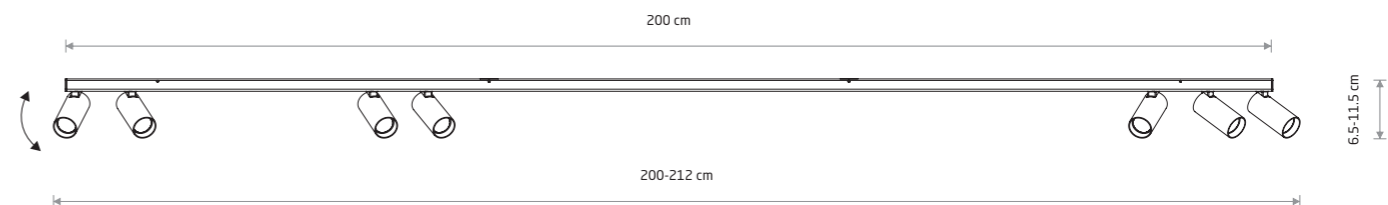

FOURTY

■ painted aluminum, painted steel

- 10743 □ 11436
- 11441 ■ 11470

- ⚡ 7xGU10 R35, max 10W only LED



MONO 7708

Visualisation by Iwona Ligeza

3 warianty kolekcji MONO /
3 variants of the MONO collection

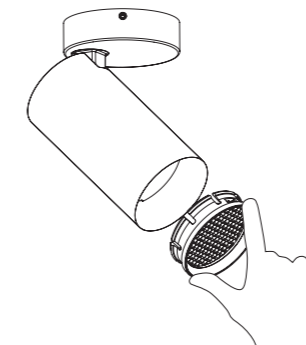
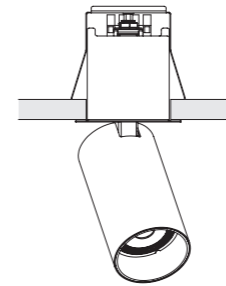
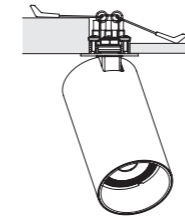
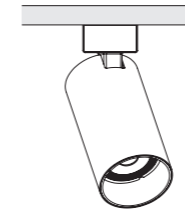

MONO



MONO SURFACE



MONO DEEP



Filtr przeciwośnieniowy "plaster miodu".
Do zastosowania z kolekcją lamp MONO.

Anti-glare "honeycomb".
For use with the MONO lamp collection.

Scan QR code to watch video manual
on changing the bulb.





Visualisation by Iwona Ligęza



HONEY COMB 11427



MONO S 10777
HONEY COMB 11427



MONO S 10784
HONEY COMB 11427



MONO S 10779
HONEY COMB 11427

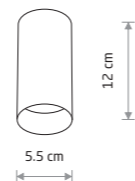

MONO S

painted steel

- 10776 10777 10778
- 10779 10781 10782
- 10783 10784 10785
- 10786

1xGU10 R50, max 10W only LED

solid brass

- 10780

1xGU10 R50, max 10W only LED

MONO 7807

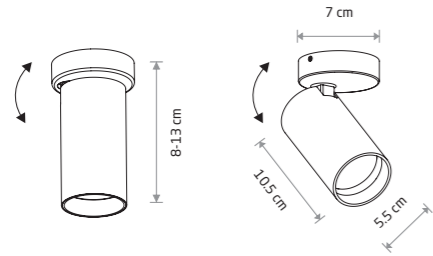

MONO

■ painted steel, plastic ABS

□ 7807 ■ 7838

■ 7771 ■ 7763

● 1xGU10 R50, max 10W only LED

■ solid brass, painted steel, plastic ABS

■ 7778

● 1xGU10 R50, max 10W only LED

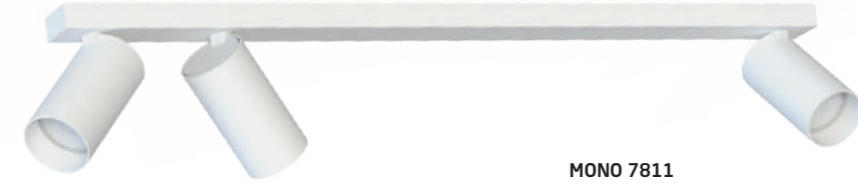

MONO 7811

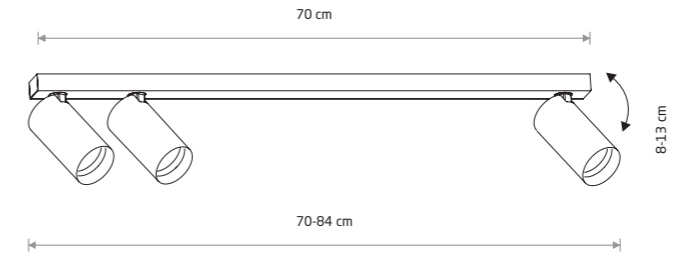

MONO

■ painted steel, plastic ABS

□ 7811 ■ 7842

■ 7775 ■ 7767

● 3xGU10 R50, max 10W only LED

■ solid brass, painted steel, plastic ABS

■ 7783

● 3xGU10 R50, max 10W only LED



MONO 7810

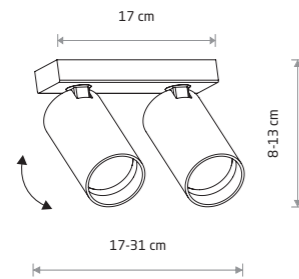

MONO

■ painted steel, plastic ABS

□ 7810 ■ 7841

■ 7774 ■ 7766

● 2xGU10 R50, max 10W only LED

■ solid brass, painted steel, plastic ABS

■ 7782

● 2xGU10 R50, max 10W only LED



MONO 7812

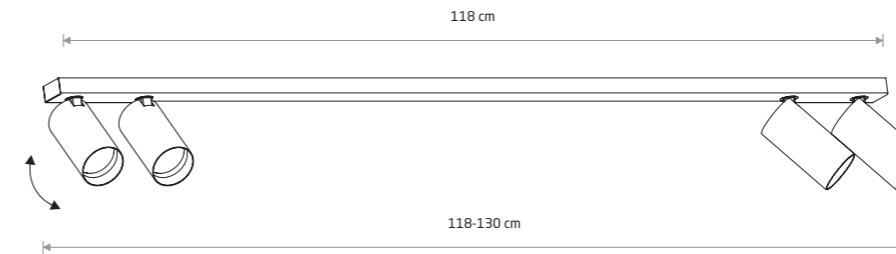

MONO

■ painted steel, plastic ABS

□ 7812 ■ 7843

■ 7776 ■ 7768

● 4xGU10 R50, max 10W only LED

■ solid brass, painted steel, plastic ABS

■ 7784

● 4xGU10 R50, max 10W only LED

MONO CORNER 2X150
7721

MONO 7708

MONO

painting steel, plastic ABS

7813 7844

7777 7770

6xGU10 R50, max 10W only LED

solid brass, painting steel, plastic ABS

7785

6xGU10 R50, max 10W only LED

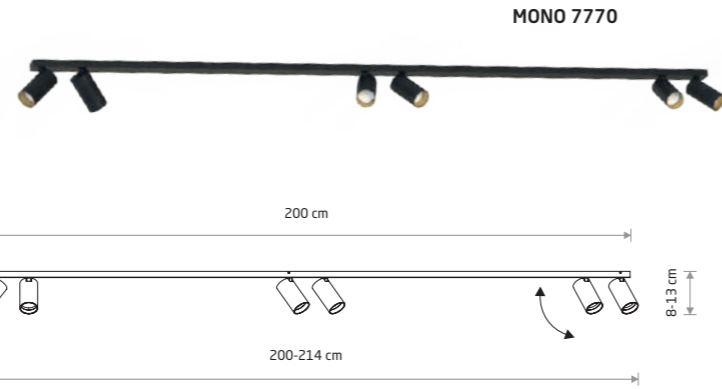

MONO 2X150

painting steel, plastic ABS

7750 7720

7694 7698

8xGU10 R50, max 10W only LED

solid brass, painting steel, plastic ABS

7754

8xGU10 R50, max 10W only LED

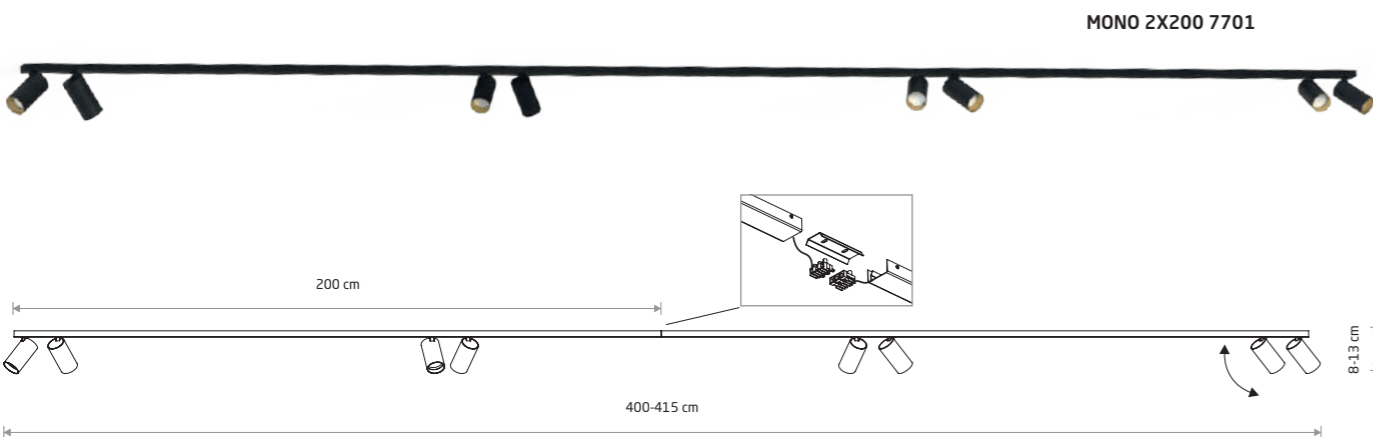
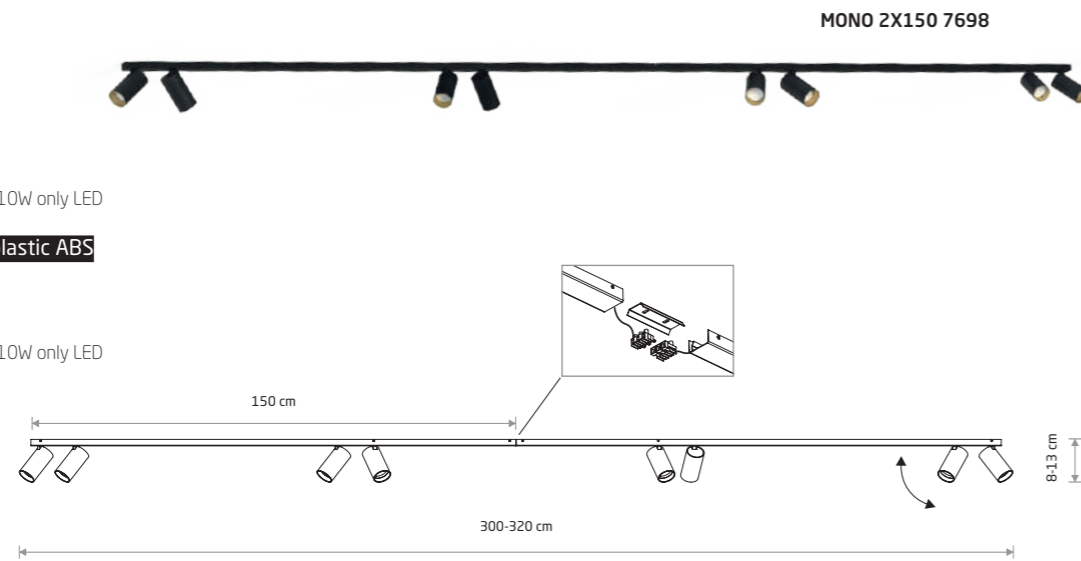

MONO 2X200

painting steel, plastic ABS

7752 7722

7696 7701

8xGU10 R50, max 10W only LED

WHITE P004 RAL 9003 BLACK P013 RAL 9005 BRASS GOLD P021



MONO CORNER 2X150 7700

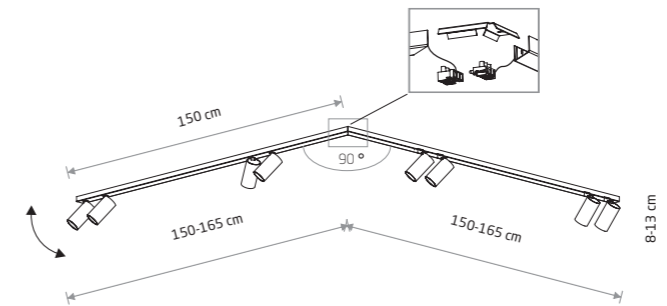

MONO CORNER 2X150

painting steel, plastic ABS

7751 7721

7695 7700

8xGU10 R50, max 10W only LED

solid brass, painting steel, plastic ABS

7755

8xGU10 R50, max 10W only LED



MONO CORNER 2X200 7702

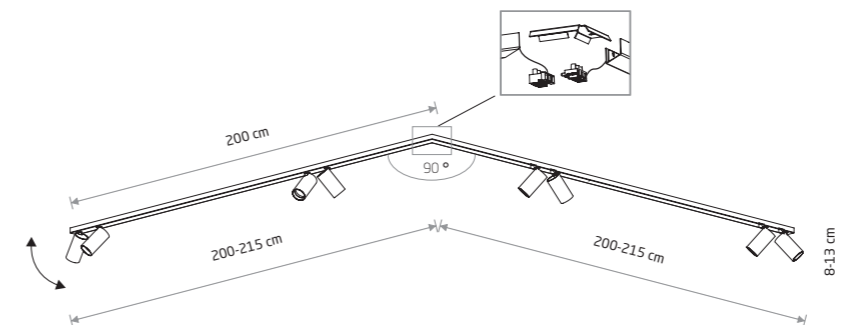

MONO CORNER 2X200

painting steel, plastic ABS

7753 7723

7697 7702

8xGU10 R50, max 10W only LED

WHITE P004 RAL 9003 BLACK P013 RAL 9005 BRASS GOLD P021



MONO LONG 7728

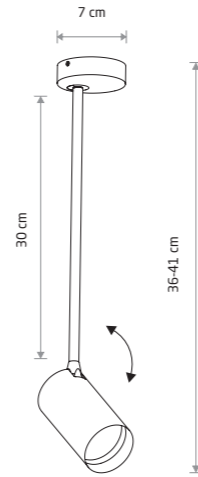

MONO LONG M

painting steel, plastic ABS

7725 7728

7671 7674

1xGU10 R50, max 10W only LED

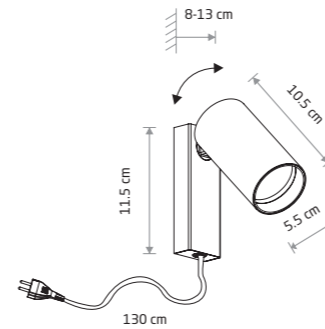
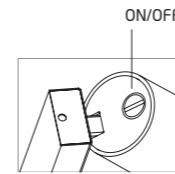

MONO 7786

MONO

painting steel, plastic ABS

7787 7786

1xGU10 R50, max 10W only LED



MONO LONG 7730

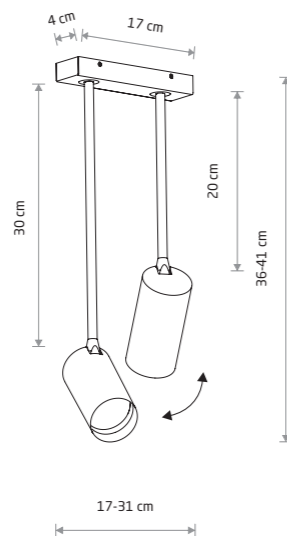

MONO LONG

painting steel, plastic ABS

7726 7730

7672 7675

2xGU10 R50, max 10W only LED

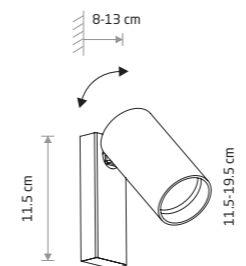
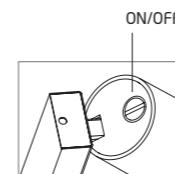

MONO 7840

MONO

painting steel, plastic ABS

7808 7840

7772 7764

1xGU10 R50, max 10W only LED

solid brass, painting steel, plastic ABS

7780

1xGU10 R50, max 10W only LED

MONO SURFACE 7833



MONO SURFACE

painting steel, plastic ABS

7827 7833

7683 7688

1xGU10 R50, max 10W only LED

cut out ø 35 mm

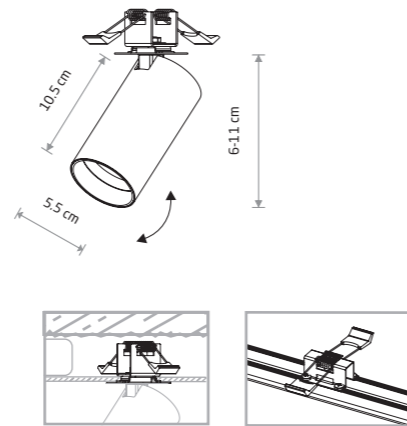

MONO SURFACE 7834



MONO SURFACE

painting steel, painted aluminum, plastic ABS

7828 7834

2xGU10 R50, max 10W only LED

cut out 160x31 mm

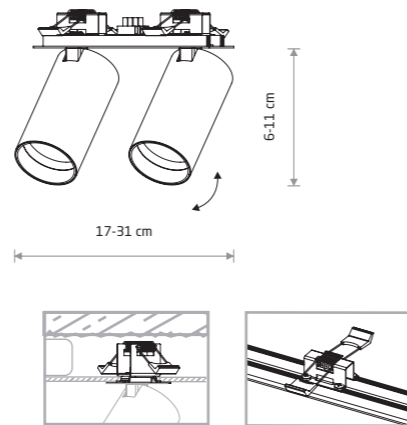

MONO SURFACE 7635

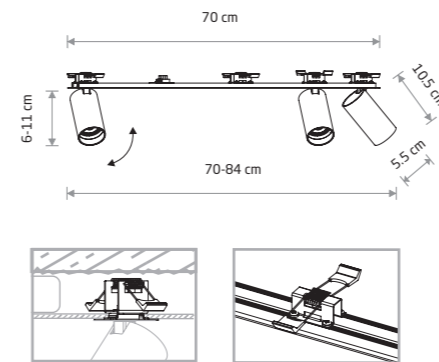

MONO SURFACE 7836

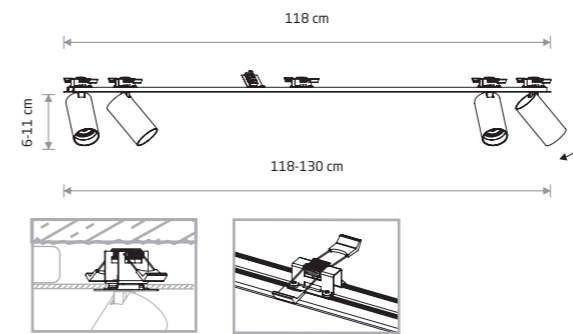

MONO SURFACE

painting steel, painted aluminum, plastic ABS

7830 7835

3xGU10 R50, max 10W only LED

cut out 690x31 mm

MONO SURFACE

painting steel, painted aluminum, plastic ABS

7831 7836

4xGU10 R50, max 10W only LED

cut out 1170x31 mm

MONO SURFACE 7837

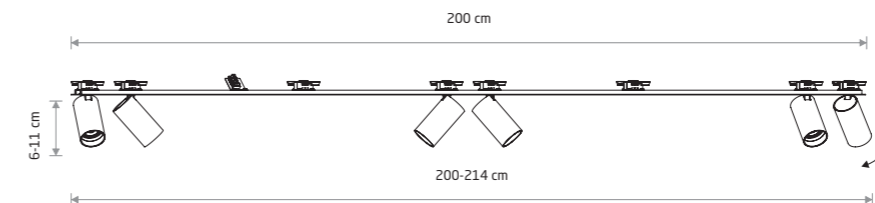

MONO SURFACE

painting steel, painted aluminum, plastic ABS

7832 7837

6xGU10 R50, max 10W only LED

cut out 1990x31 mm



MONO DEEP 10460

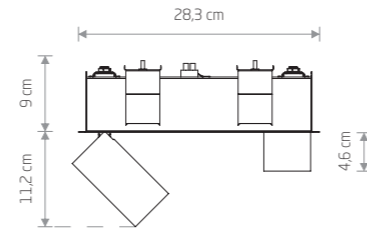
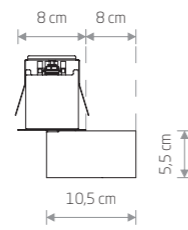

MONO DEEP

painting steel, plastic PC

10465 10460

2xGU10 R50, max 10W only LED

cut out 64x268 mm

MONO DEEP 10463

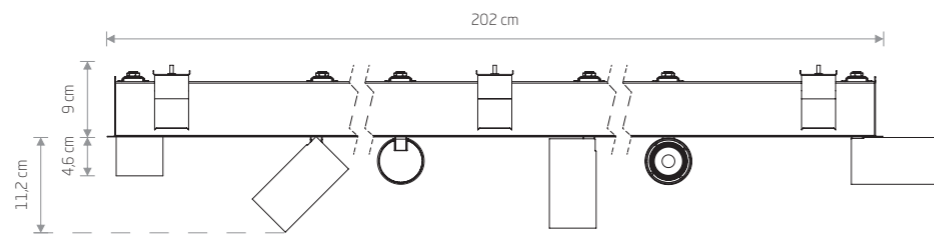
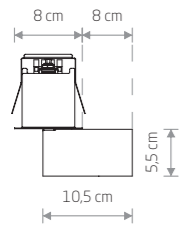

MONO DEEP

painting steel, plastic PC

10468 10463

6xGU10 R50, max 10W only LED

cut out 64x2002 mm



MONO SLIDE 10796



MONO SLIDE TRIMLESS 10803

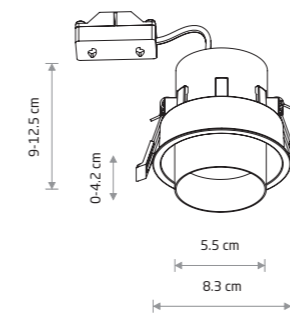

MONO SLIDE

painting steel, plastic PA

10795 10796 10797

10798 10799 10800

10801

1xGU10 R50, max 10W only LED

cut out ø 76 mm

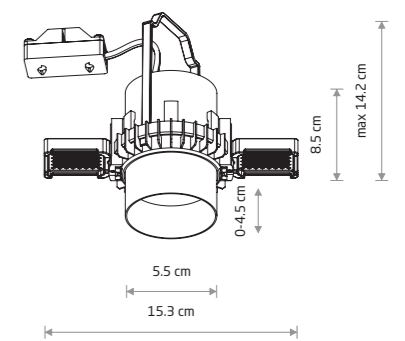

MONO SLIDE TRIMLESS

painting steel, plastic PA, plastic ABS

10802 10803 10804

10805 10806 10807

1xGU10 R50, max 10W only LED

cut out ø 76 mm

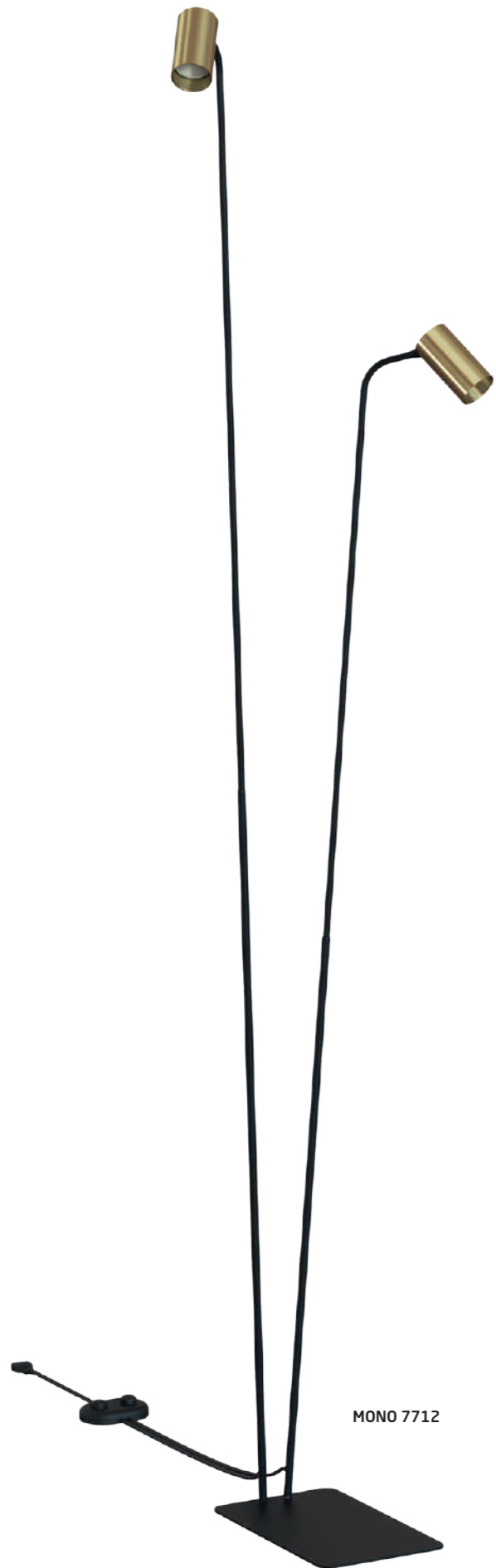

MONO 7712



MONO

painting steel, plastic ABS

7705 7708

7715 7718

2xGU10 R50, max 10W only LED

solid brass, painting steel, plastic ABS

7712

2xGU10 R50, max 10W only LED

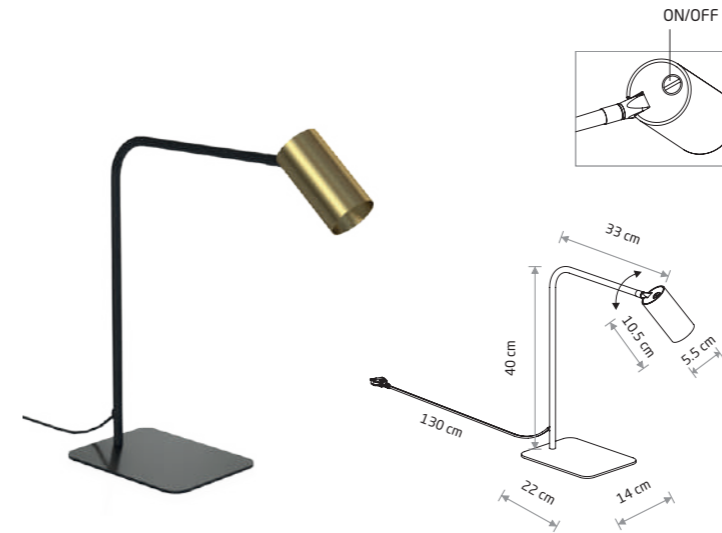

MONO 7710

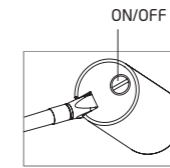
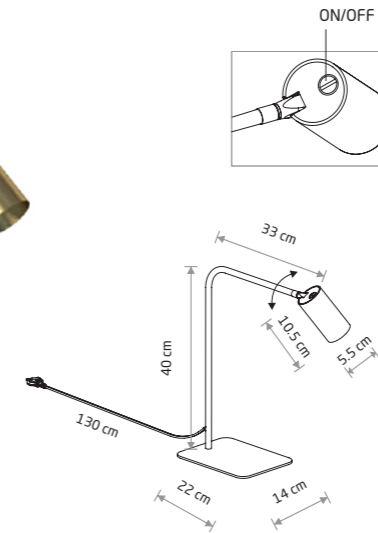

MONO 7711

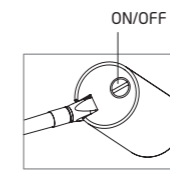
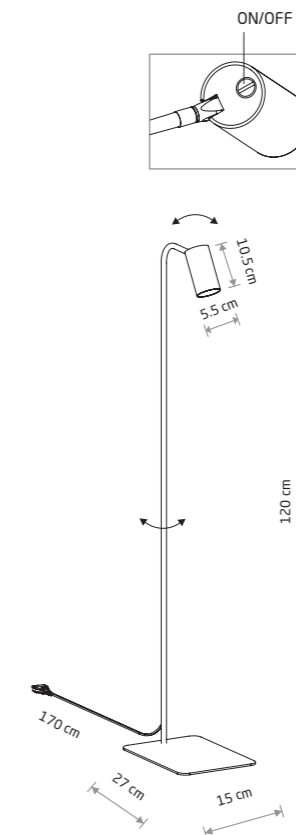

MONO

painting steel, plastic ABS

7703 7706

7713 7716

1xGU10 R50, max 10W only LED

solid brass, painting steel, plastic ABS

7710

1xGU10 R50, max 10W only LED

MONO

painting steel, plastic ABS

7704 7707

7714 7717

1xGU10 R50, max 10W only LED

solid brass, painting steel, plastic ABS

7711

1xGU10 R50, max 10W only LED



EYE M 5397

EYE L 6841

EYE L 8800

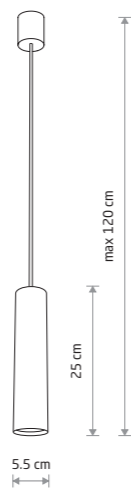

EYE M

painted steel

5397 6840

1xGU10 R50, max 10W only LED

solid brass, painted steel

8914

1xGU10 R50, max 10W only LED

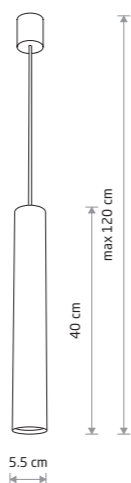

EYE L

painted steel

5455 6841

1xGU10 R50, max 10W only LED

solid brass, painted steel

8800

1xGU10 R50, max 10W only LED



EYE 7863

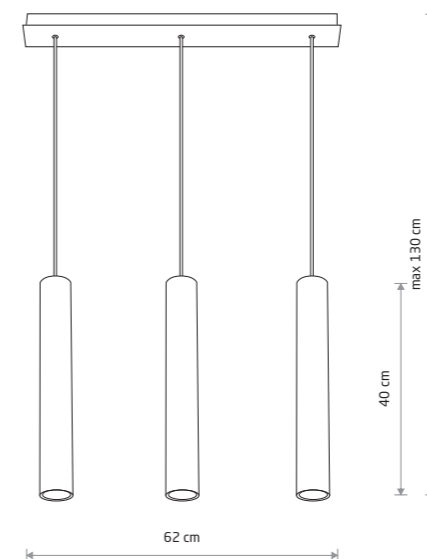

EYE

painted steel

6481 7862

3xGU10 R50, max 10W only LED

solid brass, painted steel

7863

3xGU10 R50, max 10W only LED



EYE L 8916

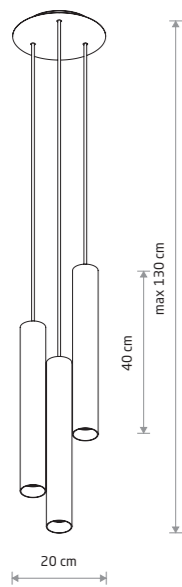

EYE L

painting steel

8916 8917

3xGU10 R50, max 10W only LED

solid brass, painting steel

8915

3xGU10 R50, max 10W only LED

EYE L 8915



BATON 7852



BATON 7851

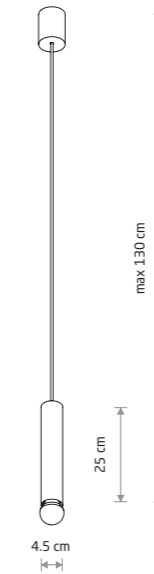
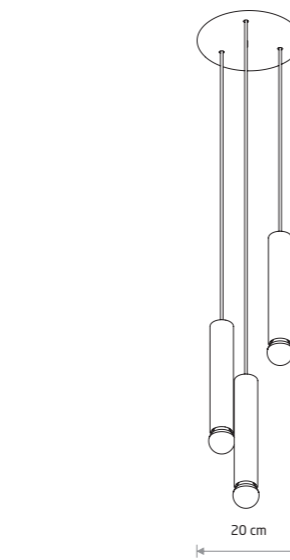

BATON

painting steel

7852

1xE27, max 10W only LED

solid brass, painting steel

7851

1xE27, max 10W only LED

BATON 7856



BATON

painting steel

7856

3xE27, max 10W only LED

solid brass, painting steel

7855

3xE27, max 10W only LED

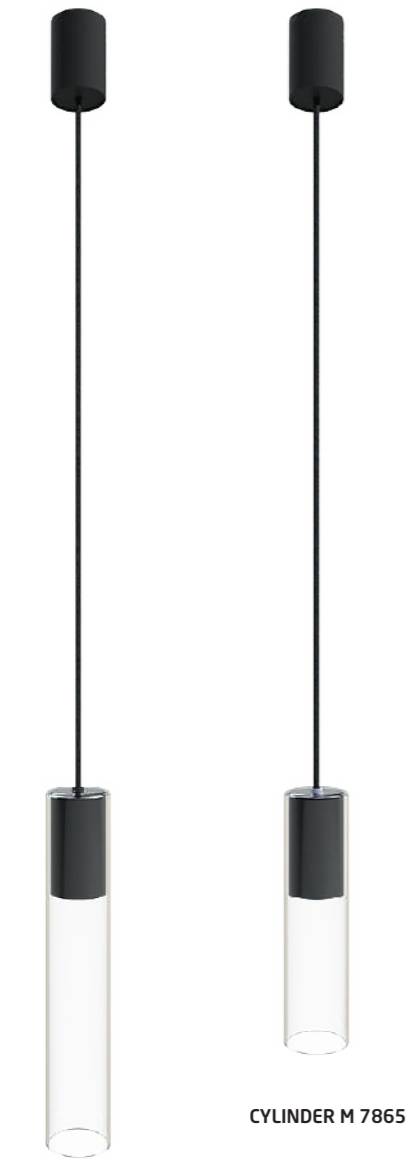

CYLINDER L 7864

CYLINDER M 7865



CYLINDER M

glass, painted steel

7865

1xGU10 R50, max 10W only LED

glass, solid brass, painted steel

7868

1xGU10 R50, max 10W only LED

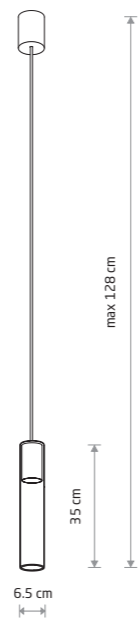

CYLINDER L

glass, painted steel

7864

1xGU10 R50, max 10W only LED

glass, solid brass, painted steel

7867

1xGU10 R50, max 10W only LED

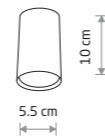

EYE S

painted steel

5255 6836

1xGU10 R50, max 10W only LED

solid brass

8911

1xGU10 R50, max 10W only LED

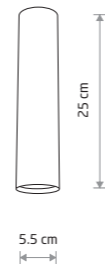

EYE M

painted steel

5463 6837

1xGU10 R50, max 10W only LED

solid brass

8912

1xGU10 R50, max 10W only LED



EYE L

painted steel

5471 6838

1xGU10 R50, max 10W only LED

solid brass

8913

1xGU10 R50, max 10W only LED



EYE M 5463



EYE L 6838



EYE 6842

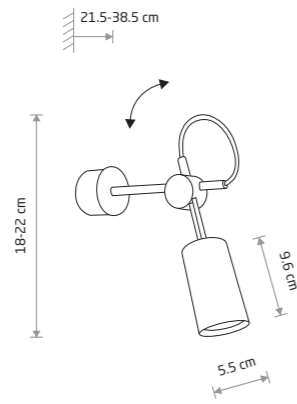

EYE

painting steel

5654 6842

1xGU10 R50, max 10W only LED

EYE FLEX S

painting steel, flexible stem

9070 9068

1xGU10 R50, max 10W only LED

solid brass, flexible stem, painting steel

9067

1xGU10 R50, max 10W only LED

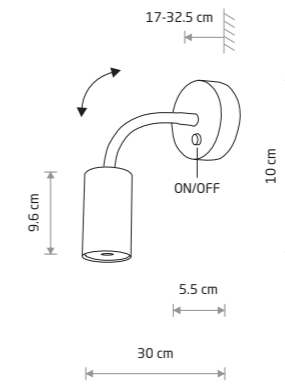

EYE FLEX S 9067



EYE WALL 8072

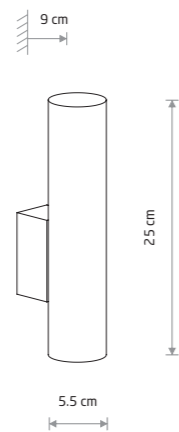

EYE WALL

painting steel

8073 8072

2xGU10 R50, max 10W only LED

solid brass, painting steel

8074

2xGU10 R50, max 10W only LED

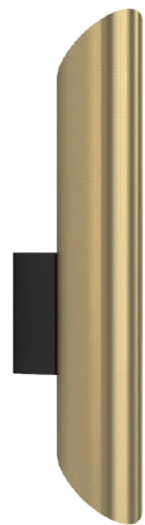

EYE WALL CUT 7995

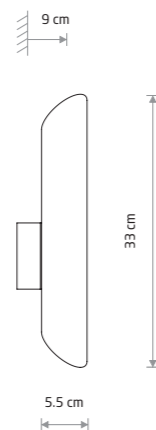

EYE WALL CUT

painting steel

7993 7994

2xGU10 R50, max 10W only LED

solid brass, painting steel

7995

2xGU10 R50, max 10W only LED

EYE FLEX 8935

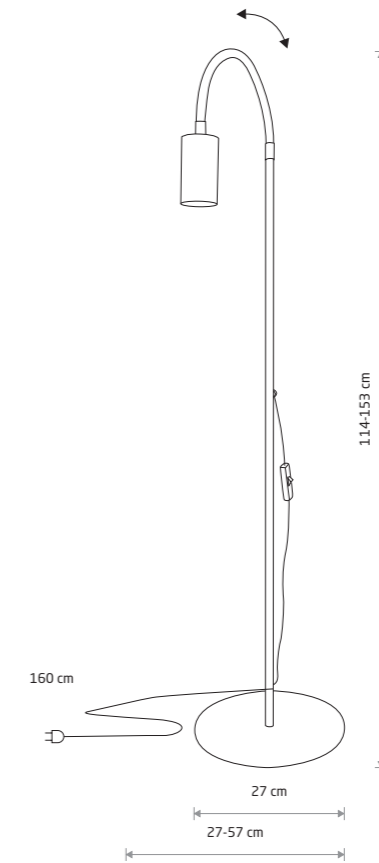

EYE FLEX

painting steel, flexible stem

8934 8935

1xGU10 R50, max 10W only LED



EYE SPOT 6018

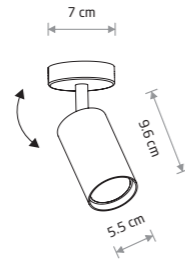

EYE SPOT

■ painted steel, chrome

□ 6014 ■ 6018

● 1xGU10 R50, max 10W only LED

■ solid brass, painted steel

■ 8816

● 1xGU10 R50, max 10W only LED

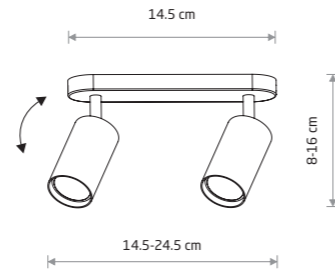

EYE SPOT 6611

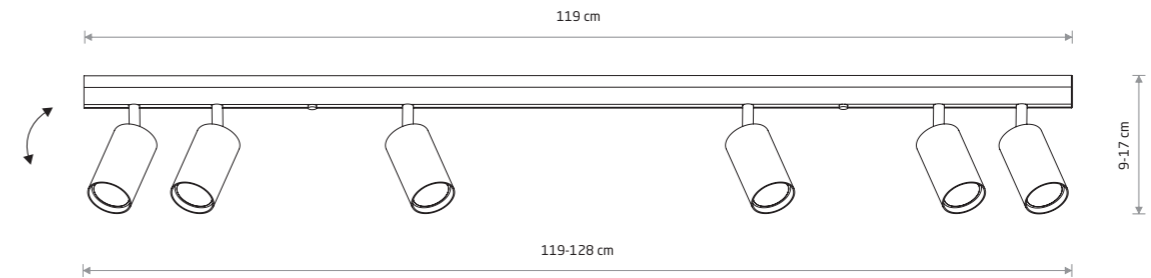

EYE SPOT

■ painted steel, chrome

□ 6607 ■ 6611

● 6xGU10 R50, max 10W only LED

■ solid brass, painted steel

■ 8819

● 6xGU10 R50, max 10W only LED



EYE SPOT 6020

EYE SPOT

■ painted steel, chrome

□ 6015 ■ 6020

● 2xGU10 R50, max 10W only LED

■ solid brass, painted steel

■ 8817

● 2xGU10 R50, max 10W only LED

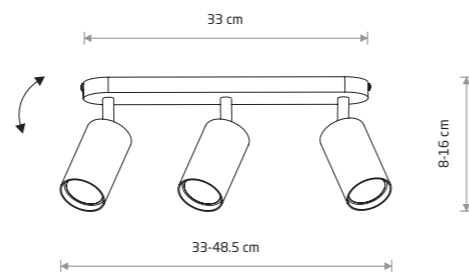

EYE SPOT 6021

EYE SPOT

■ painted steel, chrome

□ 6016 ■ 6021

● 3xGU10 R50, max 10W only LED

■ solid brass, painted steel

■ 8818

● 3xGU10 R50, max 10W only LED

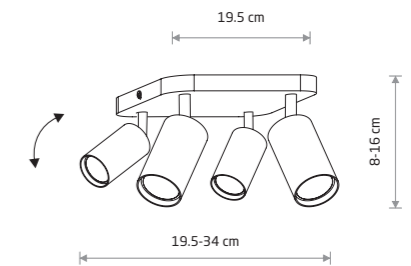

EYE SPOT 6022

EYE SPOT

■ painted steel, chrome

□ 6017 ■ 6022

● 4xGU10 R50, max 10W only LED

■ solid brass, painted steel

■ 8820

● 4xGU10 R50, max 10W only LED

EYE SUPER 6506

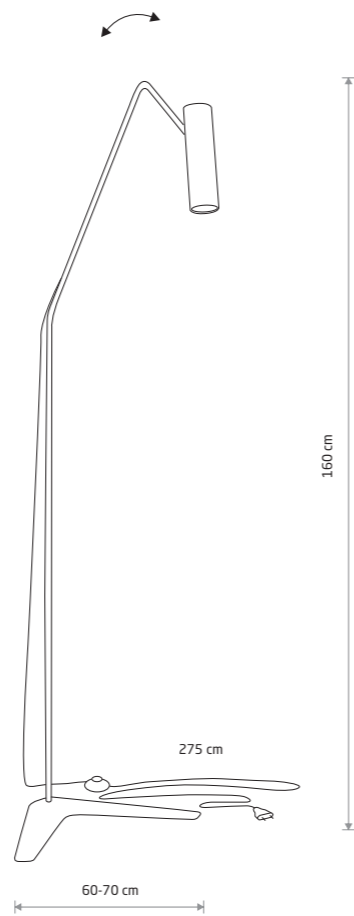
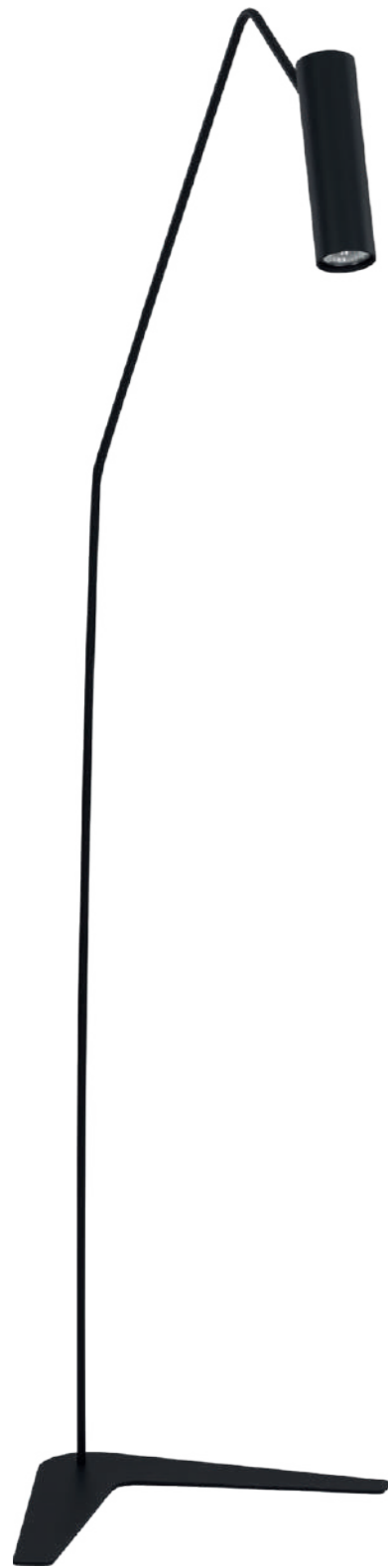

EYE SUPER
painted steel

6493 6506

1xGU10 R50, max 10W only LED

EYE SUPER B 6490

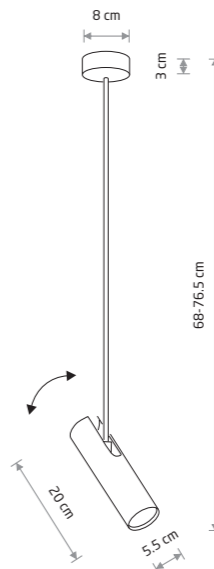
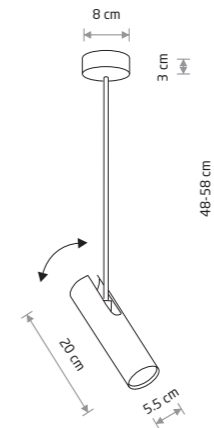

EYE SUPER A

painted steel

6488 6502

1xGU10 R50, max 10W only LED

EYE SUPER B

painted steel

6490 6503

1xGU10 R50, max 10W only LED

EYE SUPER 6501

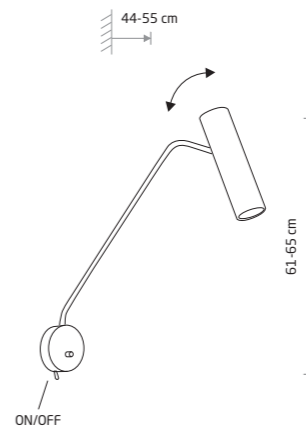

EYE SUPER

painted steel, chrome

6487 6501

1xGU10 R50, max 10W only LED

EYE SUPER 6491

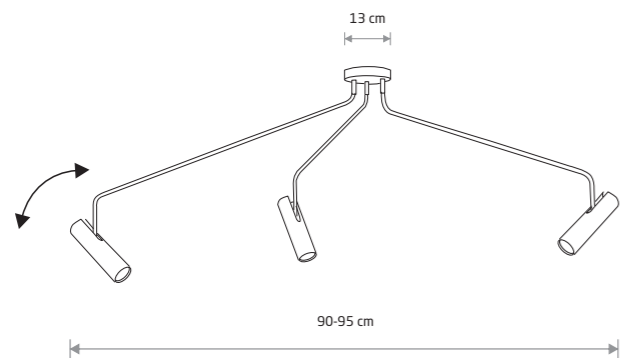
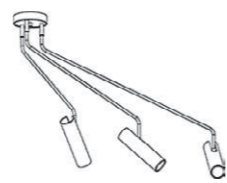
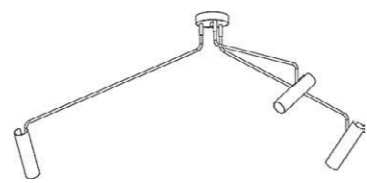

EYE SUPER
painted steel, chrome

■ 6491 ■ 6504

● ● 3xGU10 R50, max 10W only LED

EYE SUPER 6505

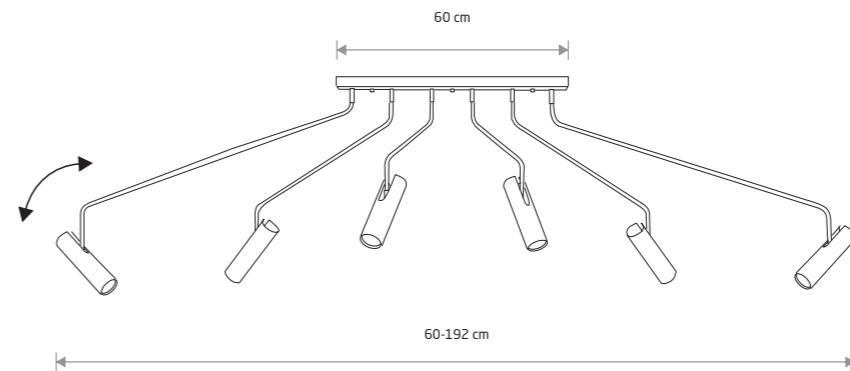
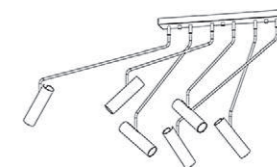
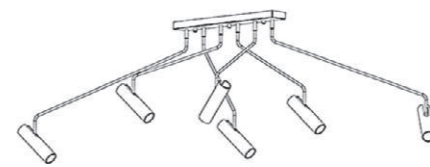

EYE SUPER
painted steel, chrome

■ 6492 ■ 6505

● ● 6xGU10 R50, max 10W only LED

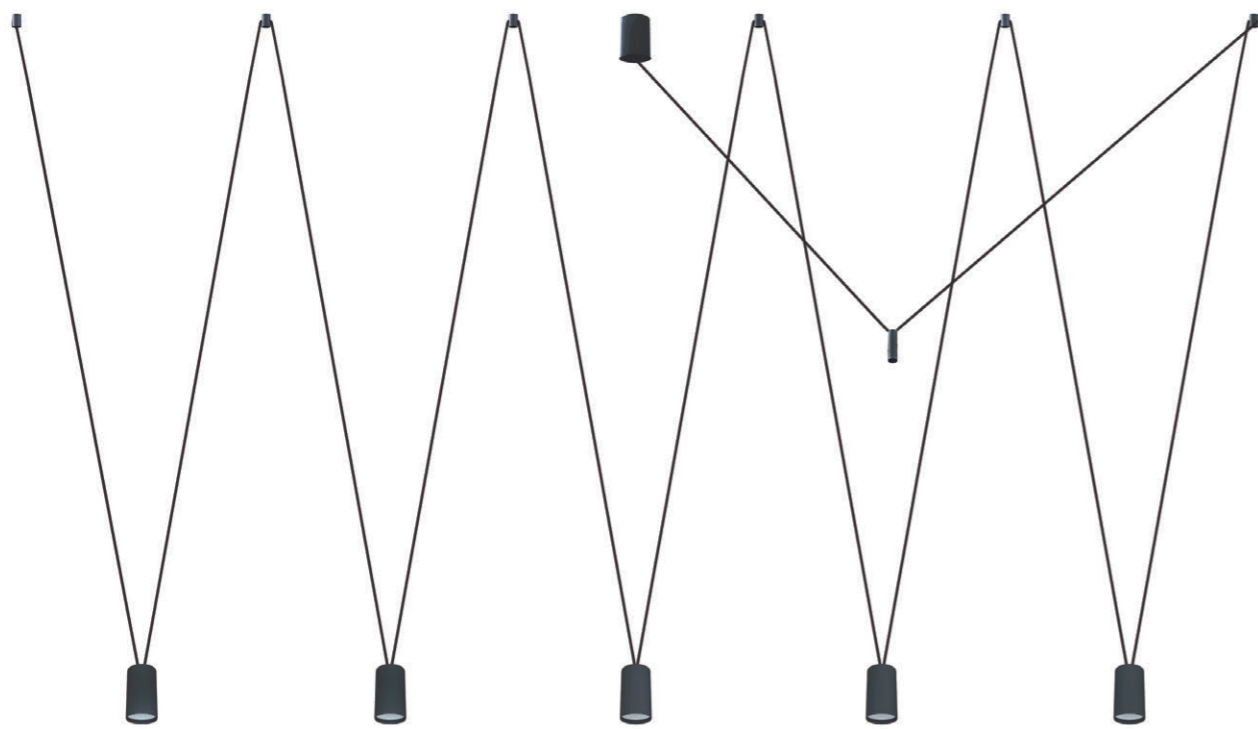

MORE EYE 7825



MORE TONE 7817

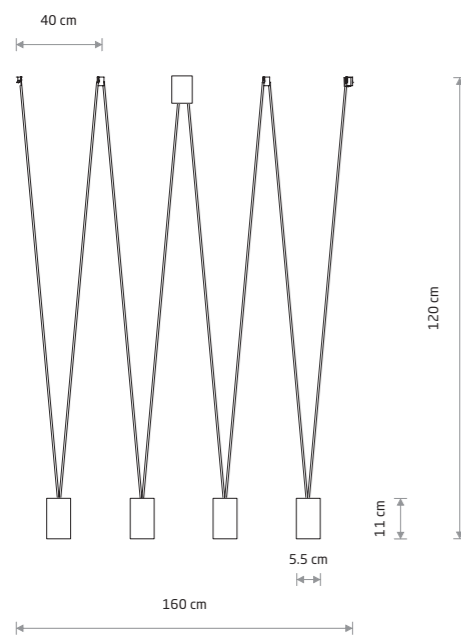

MORE EYE

■ painted steel

■ 7822

● 4xGU10 R50, max 10W only LED

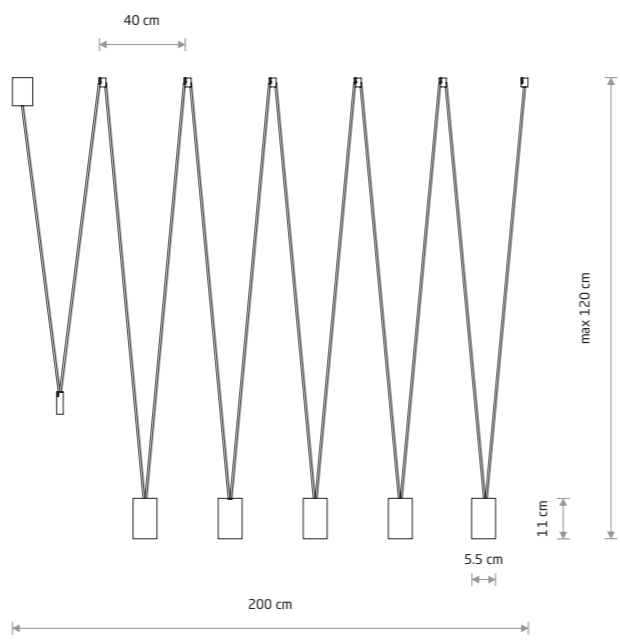

MORE EYE

■ painted steel

■ 7825

● 5xGU10 R50, max 10W only LED

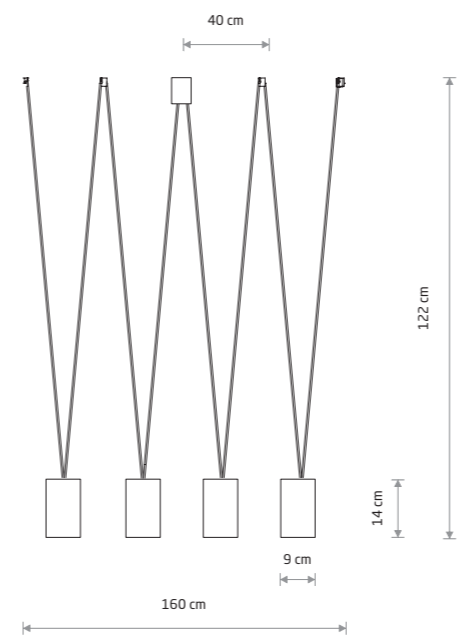

MORE TONE

■ painted steel, plastic ABS

■ 7814

● 4xGU10 R50, max 10W only LED

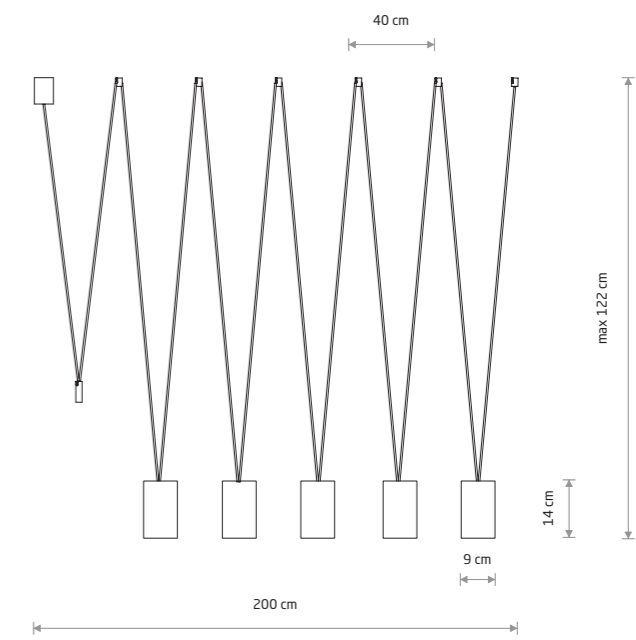

MORE TONE

■ painted steel, plastic ABS

■ 7817

● 5xGU10 R50, max 10W only LED

IMBRAIA 9675

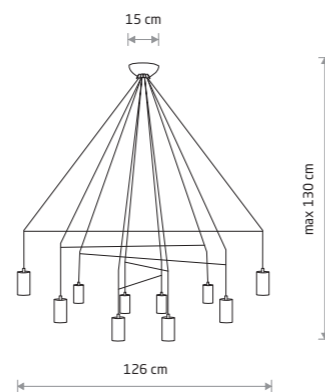
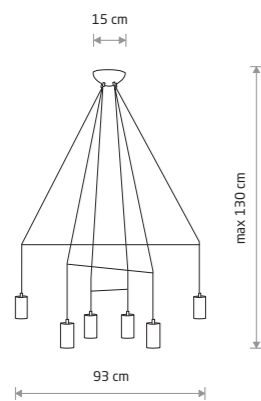
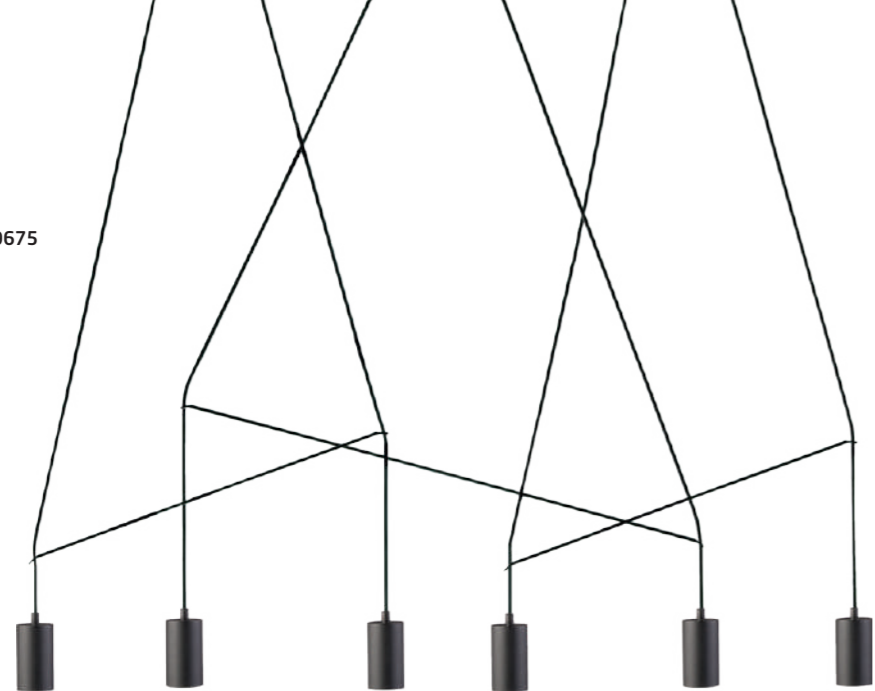

IMBRIA
painted steel, braided cable

■ 9677

● 6xGU10, max 10W only LED

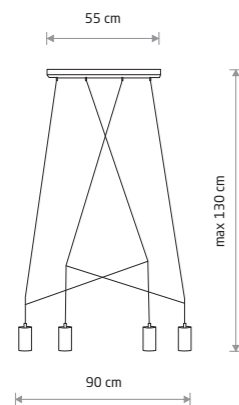

IMBRIA
painted steel, braided cable

■ 9680

● 10xGU10 R50, max 10W only LED

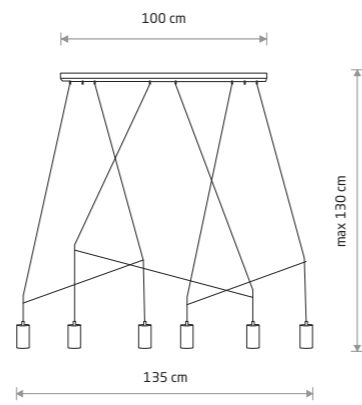

IMBRIA
painted steel, braided cable

■ 9192

● 4xGU10, max 10W only LED

IMBRIA
painted steel, braided cable

■ 9675

● 6xGU10 R50, max 10W only LED

SLING 10355

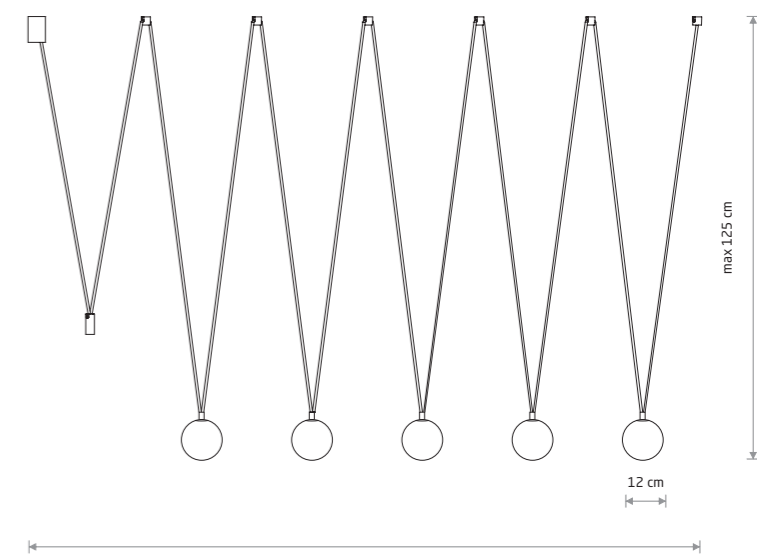
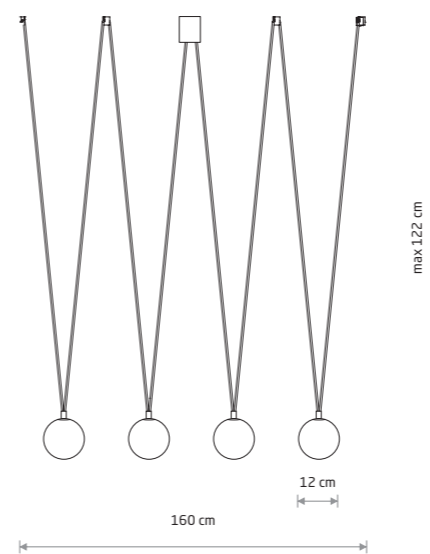
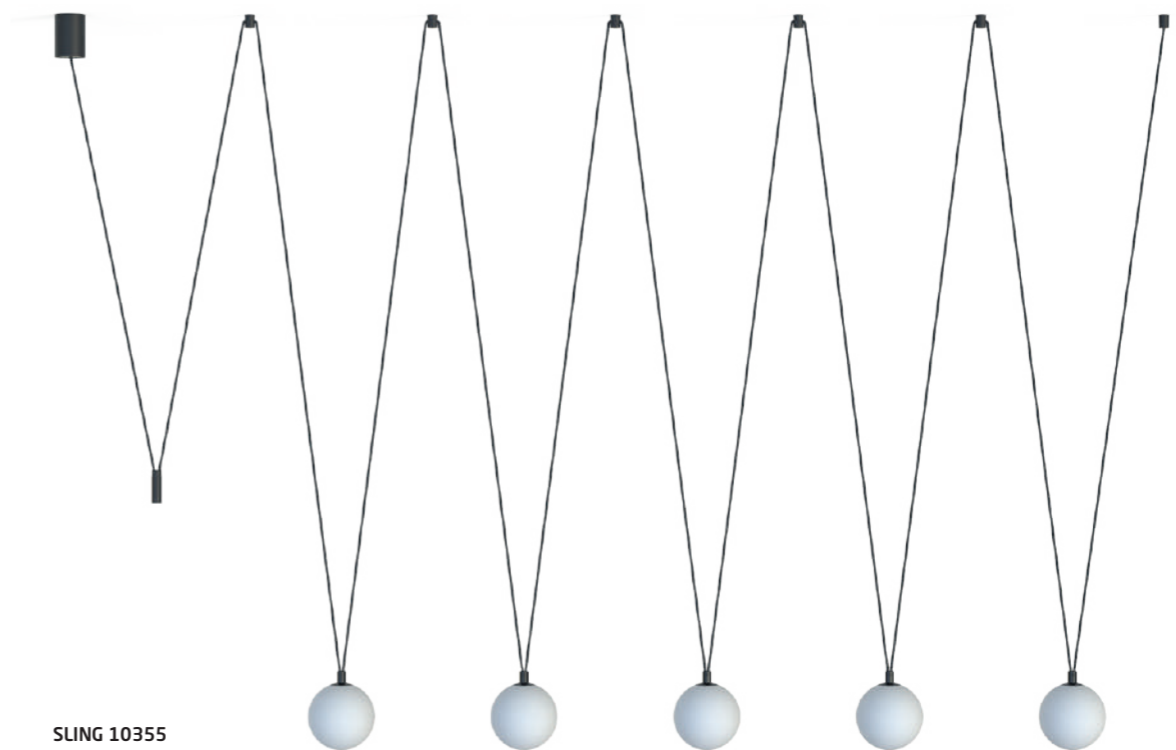

SLING
glass, painted steel

■ 10354

● 4xG9, max 12W only LED

SLING
glass, painted steel

■ 10355

● 5xG9, max 12W only LED



KARO 10304

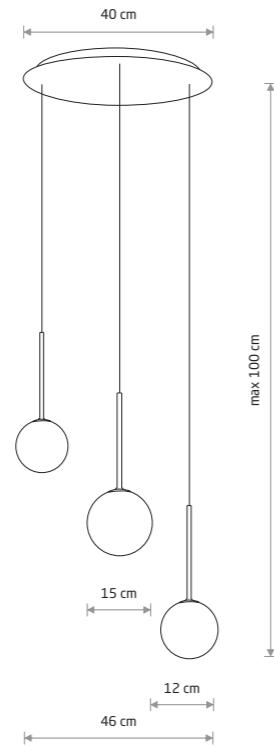

KARO

■ painted steel, glass

■ 10304

● 3xG9, max 12W only LED

■ BULB LED G9, 4W

□ 7503 3000K □ 7504 4000K

KARO 10934

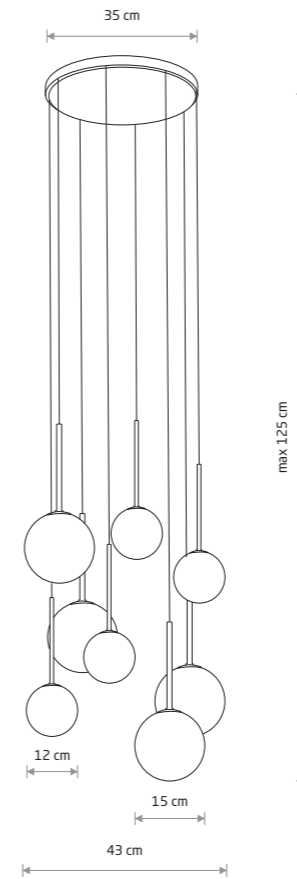

KARO

■ painted steel, glass

■ 10934

● 8xG9, max 12W only LED

■ BULB LED G9, 4W

□ 7503 3000K □ 7504 4000K

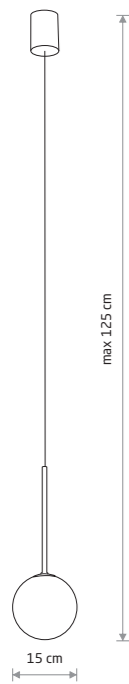

KARO

■ painted steel, glass

■ 10305

● 1xG9, max 12W only LED

■ BULB LED G9, 4W

□ 7503 3000K □ 7504 4000K

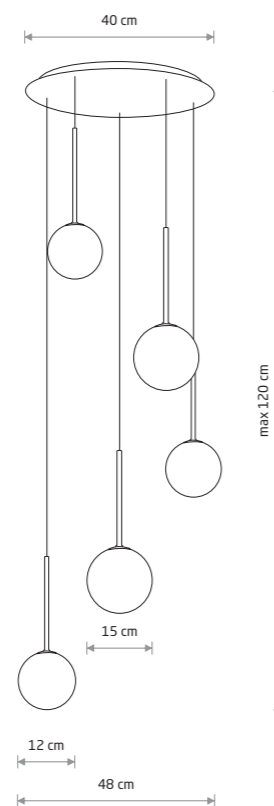

KARO

■ painted steel, glass

■ 10303

● 5xG9, max 12W only LED

■ BULB LED G9, 4W

□ 7503 3000K □ 7504 4000K



SNOWBALL 11408

The Mosaic Book of JAPAN
NEW YORK

SNOWBALL
11408

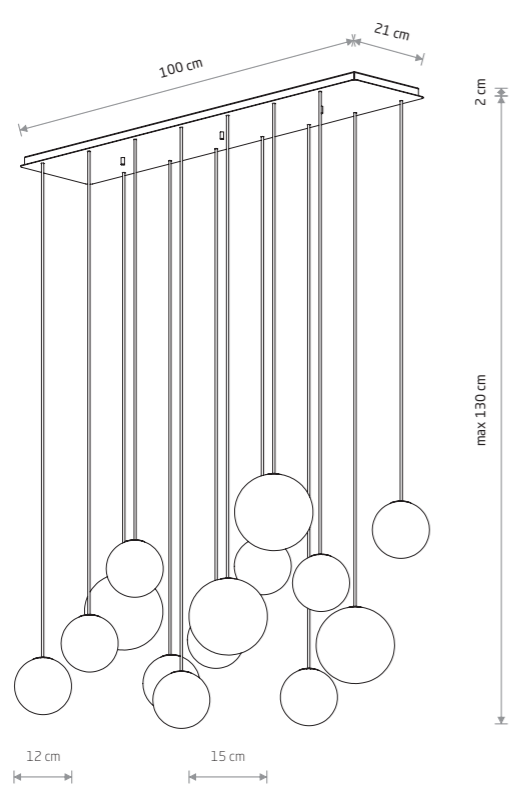
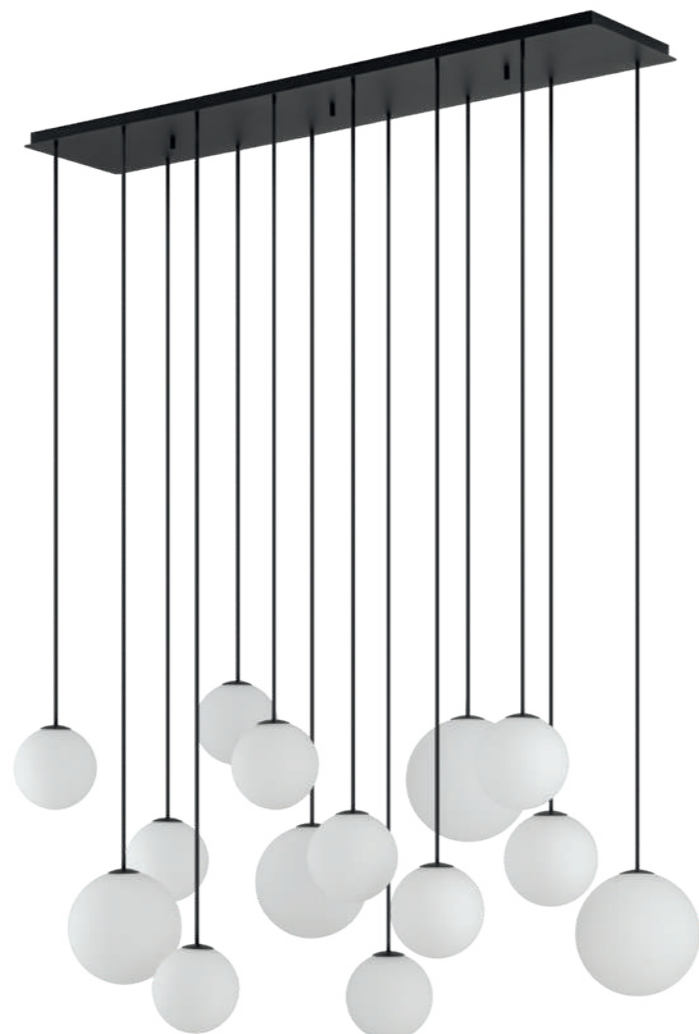

SNOWBALL
painted steel, glass

- 11408
- ⚡ 14xG9, max 12W only LED
- 💡 BULB LED G9, 4W
- 7503 3000K □ 7504 4000K

KIER M 10307

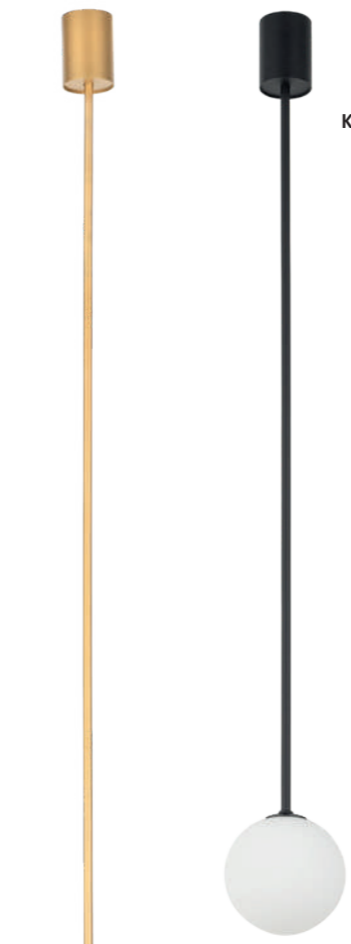

KIER L 10308

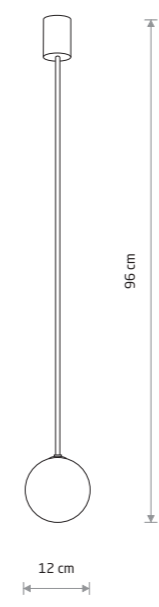

KIER M
painted steel, glass

- 10307 ■ 10306
- ⚡ 1xG9, max 12W only LED
- 💡 BULB LED G9, 4W
- 7503 3000K □ 7504 4000K

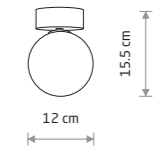

KIER S

- painted steel, glass
- 10302 ■ 10623
 - ⚡ 1xG9, max 12W only LED
 - 💡 BULB LED G9, 4W
 - 7503 3000K □ 7504 4000K

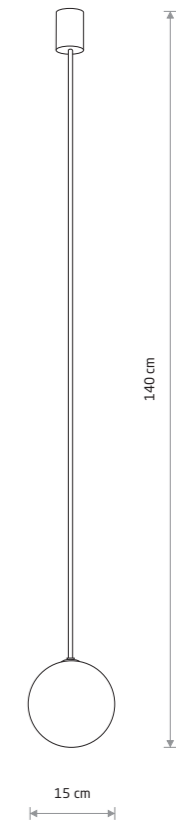

KIER L
painted steel, glass

- 10310 ■ 10308
- ⚡ 1xG9, max 12W only LED
- 💡 BULB LED G9, 4W
- 7503 3000K □ 7504 4000K



PIK 10301

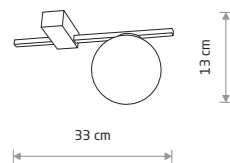

PIK
painted aluminum, glass

10299

1xG9, max 12W only LED

BULB LED G9, 4W

7503 3000K 7504 4000K

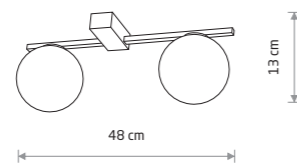

PIK
painted aluminum, glass

10300

2xG9, max 12W only LED

BULB LED G9, 4W

7503 3000K 7504 4000K

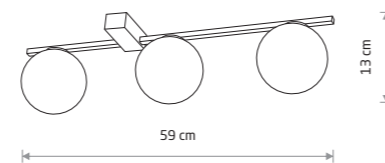

PIK
painted aluminum, glass

10301

3xG9, max 12W only LED

BULB LED G9, 4W

7503 3000K 7504 4000K

BLACK P013 RAL 9005 WHITE



GLOBE PLUS M 7606

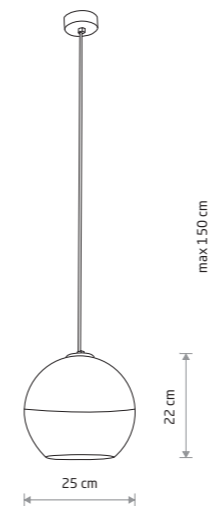

GLOBE PLUS M
metallized glass, painted steel

7606

1xE27, max 25W only LED



GLOBE PLUS S 7605

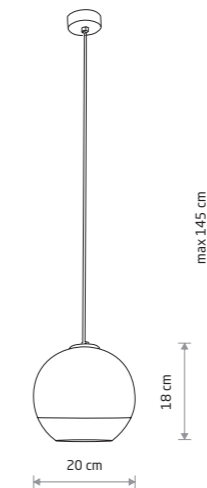

GLOBE PLUS S
metallized glass, painted steel

7605

1xE27, max 25W only LED



GLOBE PLUS 7607

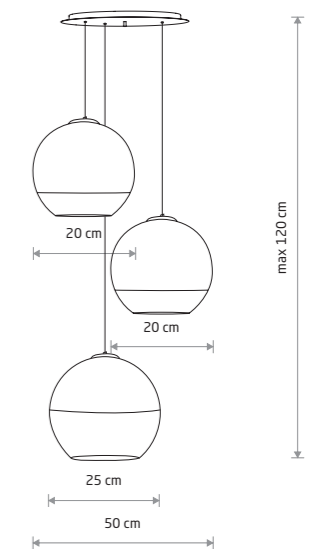

GLOBE PLUS
metallized glass, painted steel

7607

3xE27, max 25W only LED

CHROME BLACK P013 RAL 9005



SPHERE S 7847

SPHERE M 7848

SPHERE L 7850

SPHERE XL 7846

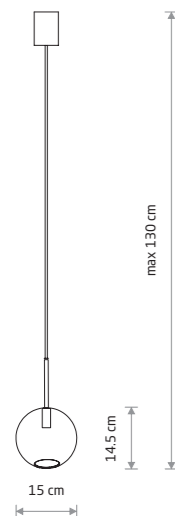
**SPHERE S**

glass, painted steel

7847

1xG9, max 10W LED

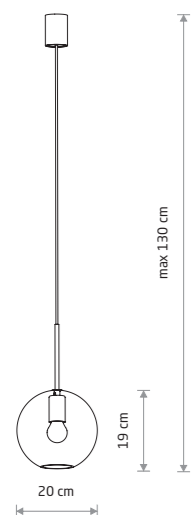
**SPHERE M**

glass, painted steel

7848

1xE27, max 25W only LED

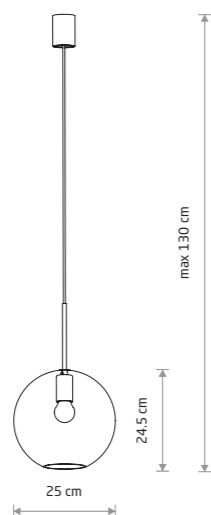
**SPHERE L**

glass, painted steel

7850

1xE27, max 25W only LED

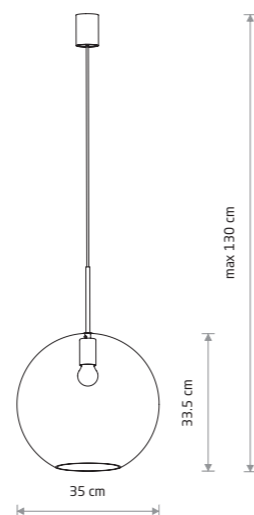
**SPHERE XL**

glass, painted steel

7846

1xE27, max 25W only LED

SPHERE 7788

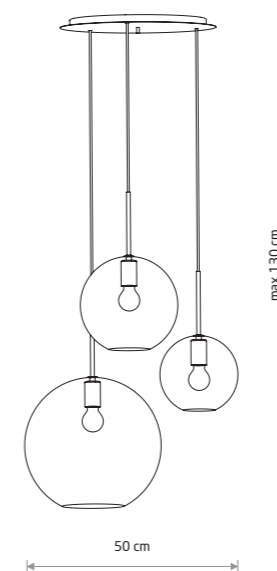
**SPHERE**

glass, painted steel

7788

3xE27, max 25W only LED



PEAR S 8673

PEAR S

glass, brass-plated steel, painted steel

8673

1xE27, max 25W only LED

glass, painted steel

7800

1xE27, max 25W only LED



PEAR M 8672

PEAR M

glass, brass-plated steel, painted steel

8672

1xE27, max 25W only LED

glass, painted steel

7798

1xE27, max 25W only LED



PEAR L 8671

PEAR L

glass, brass-plated steel, painted steel

8671

1xE27, max 25W only LED

glass, painted steel

7797

1xE27, max 25W only LED



PEAR 7794

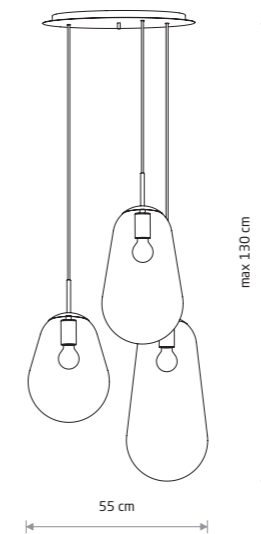

PEAR

glass, brass-plated steel, painted steel

7794

3xE27, max 25W only LED



LUXORA LED
11705

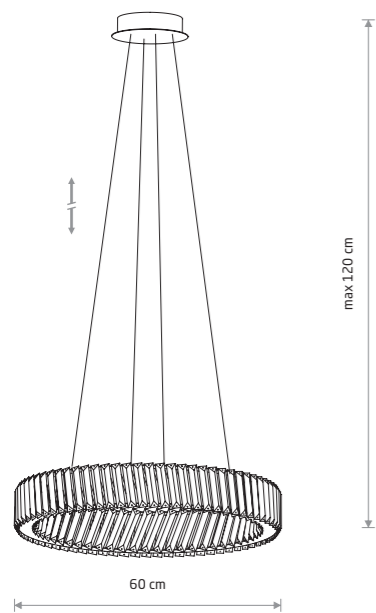

LUXORA LED

crystal, nickel

11705



LUXORA LED
11707

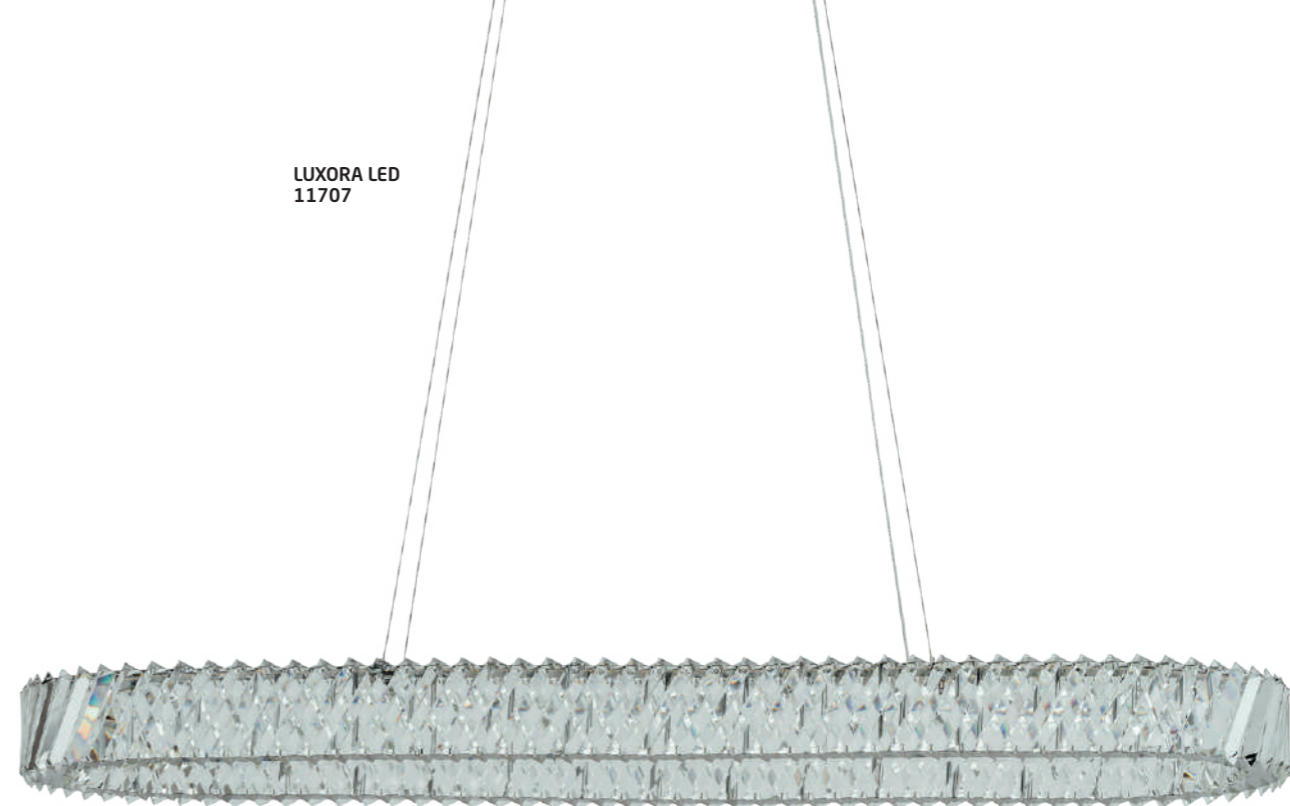

LUXORA LED

crystal, nickel

11708

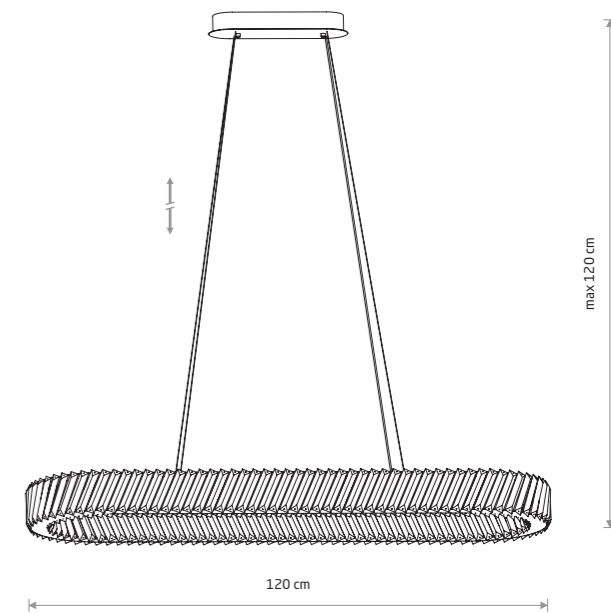

LUXORA LED

crystal, nickel

11707



Item No.	Power	Colour temp.	Luminous flux	Beam angle	Colour Rendering Index (CRI)	Input	Safety type	Power factor	Ingress protection	Lifetime
11705	30W LED	3000K	2700 lm	120°	>80	~220-230 V, 50/60 Hz	⊕	>0.9	IP20	25000h
11706	38W LED	3000K	3400 lm	120°	>80	~220-230 V, 50/60 Hz	⊕	>0.9	IP20	25000h

Item No.	Power	Colour temp.	Luminous flux	Beam angle	Colour Rendering Index (CRI)	Input	Safety type	Power factor	Ingress protection	Lifetime
11707	40W LED	3000K	3600 lm	120°	>80	~220-230 V, 50/60 Hz	⊕	>0.9	IP20	25000h
11708	20W LED	3000K	1800 lm	120°	>80	~220-230 V, 50/60 Hz	⊕	>0.9	IP20	25000h

TRANSPARENT NICKEL

TRANSPARENT NICKEL



CRISTAL M 7627

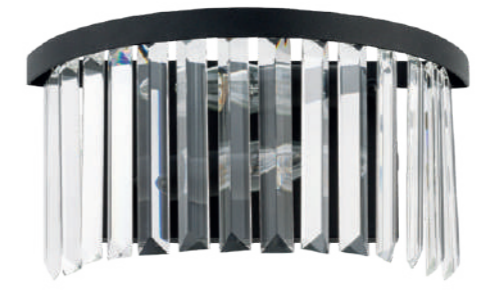

CRISTAL 7633

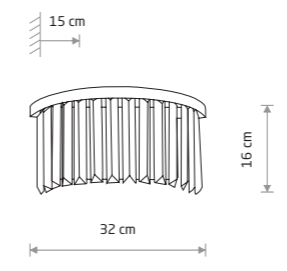

CRISTAL

crystal, painted steel

7633

2xE14, max 25W only LED

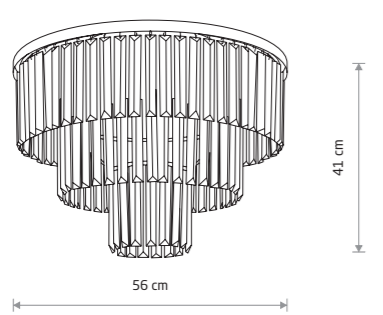

CRISTAL M

crystal, painted steel

7627

9xE14, max 25W only LED

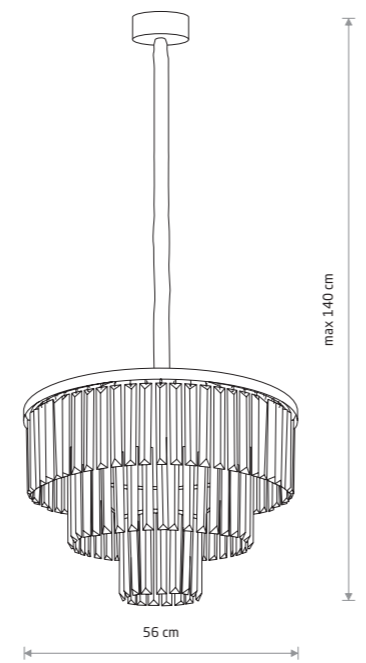

CRISTAL M

crystal, painted steel

7616

9xE14, max 25W only LED

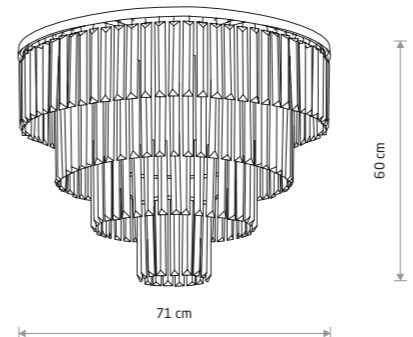

CRISTAL L

crystal, painted steel

7630

12xE14, max 25W only LED

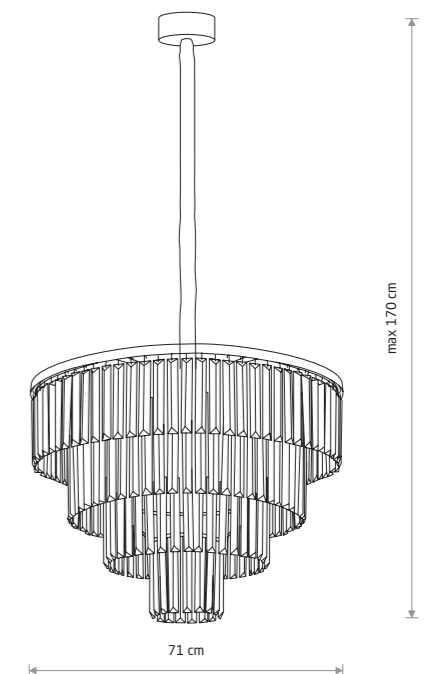

CRISTAL L

crystal, painted steel

7614

12xE14, max 25W only LED



HAMPTON 8154



HAMPTON 8155



NEWPORT 8156

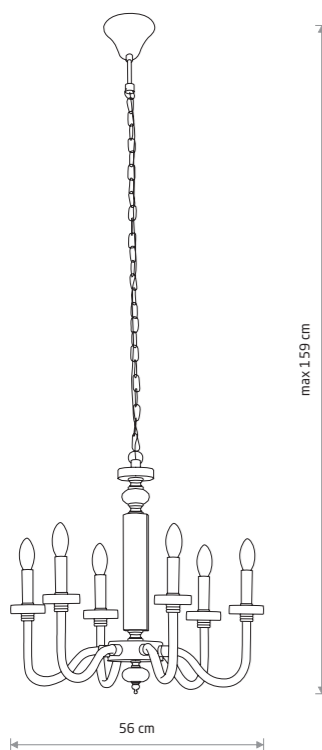

HAMPTON
chrome plated steel, glass

- 8154
- 6xE14, max 10W only LED

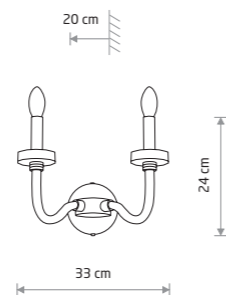

HAMPTON
chrome plated steel, glass

- 8155
- 2xE14, max 10W only LED

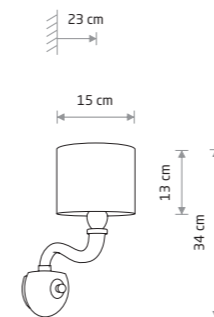

NEWPORT
glass, fabric, chrome plated steel

- 8157
- 1xE14, max 10W only LED

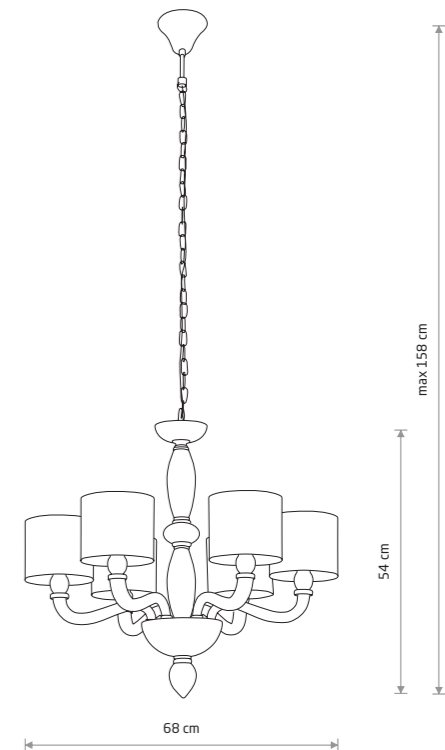

NEWPORT
glass, fabric, chrome plated steel

- 8156
- 6xE14, max 10W only LED





CERAMIC LED 11702

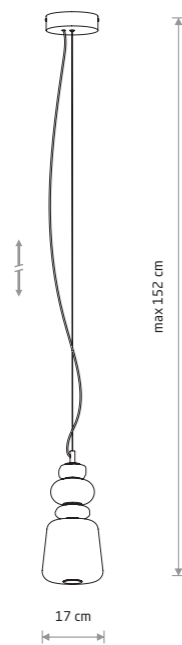

CERAMIC LED
glass, ceramic housing

▲ 11702

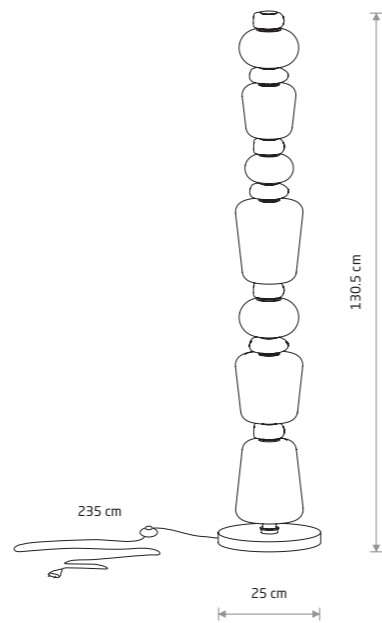

CERAMIC LED
glass, ceramic housing

▲ 11704

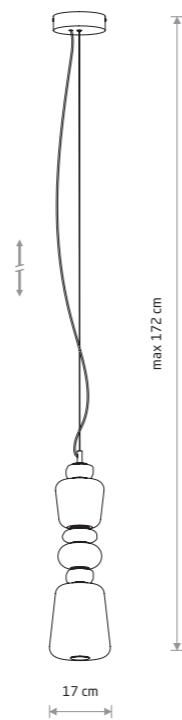

CERAMIC LED
glass, ceramic housing

▲ 11701



■ GRAY ■ BROWN ■ WHITE



CERAMIC LED 11700

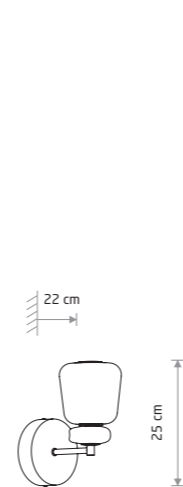

CERAMIC LED
glass, ceramic housing

▲ 11703

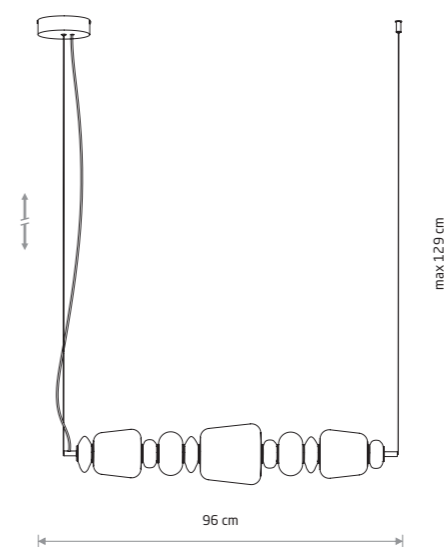

CERAMIC LED
glass, ceramic housing

▲ 11699

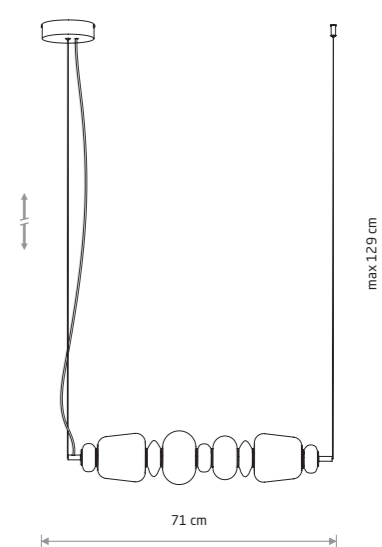

CERAMIC LED
glass, ceramic housing

▲ 11700



Item No.	Power	Colour temp.	Luminous flux	Beam angle	Colour Rendering Index (CRI)	Input	Safety type	Power factor	Ingress protection	Lifetime
11699	26W LED	3000K	2000 lm	360°	>80	~220-230 V, 50/60 Hz	⊕	>0.9	IP20	25000h
11700	22W LED	3000K	1750 lm	360°	>80	~220-230 V, 50/60 Hz	⊕	>0.9	IP20	25000h
11701	19W LED	3000K	1500 lm	360°	>80	~220-230 V, 50/60 Hz	⊕	>0.9	IP20	25000h
11702	12W LED	3000K	950 lm	360°	>80	~220-230 V, 50/60 Hz	⊕	>0.9	IP20	25000h
11703	8W LED	3000K	650 lm	360°	>80	~220-230 V, 50/60 Hz	⊕	>0.9	IP20	25000h
11704	34W LED	3000K	2700 lm	360°	>80	~220-230 V, 50/60 Hz	⊕	>0.9	IP20	25000h

■ GRAY ■ BROWN ■ WHITE

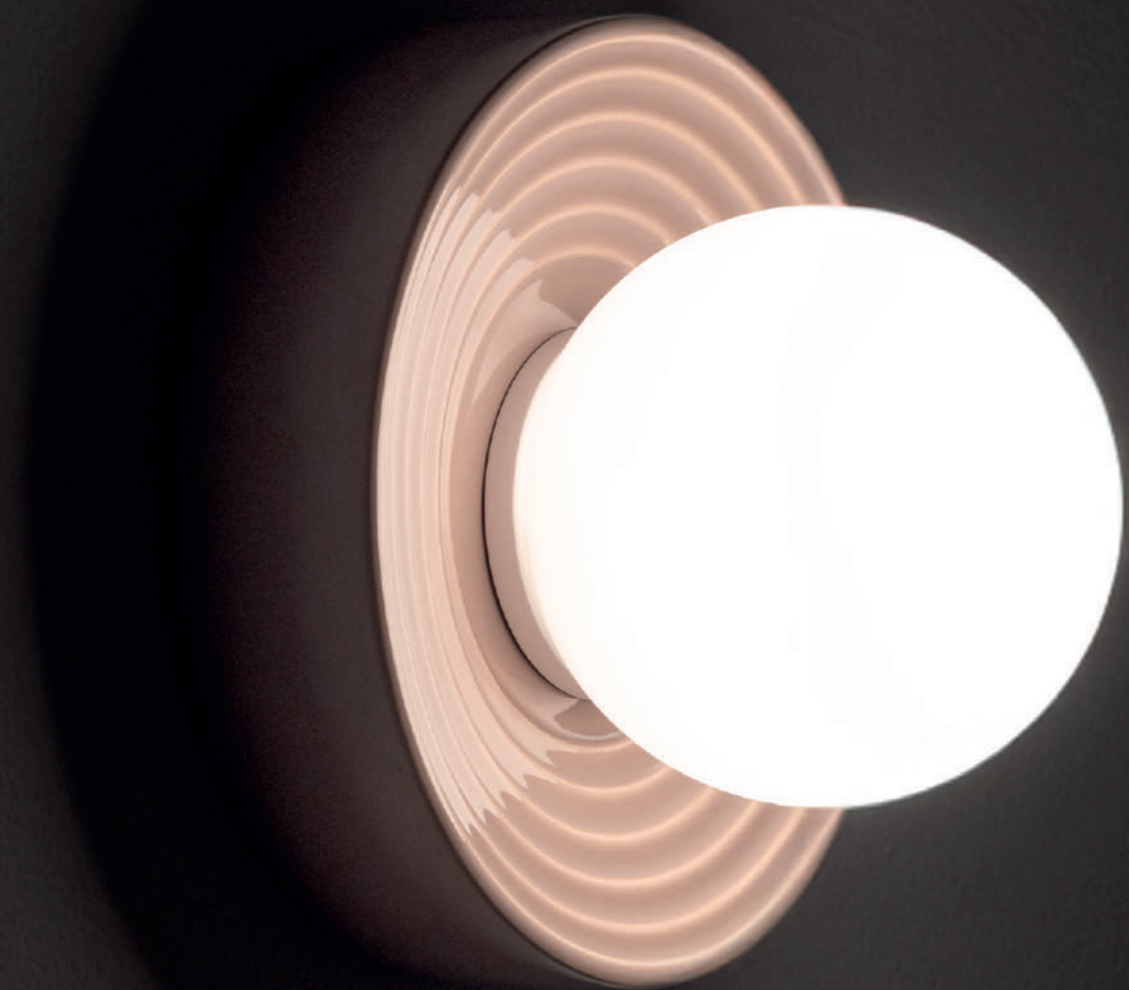

CLAY M 11746



CLAY S 11750



CLAY S 11746

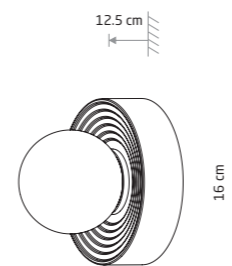

CLAY S
ceramic housing, glass

- 11748 11750

1xG9, max 12W only LED

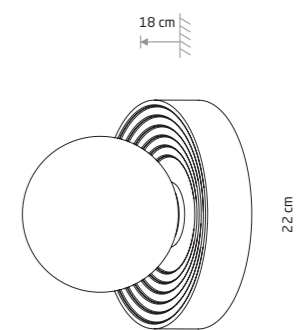

CLAY M
ceramic housing, glass

- 11746 11747

1xG9, max 12W only LED

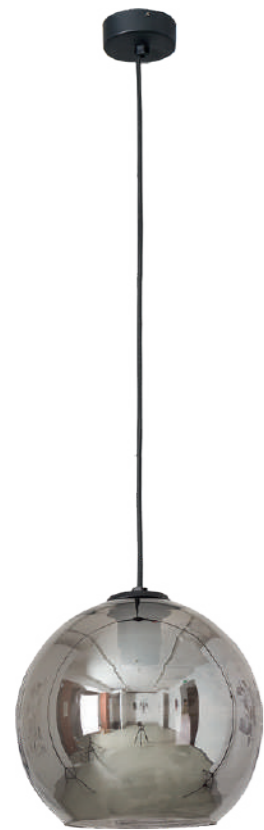

POLARIS 9060

POLARIS
metallized glass, painted steel

9060

1xE27, max 25W only LED



POLARIS 9057

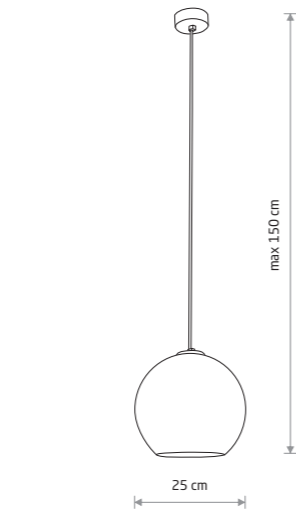

POLARIS
metallized glass, painted steel

9056 9057 9058

1xE27, max 25W only LED



POLARIS 9058



POLARIS 9056



AMALFI 9154

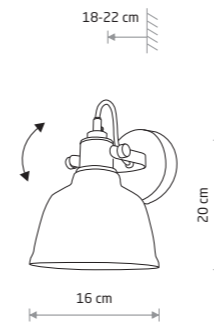

AMALFI
metallized glass, steel, solid brass

9154 9155

1xE27, max 25W only LED

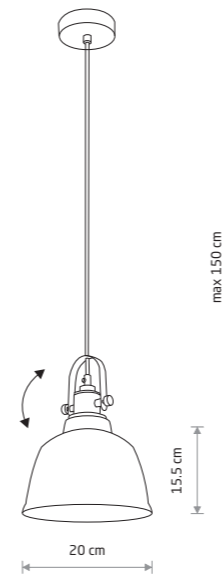

AMALFI M
metallized glass, steel, solid brass

9153 9152

1xE27, max 25W only LED

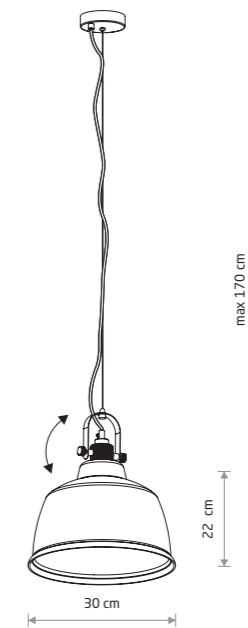

AMALFI L
metallized glass, steel, solid brass

8381

1xE27, max 25W only LED



AMALFI L 8381

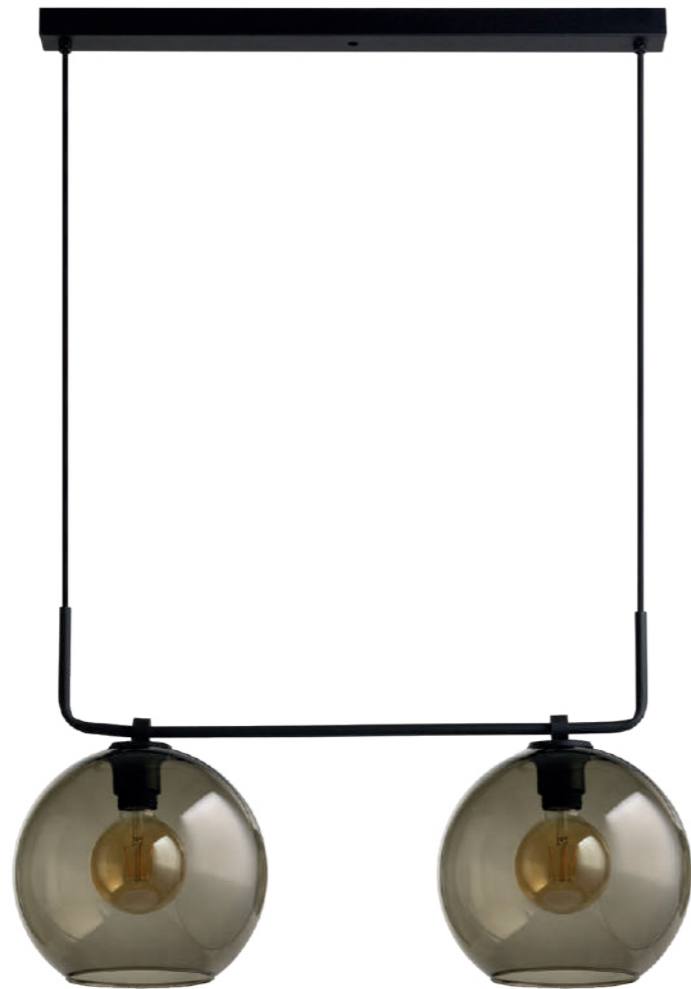

MONACO 9363

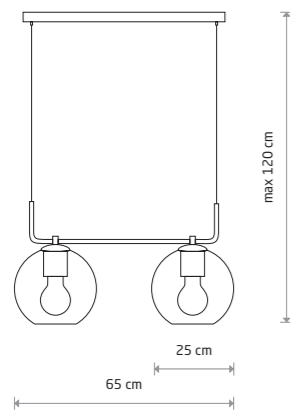

MONACO
glass, braided cable, painted steel

- 9363
- ⦿ 2xE27, max 25W only LED

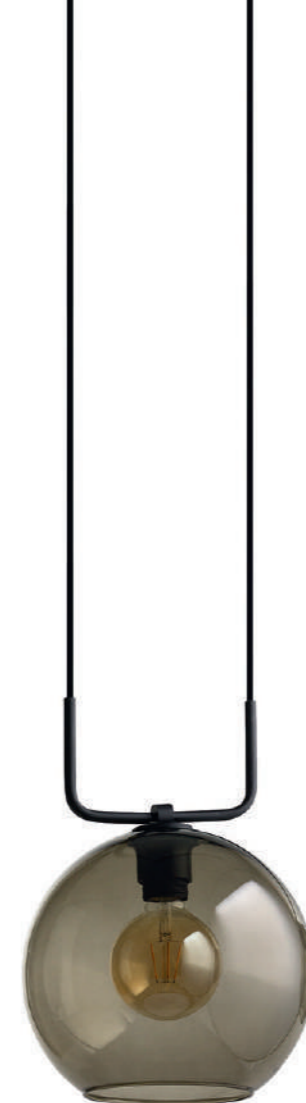

MONACO 9364

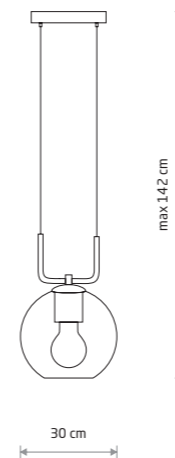

MONACO
glass, braided cable, painted steel

- 9364
- ⦿ 1xE27, max 25W only LED

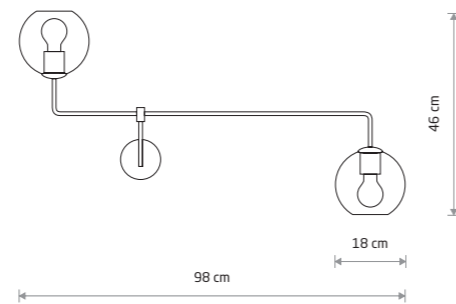

MONACO
glass, painted steel

- 9362
- ⦿ 2xE27, max 25W only LED

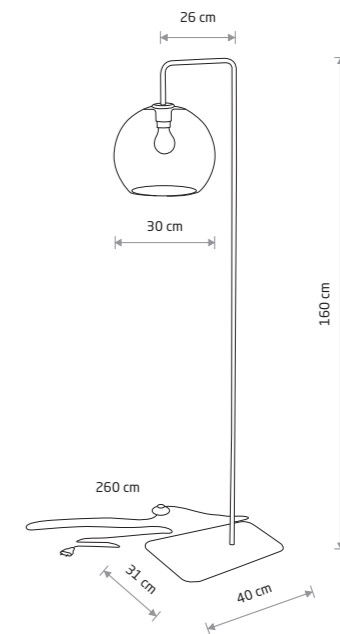

MONACO
painted steel, glass

- 8794
- ⦿ 1xE27, max 25W only LED



VETRO 7641



VETRO 7642



VETRO 9131

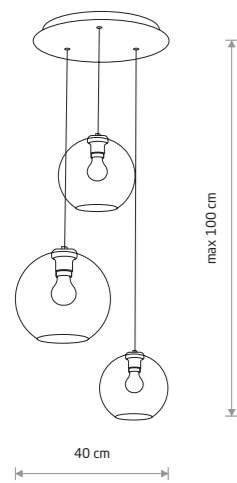

VETRO
glass, painted steel
■ 7641

● 3xE27, max 25W only LED

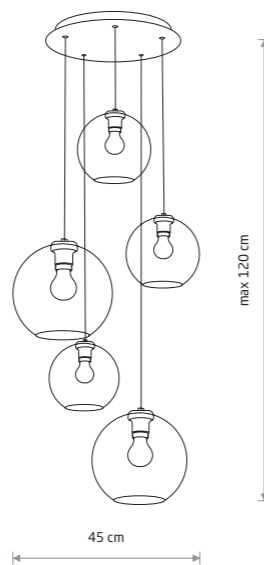

VETRO
glass, painted steel
■ 7642

● 5xE27, max 25W only LED

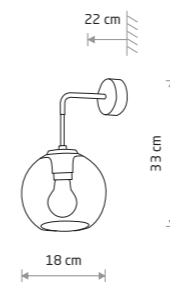

VETRO
glass, painted steel
■ 9132

● 1xE27, max 25W only LED

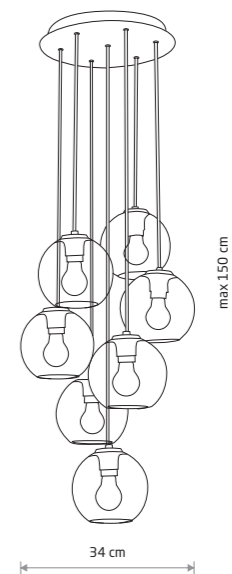

VETRO
glass, painted steel
■ 9131

● 7xE27, max 25W only LED





SANTANA S 11650

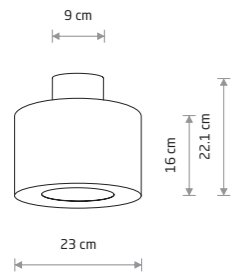

SANTANA S
fabric, painted steel, plastic

11650

1xE27, max 15W only LED



SANTANA M 11651

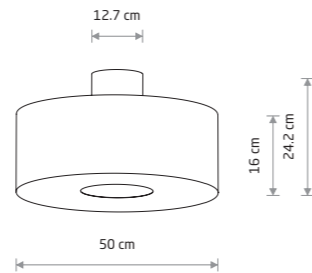

SANTANA M
fabric, painted steel, plastic

11651

1xE27, max 25W only LED

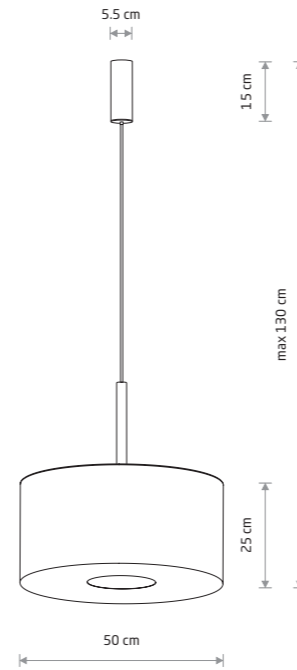

SANTANA M
fabric, painted steel, plastic

11652

1xE27, max 25W only LED

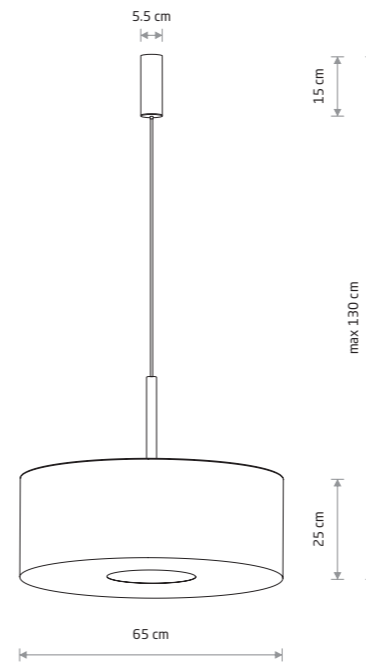

SANTANA L
fabric, painted steel, plastic

11653

1xE27, max 25W only LED



SANTANA M 11652

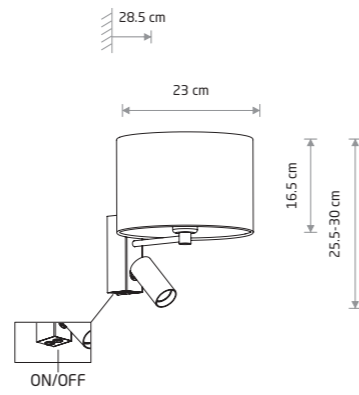

SANTANA A 11654

**SANTANA A**

fabric, painted steel

■ 11654

■ 1x E27, 1x GU10 R35 max 10W only LED

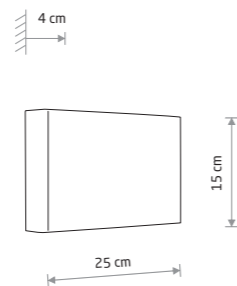

SANTANA B 11655

**SANTANA B**

fabric, painted steel

■ 11655

■ 2x G9, max 10W only LED

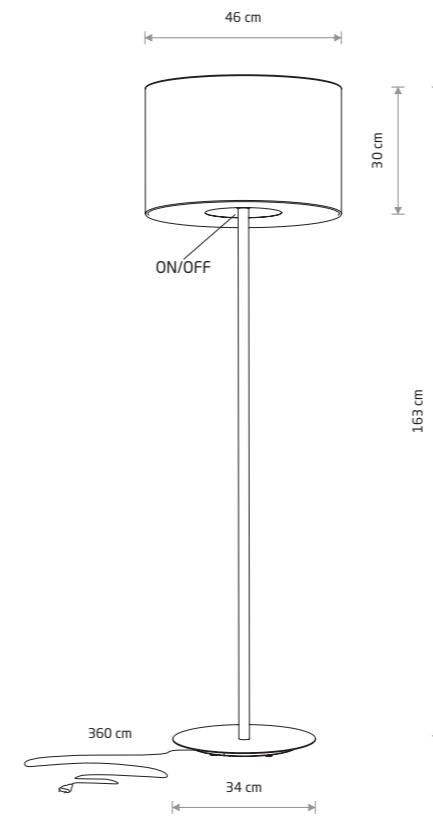
**SANTANA**

fabric, painted steel, plastic

■ 11656

■ 1x E27, max 25W only LED

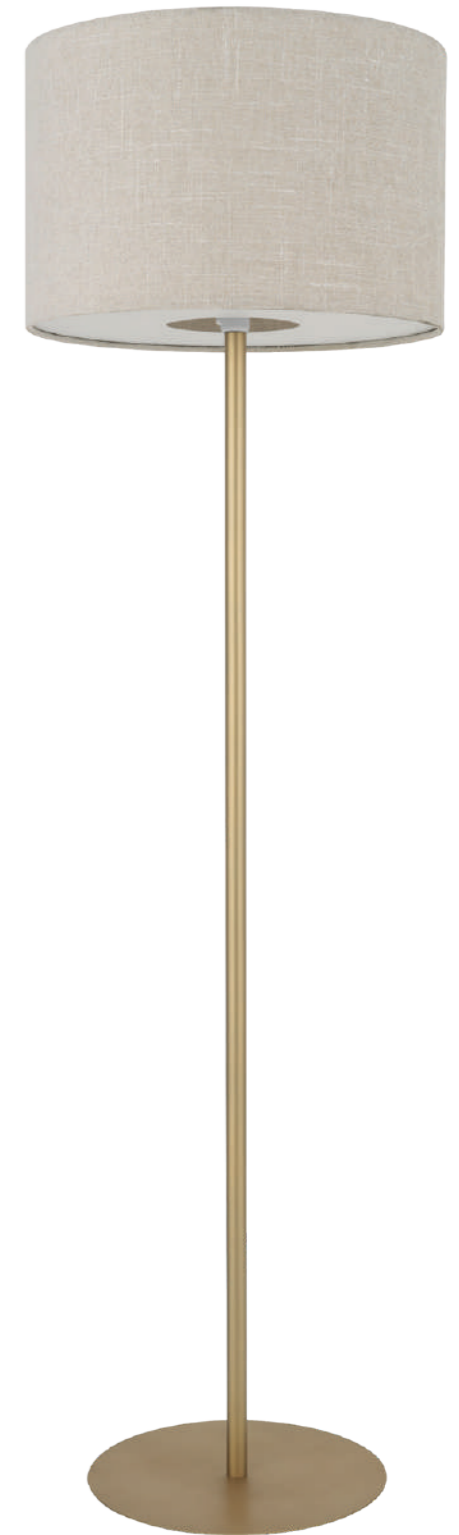

SANTANA 11656



AMARELA S 11657



AMARELA M 11658



AMARELA L 11660

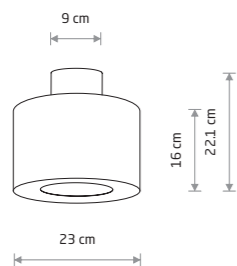

AMARELA S
fabric, painted steel, plastic

■ 11657

1xE27, max 15W only LED

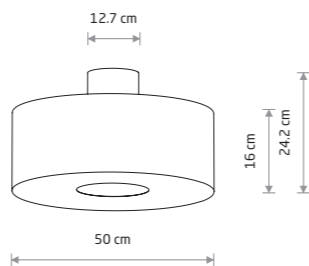

AMARELA M
fabric, painted steel, plastic

■ 11658

1xE27, max 25W only LED

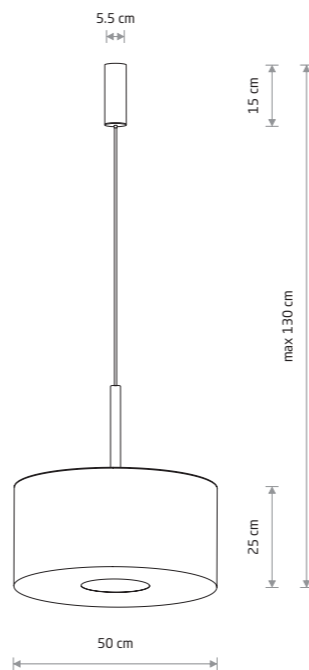

AMARELA M
fabric, painted steel, plastic

■ 11659

1xE27, max 25W only LED

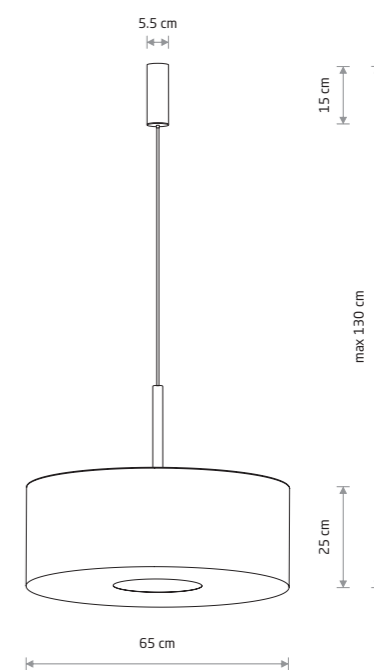

AMARELA L
fabric, painted steel, plastic

■ 11660

1xE27, max 25W only LED



AMARELA A 11661

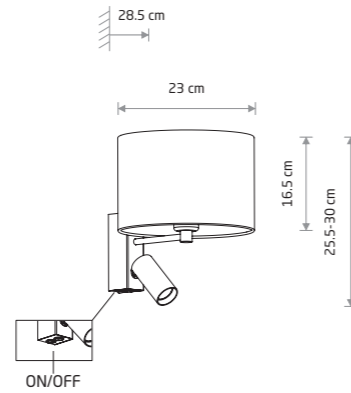

AMARELA A

fabric, painted steel

■ 11661

🔌 1xE27, 1x GU10 R35 max 10W only LED



AMARELA B 11662

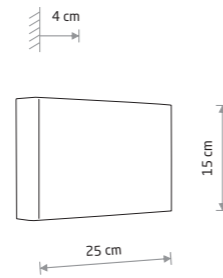

AMARELA B

fabric, painted steel

■ 11662

🔌 2xG9, max 10W only LED

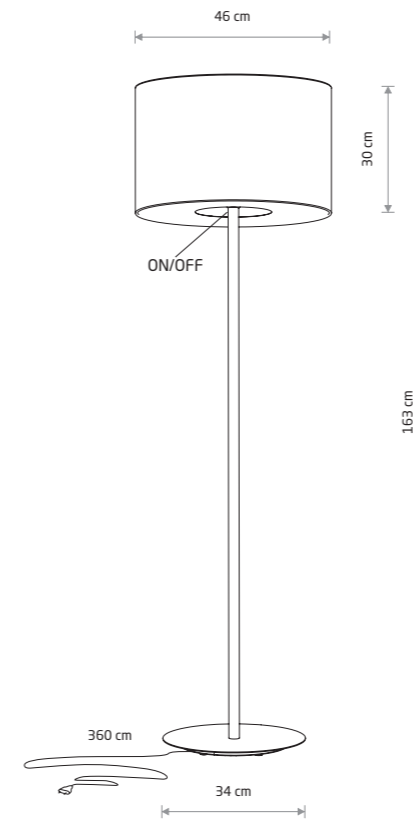

AMARELA

fabric, painted steel, plastic

■ 11663

🔌 1xE27, max 25W only LED

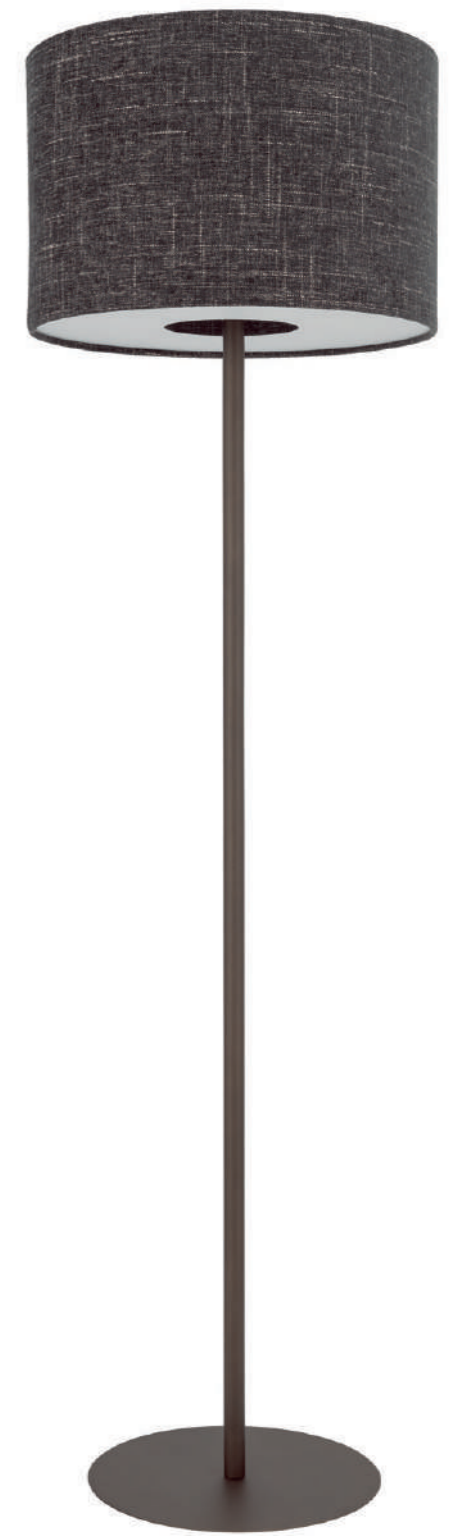

AMARELA 11663



CEDRO M 11665

AMY LED 11533

CEDRO B 11669



Ballerina included

CEDRO M 11665



CEDRO S 11670



CEDRO M 11671

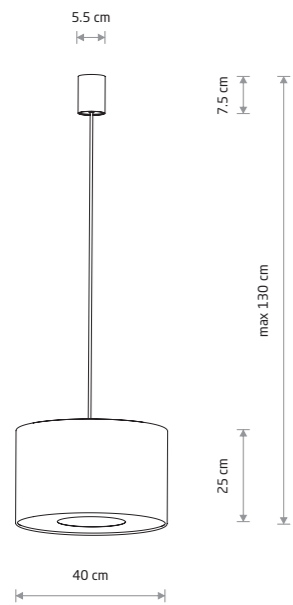

CEDRO S
fabric, painted steel, plastic

■ 11664

● 1xE27, max 15W only LED

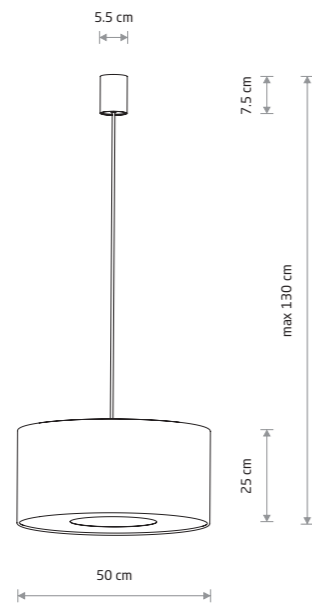

CEDRO M
fabric, painted steel, plastic

■ 11665

● 1xE27, max 25W only LED

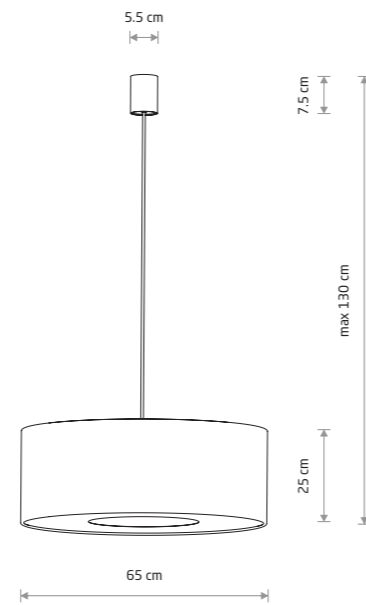

CEDRO L
fabric, painted steel, plastic

■ 11666

● 1xE27, max 25W only LED

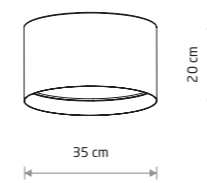

CEDRO S
fabric, plastic

■ 11670

● 2xE27, max 15W only LED

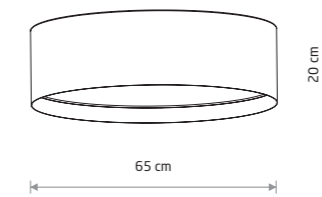

CEDRO M
fabric, plastic

■ 11671

● 4xE27, max 15W only LED

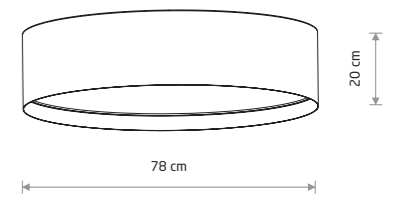

CEDRO L
fabric, plastic

■ 11672

● 7xE27, max 15W only LED



CEDRO A 11668

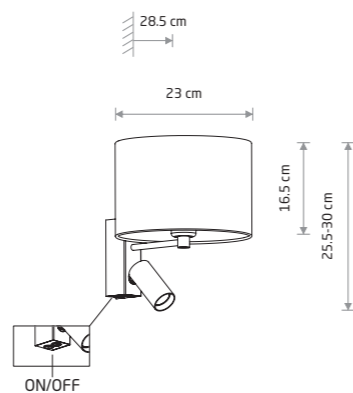

CEDRO A
fabric, painted steel

■ 11668

🔌💡 1xE27, 1x GU10 R35 max 10W only LED



CEDRO B 11669

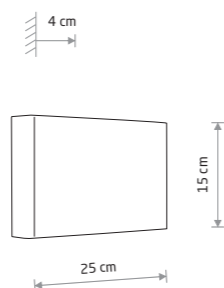

CEDRO B
fabric, painted steel

■ 11669

🔌💡 2xG9, max 10W only LED

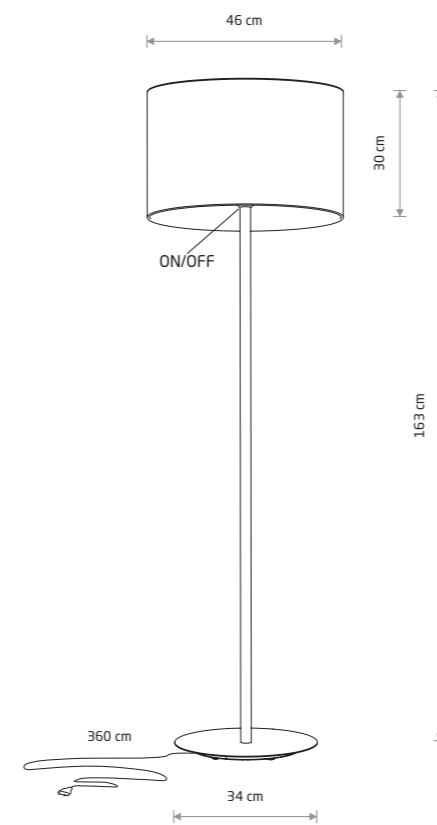

CEDRO
fabric, painted steel

■ 11667

🔌💡 1xE27, max 25W only LED



CEDRO 11667



LAGO L 11681



CEDRO S 11670



LAGO 11676





Acrobat included



LAGO S 11673



LAGO M 11674



LAGO M 11680



LAGO L 11681

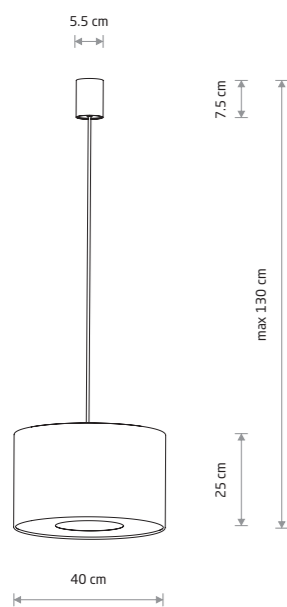

LAGO S

fabric, painted steel, plastic

■ 11673

🔌 1xE27, max 15W only LED

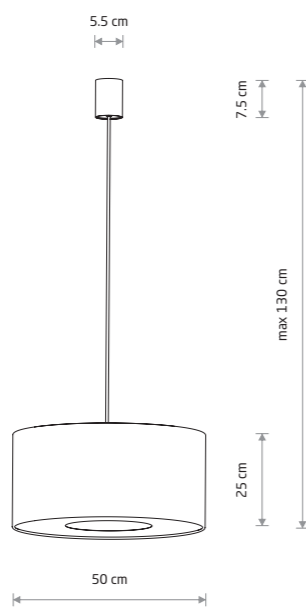

LAGO M

fabric, painted steel, plastic

■ 11674

🔌 1xE27, max 25W only LED

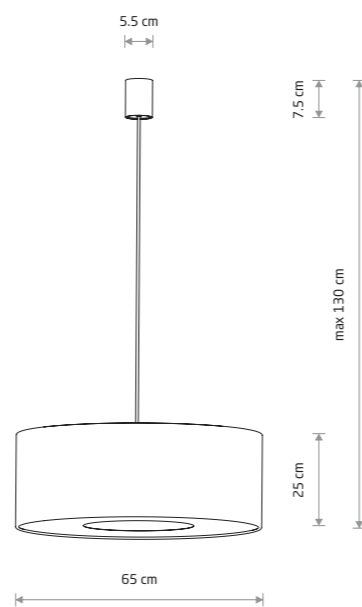

LAGO L

fabric, painted steel, plastic

■ 11675

🔌 1xE27, max 25W only LED

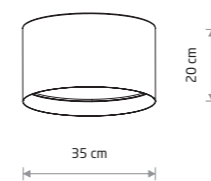

LAGO S

fabric, plastic

■ 11679

🔌 2xE27, max 15W only LED

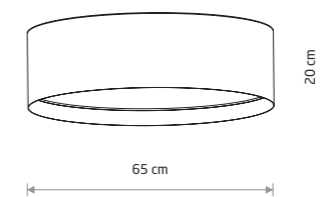

LAGO M

fabric, plastic

■ 11680

🔌 4xE27, max 15W only LED

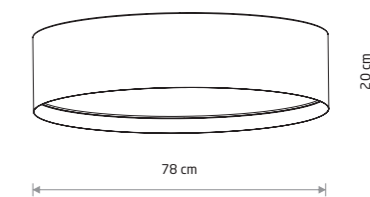

LAGO L

fabric, plastic

■ 11681

🔌 7xE27, max 15W only LED



LAGO A 11677

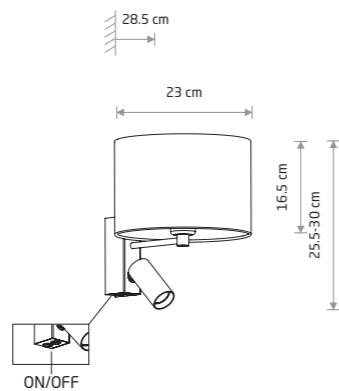

LAGO A

fabric, painted steel

■ 11677

🔌 1xE27, 1x GU10 R35 max 10W only LED



LAGO B 11678

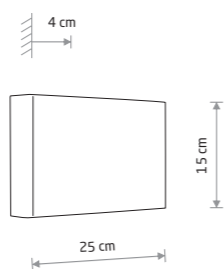

LAGO B

fabric, painted steel

■ 11678

🔌 2xG9, max 10W only LED

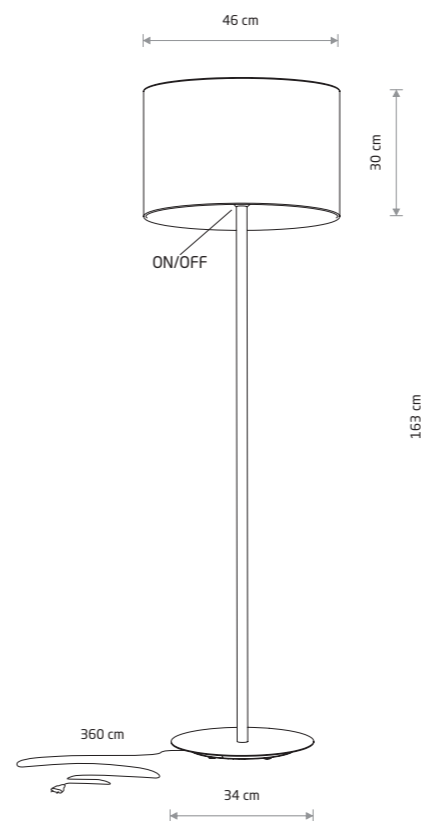

LAGO

fabric, painted steel

■ 11676

🔌 1xE27, max 25W only LED



LAGO 11676



TUTOIA 11684

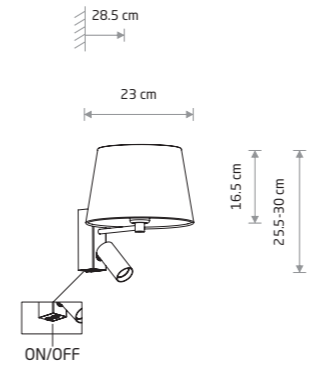

TUTOIA

fabric, painted steel

■ 11684

🔌 1xE27, 1x GU10 R35 max 10W only LED

TUTOIA 11683

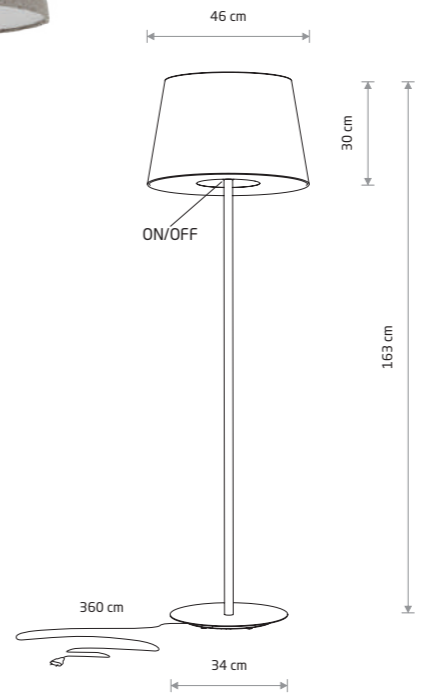

TUTOIA

fabric, painted steel, plastic

■ 11683

🔌 1xE27, max 25W only LED

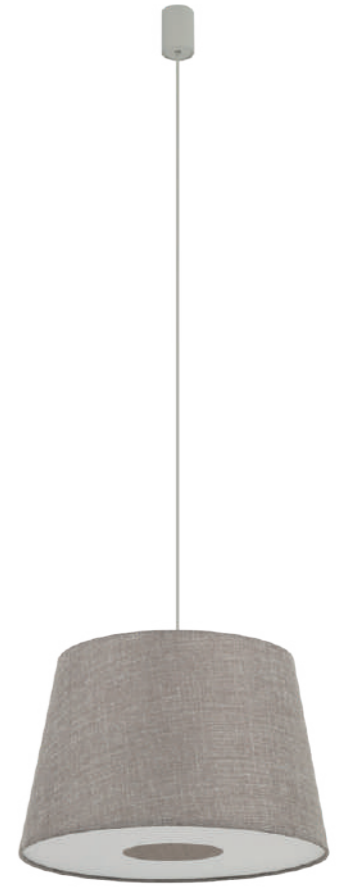

TUTOIA 11682

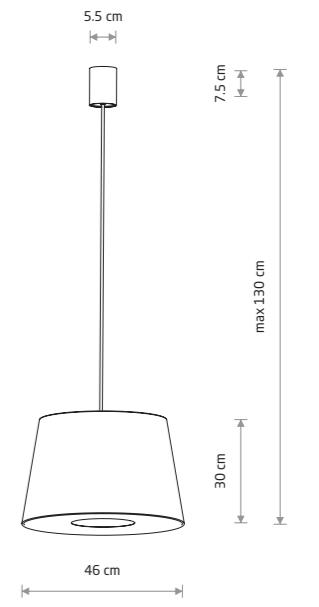

TUTOIA

fabric, painted steel, plastic

■ 11682

🔌 1xE27, max 25W only LED

■ BEIGE T036 ■ SILK GRAY P026 RAL 7044

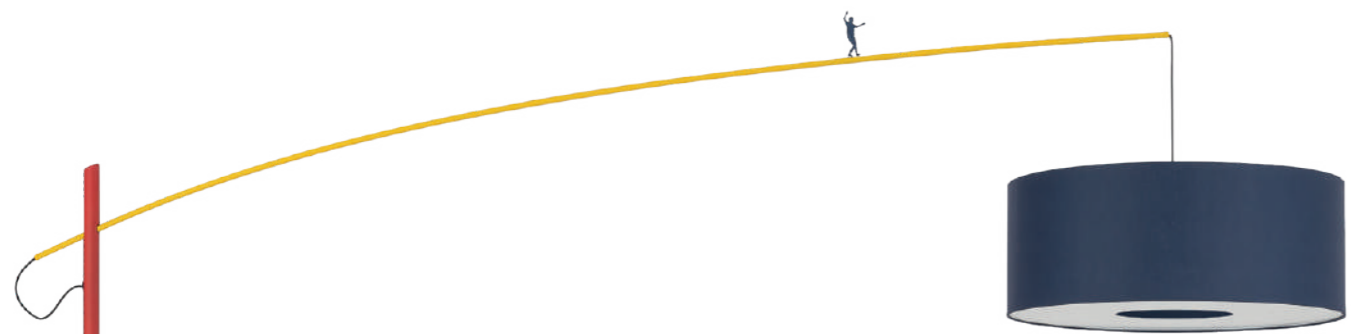

POISE B 11430



Acrobat included

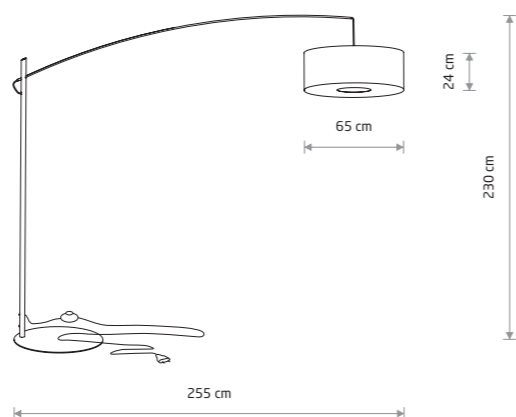
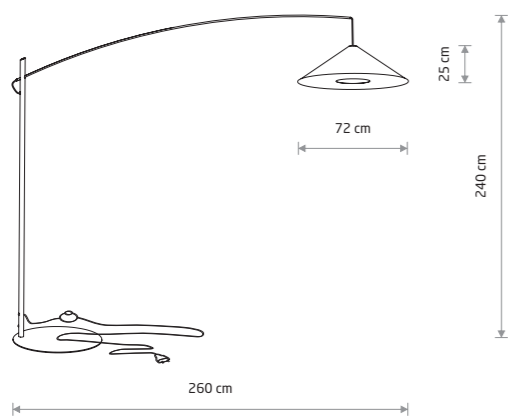

POISE A

fabric, painted steel, plastic

■ 11686 ■ 11767 ■ 11768

🔌 1xE27, max 25W only LED

POISE B

fabric, painted steel, plastic

■ 11430 ■ 11685

🔌 1xE27, max 25W only LED

- NAVY BLUE T039
- RED P033 RAL 3020
- YELLOW P032 RAL 1021
- BEIGE T034
- GRAY T035
- BLACK T011
- BLACK P013 RAL 9005
- SILK GRAY P026 RAL 7044
- UMBRA GRAY P027 RAL 7022



POISE A 11767



TURDA 8802



TURDA 8802



Visualisation by Iwona Ligęza



TURDA 8952



TURDA 8958



TURDA 8955



TURDA 8802

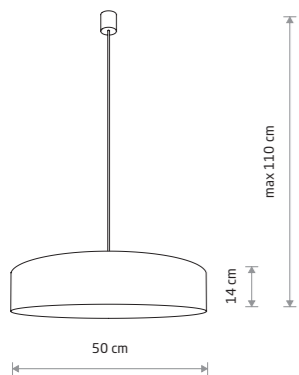

TURDA
fabric, plastic, painted steel

8945
3xE27, max 15W only LED

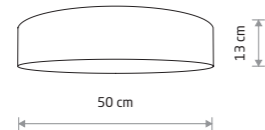

TURDA
fabric, plastic, painted steel

8952
3xE27, max 15W only LED

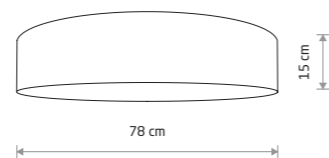

TURDA
fabric, plastic, painted steel

8958
7xE27, max 15W only LED

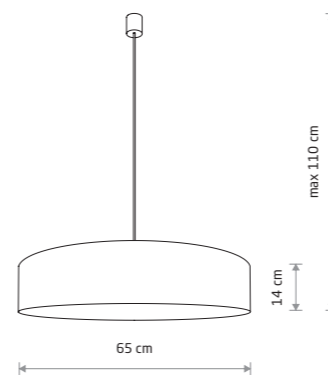

TURDA
fabric, plastic, painted steel

8950
3xE27, max 15W only LED

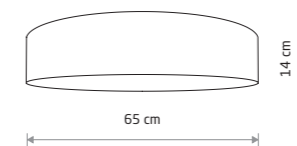

TURDA
fabric, plastic, painted steel

8955
4xE27, max 15W only LED

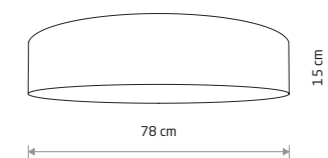

TURDA
fabric, plastic, painted steel

8802
7xE27, max 15W only LED



TURDA 8946



TURDA 8947



LAGUNA 8962



LAGUNA 8954

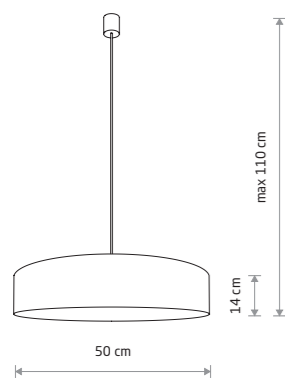

TURDA
fabric, plastic, painted steel

■ 8946

⦿ 3xE27, max 15W only LED

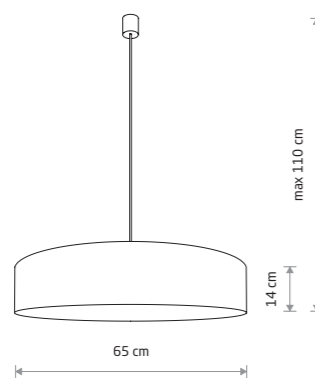

TURDA
fabric, plastic, painted steel

■ 8947

⦿ 3xE27, max 15W only LED

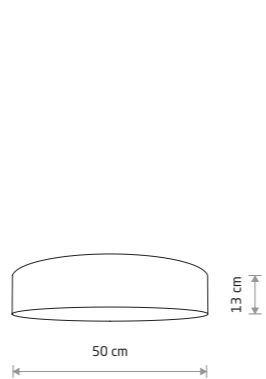

TURDA
fabric, plastic, painted steel

■ 8953

⦿ 3xE27, max 15W only LED

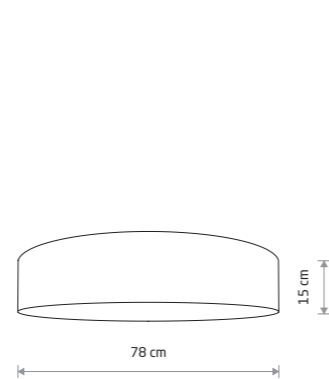

TURDA
fabric, plastic, painted steel

■ 8960

⦿ 7xE27, max 15W only LED

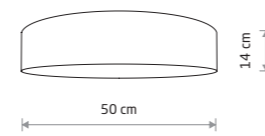

LAGUNA
velvet, plastic, painted steel

■ 8954

⦿ 3xE27, max 15W only LED

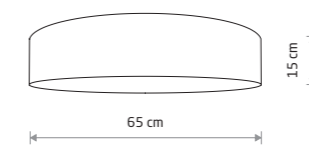

LAGUNA
velvet, plastic, painted steel

■ 8957

⦿ 4xE27, max 15W only LED

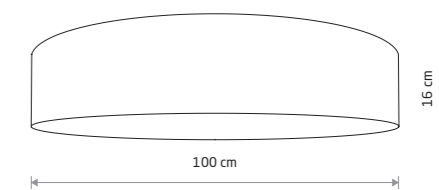

LAGUNA
velvet, plastic, painted steel

■ 8962

⦿ 9xE27, max 15W only LED

CADILAC 7988

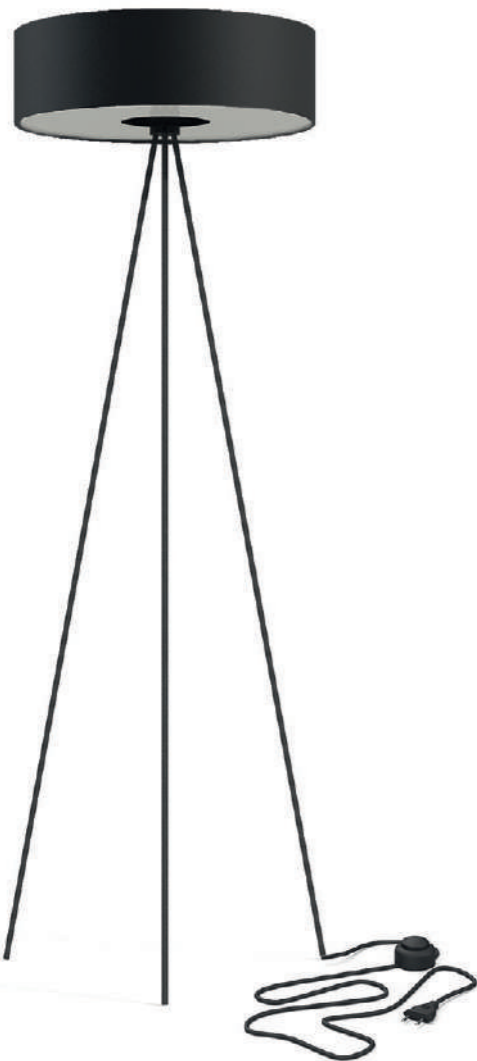

CADILAC 8190

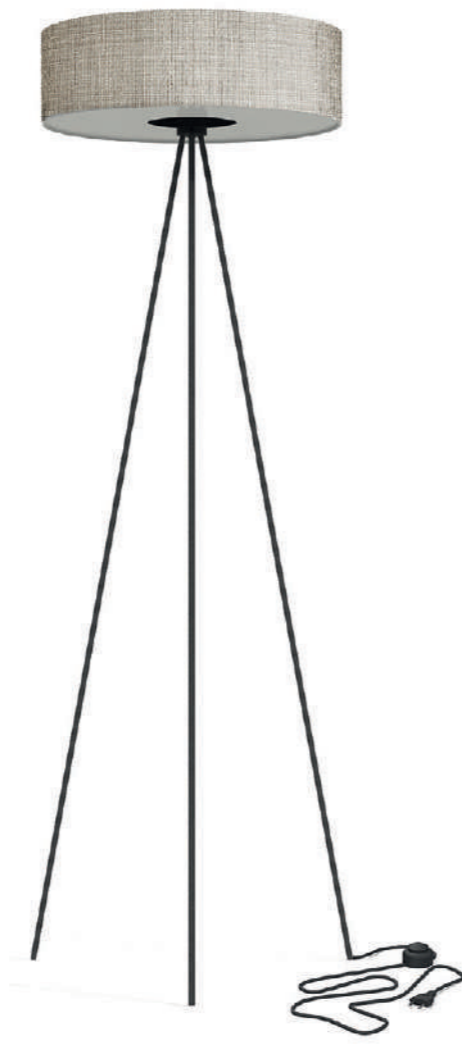

CADILAC 7991

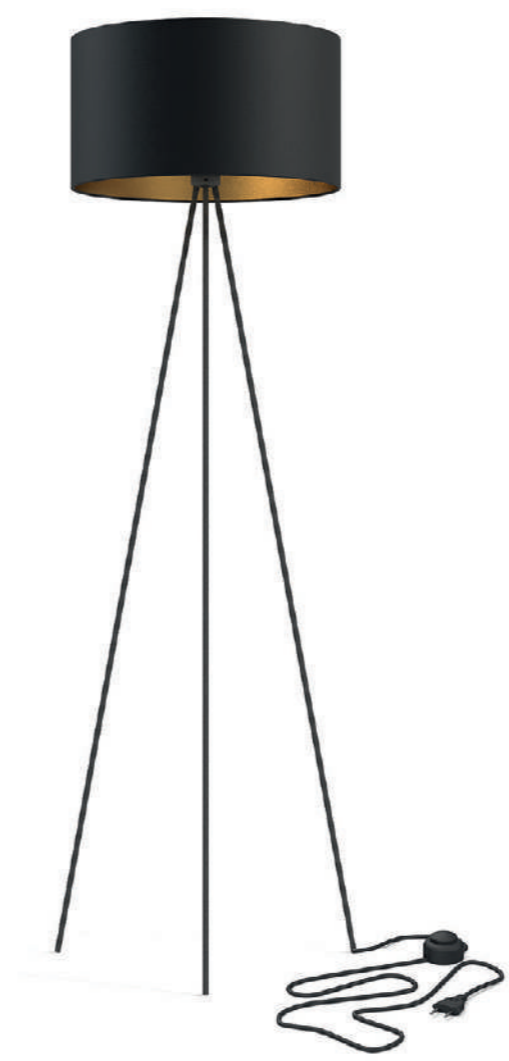

CADILAC 8191

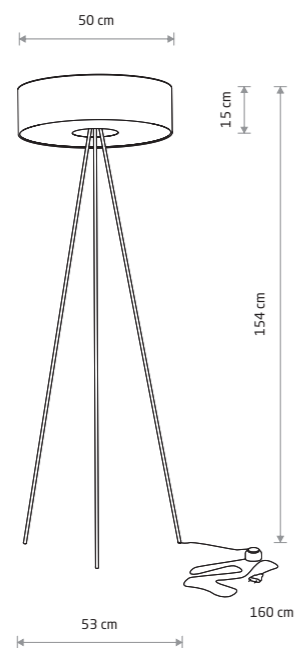
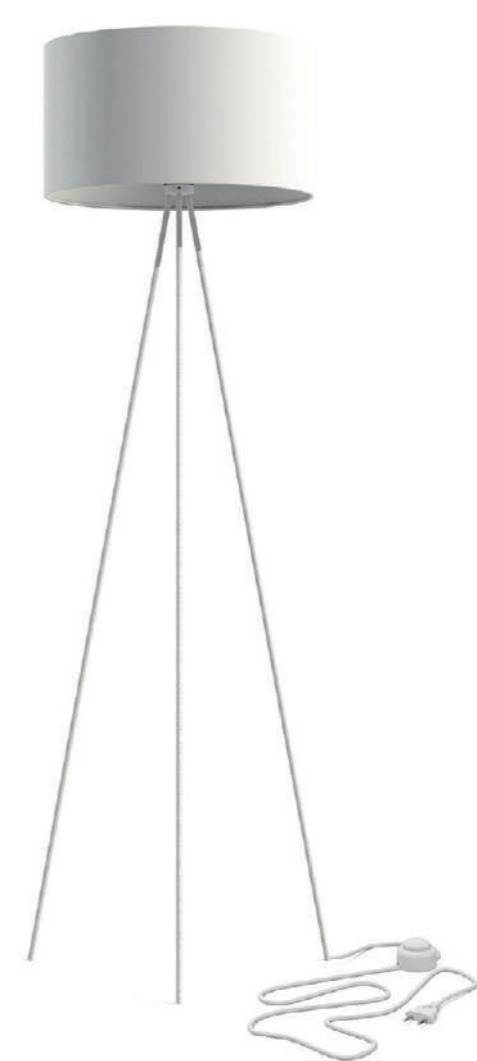

CADILAC

fabric, painted steel, plastic

- 7988
- 8190

3xE27, max 25W only LED

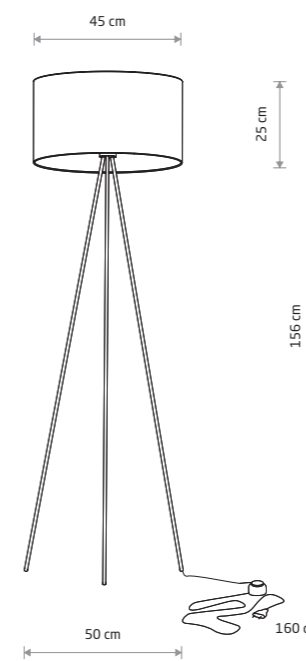

CADILAC

fabric, painted steel

- 7991
- 8191

1xE27, max 25W only LED



MIST 8944



MIST 8943



MIST 8942



FORM L 9672



FORM M 9673

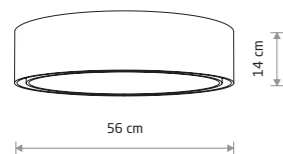

MIST
fabric, plastic, painted steel

- 8943
- 3xE27, max 15W only LED

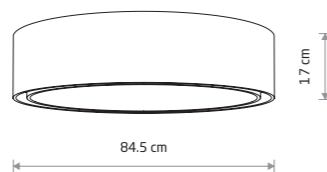

MIST
fabric, plastic, painted steel

- 8944
- 7xE27, max 15W only LED

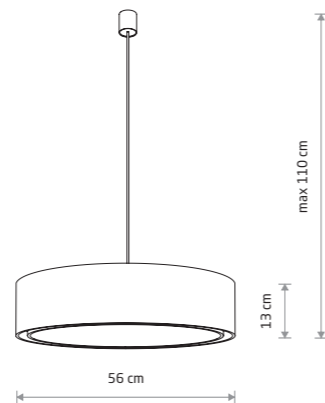

MIST
fabric, plastic, painted steel

- 8942
- 3xE27, max 15W only LED

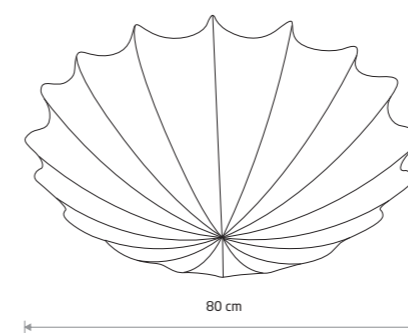

FORM L
fabric, painted steel

- 9672
- 4xE27, max 25W only LED

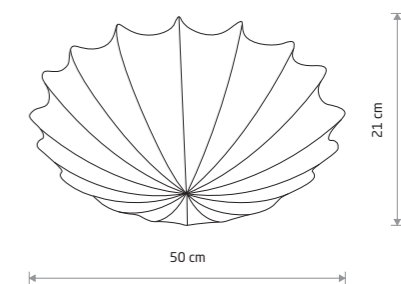

FORM M
fabric, painted steel

- 9673
- 2xE27, max 25W only LED



CAMERON 9606



CAMERON 9605



CAMERON 9687



CAMERON 9682

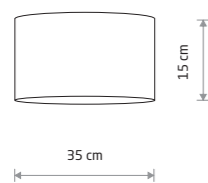

CAMERON
fabric, plastic, painted steel

9605

2xE27, max 15W only LED

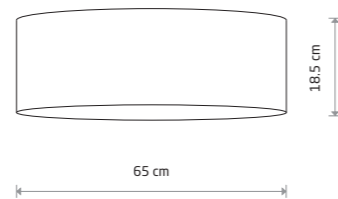

CAMERON
fabric, plastic, painted steel

9606

4xE27, max 15W only LED

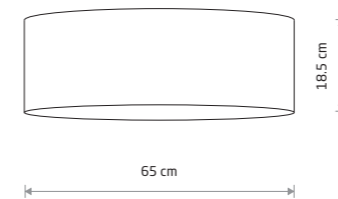

CAMERON
fabric, plastic, painted steel

9682

4xE27, max 15W only LED

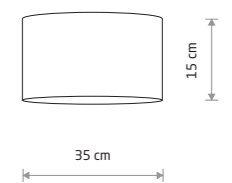

CAMERON
fabric, plastic, painted steel

9687

2xE27, max 15W only LED



VIVIANE 6772



VIVIANE 6773



VIOLET 7958



VIOLET 7960



VIVIANE 6390



VIOLET 7961

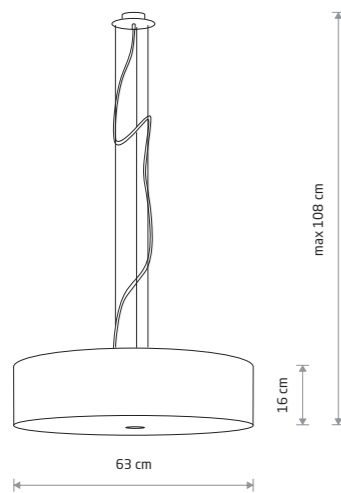

VIVIANE

fabric, glass, chrome

6772 6773 6774

3xE27, max 25W only LED

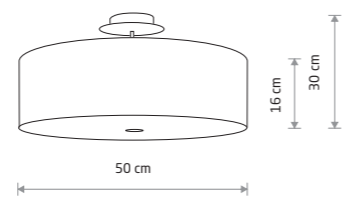

VIVIANE

fabric, glass, chrome

6391 6532 6390

3xE27, max 25W only LED

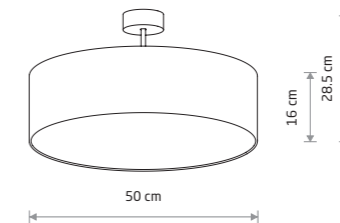

VIOLET

fabric, plastic, painted steel

7958 7960 7961

3xE27, max 25W only LED

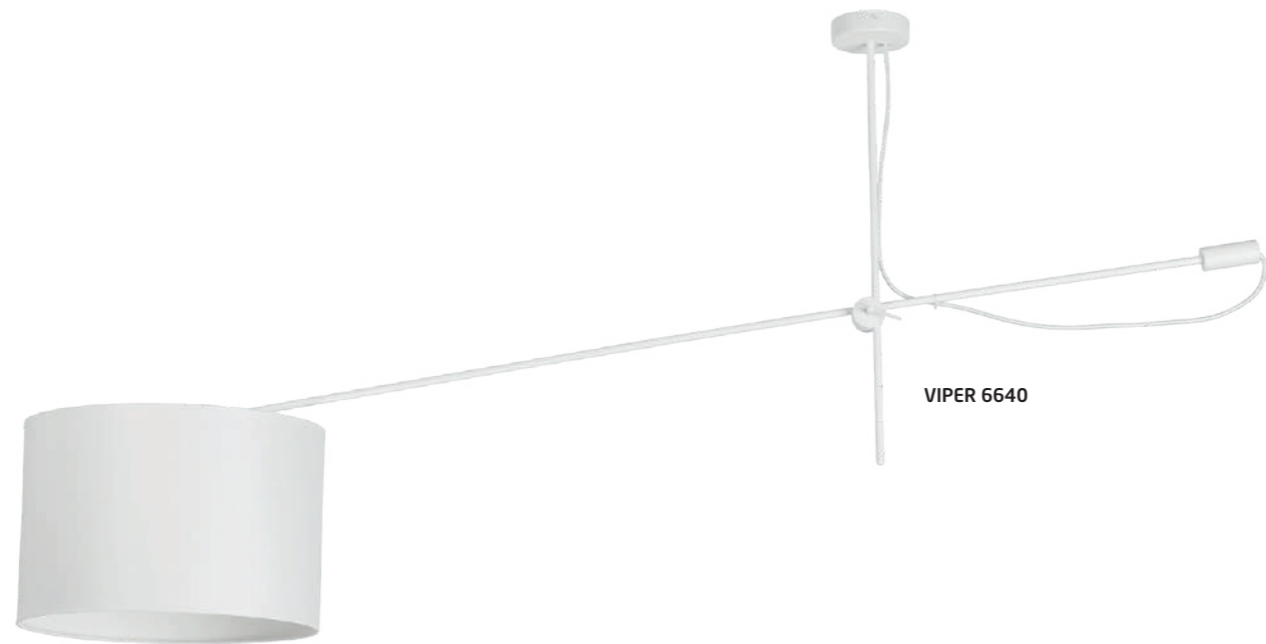

VIPER 6640

VIPER

fabric, painted steel

6640 6641

1xE27, max 25W only LED

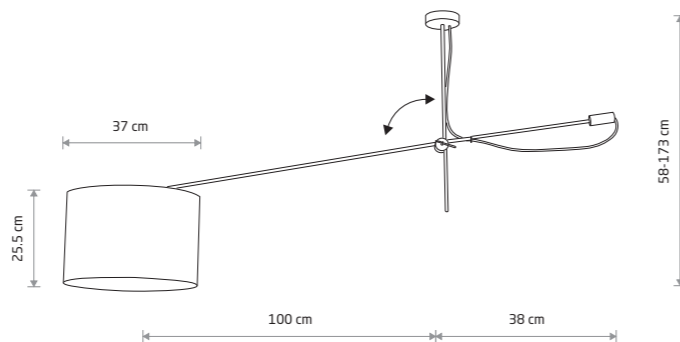

FALCON 7950

FALCON

fabric, plastic, painted steel

7951 7950

6xE27, max 25W only LED

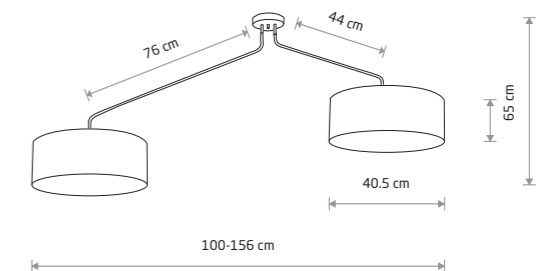
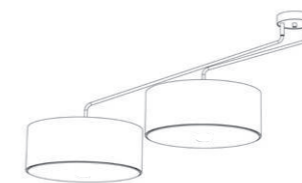

VIPER

fabric, painted steel, chrome

6512 6513

1xE14, max 10W only LED

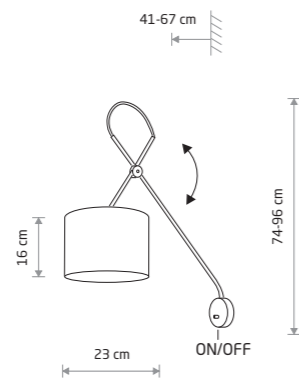

VIPER 6513



ALICE 9091

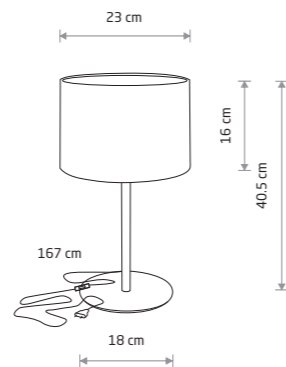

ALICE
fabric, painted steel

9091

1xE27, max 10W only LED

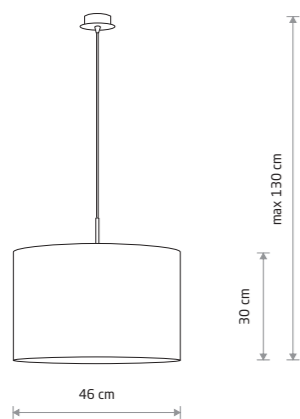

ALICE L
fabric, painted steel

4961

1xE27, max 25W only LED

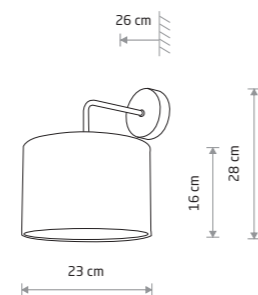

ALICE
fabric, painted steel

9084

1xE27, max 10W only LED



ALICE 4963

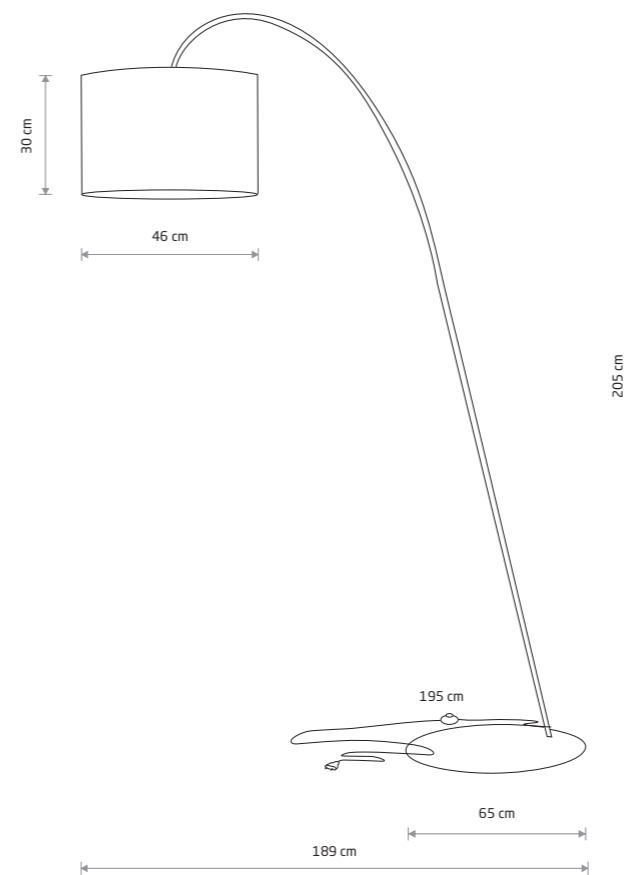

ALICE L
painted steel, fabric

4963

1xE27, max 25W only LED



HOTEL MOOD 11788

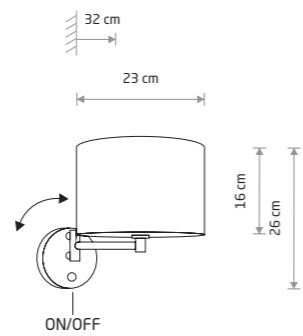

HOTEL MOOD

fabric, chrome plated steel

11781 11788

1xE14, max 10W only LED

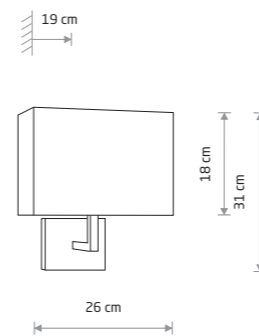

HOTEL MOOD

fabric, chrome plated steel

11780 11787

1xE27, max 10W only LED



HOTEL MOOD 11787



HOTEL MOOD LED 11793

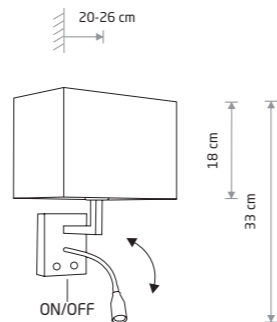

HOTEL MOOD LED

fabric, chrome plated steel

11785 11793

1xE27, max 10W only LED, 1x2.2W LED

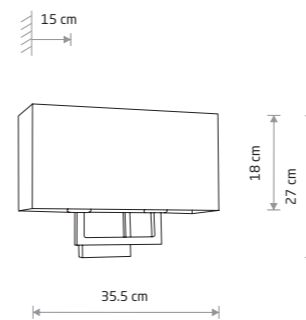

HOTEL MOOD

fabric, chrome plated steel

11784 11792

2xE27, max 10W only LED



HOTEL MOOD 11792



HOTEL MOOD
11783

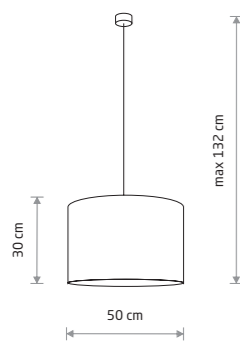

HOTEL MOOD

fabric, chrome plated steel, plastic

■ 11783 ■ 11791

● 1xE27, max 25W only LED



HOTEL MOOD
11778

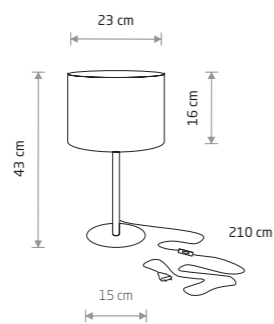

HOTEL MOOD

fabric, painted steel

■ 11778 ■ 11786

● 1xE27, max 10W only LED



HOTEL MOOD
11782

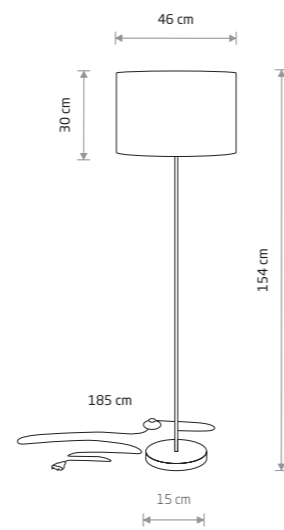

HOTEL MOOD

fabric, painted steel, plastic

■ 11782 ■ 11790

● 1xE27, max 25W only LED



HOTEL MOOD 11791

■ GRAY T038 ■ CREAM T037 ■ CHROME

HOTEL PLUS
9071

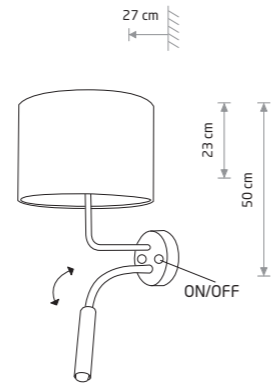

HOTEL PLUS

fabric, painted steel, flexible stem

■ 9071

🔌 1xE27, max 10W only LED, 1xG9, max 10W only LED



HOTEL PLUS
9072

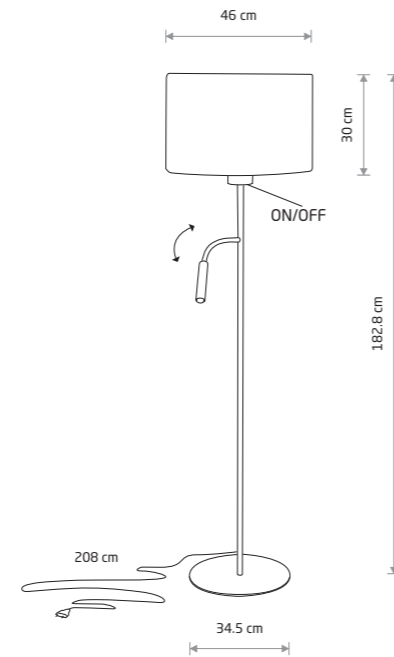

HOTEL PLUS

fabric, painted steel, flexible stem

■ 9072

🔌 1xE27, max 25W only LED, 1xG9, max 10W only LED

MOSS 9737



MOSS

fabric, plywood, painted steel

■ 9736

🔌 3xE27, max 25W only LED

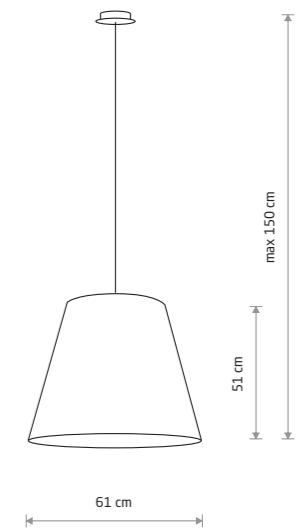

MOSS

fabric, painted steel

■ 9737

🔌 3xE27, max 25W only LED

CHILLIN 8213



CHILLIN 8197



CHILLIN 8201

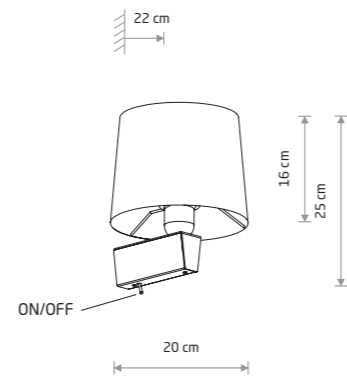
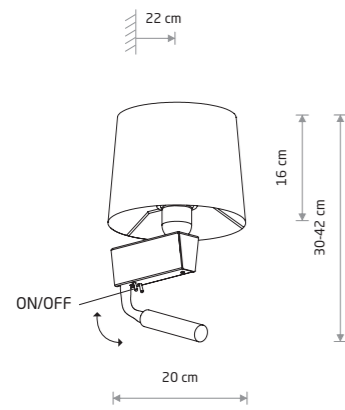

CHILLIN

fabric, painted steel, flexible stem

8216

1xE27, max 10W only LED, 1xG9, max 10W only LED

fabric, painted steel, solid brass, flexible stem

8213

1xE27, max 10W only LED, 1xG9, max 10W only LED

CHILLIN

fabric, painted steel

8201 8197

1xE27, max 10W only LED



LUSO 11521

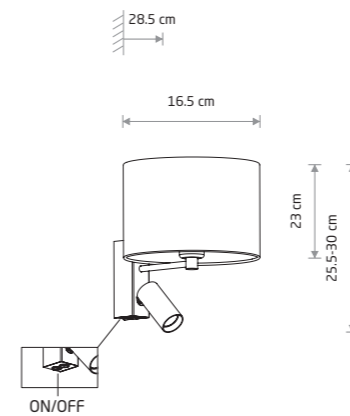

LUSO

fabric, painted steel

11520 11521

1xE27, 1x GU10 R35 max 10W only LED



DROPS WOOD C
11175



DROPS WOOD C
plywood, painted steel

■ 11175

● 1xE27, max 25W only LED

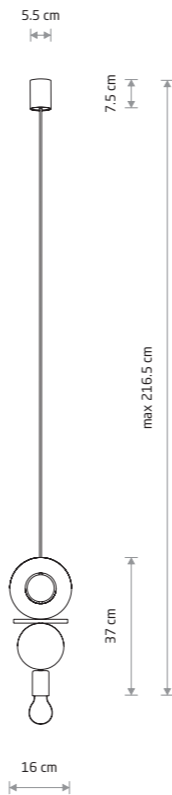

DROPS WOOD E
plywood, painted steel

■ 11177

● 1xE27, max 25W only LED



DROPS WOOD E
11177

DROPS WOOD D
plywood, painted steel

■ 11176

● 1xE27, max 25W only LED

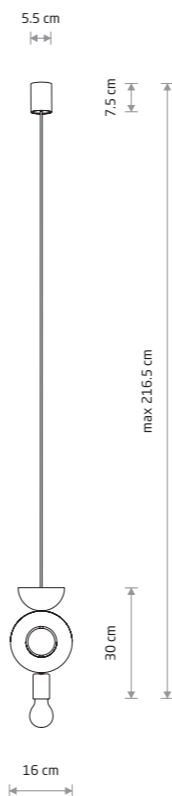
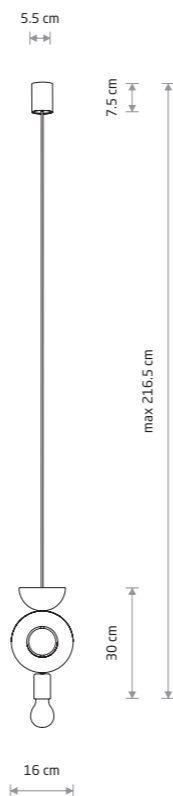

DROPS WOOD F
plywood, painted steel

■ 11180

● 1xE27, max 25W only LED



DROPS WOOD F
11180

DROPS WOOD A
11173



DROPS WOOD B
11174



DROPS WOOD A
plywood, glass, painted steel

11173

1xG9, max 12W only LED

BULB LED G9, 4W

7503 3000K 7504 4000K



DROPS WOOD B
plywood, glass, painted steel

11174

1xG9, max 12W only LED

BULB LED G9, 4W

7503 3000K 7504 4000K

DROPS WOOD A
11173



SUNSET B
7655

SUNSET C
7654



SUNSET C 7654

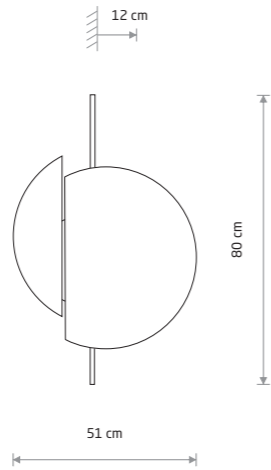

SUNSET C

plywood, painted steel

7654

2xGX53, max 12W only LED

SUNSET NATURAL B

plywood, painted steel

10577

2xGX53, max 12W only LED

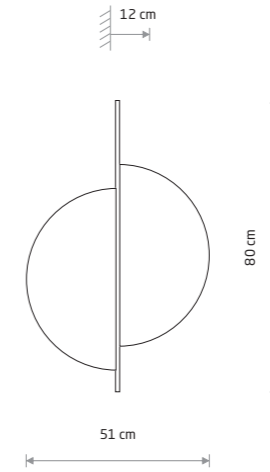

SUNSET NATURAL B 10577



SUNSET B 7655

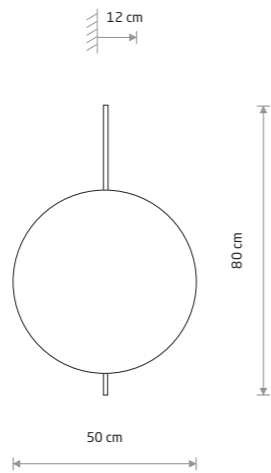

SUNSET B

plywood, painted steel

7655

2xGX53, max 12W only LED

SUNSET NATURAL C

plywood, painted steel

10578

2xGX53, max 12W only LED

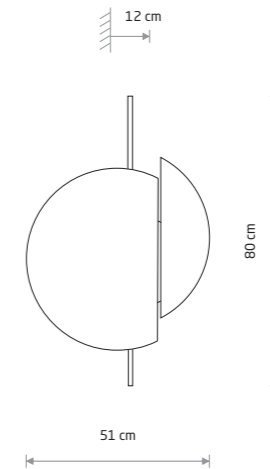

SUNSET NATURAL C 10578



SUNSET A 7653

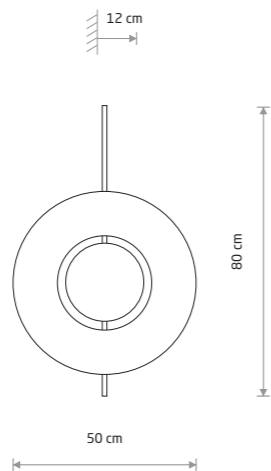

SUNSET A

plywood, painted steel

7653

2xGX53, max 12W only LED

SUNSET NATURAL A

plywood, painted steel

10576

2xGX53, max 12W only LED

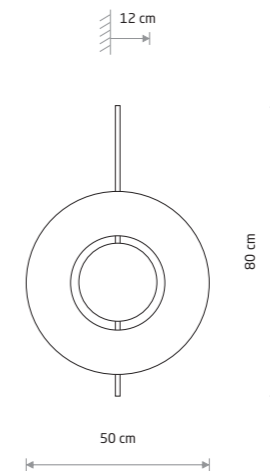

SUNSET NATURAL A 10576



SUNSET LED D
11432

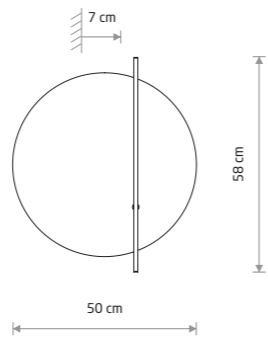

SUNSET LED D
plywood, painted aluminum, painted steel

11432



SUN LED 7651

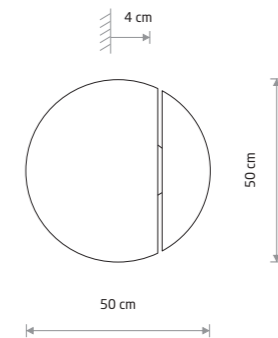

SUN LED
plywood, painted steel

7651



SUNRISE LED
7652

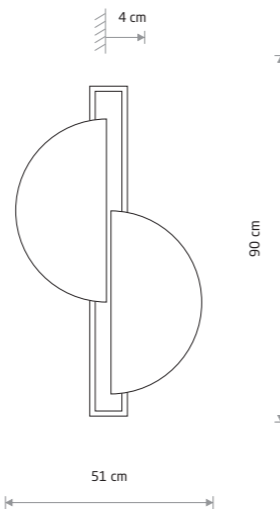

SUNRISE LED
plywood, painted steel

7652



SUNSET 7647

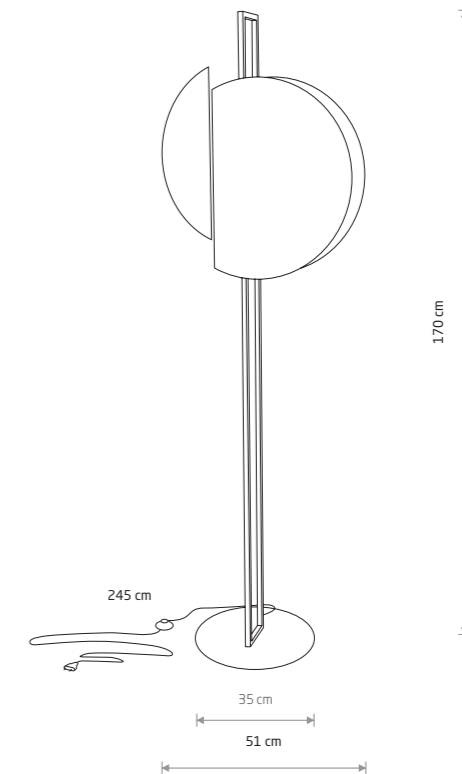

SUNSET
plywood, painted steel

7647

2xGX53, max 12W only LED

Item No.	Power	Colour temp.	Luminous flux	Colour Rendering Index (CRI)	Input	Safety type	Ingress protection	Lifetime
7652	14W LED	3000K	340 lm	>90	~220-230 V, 50/60 Hz	⊕	IP20	30000h
11432	7W LED	3000K	65 lm	>90	~220-230 V, 50/60 Hz	⊕	IP20	30000h

Item No.	Power	Colour temp.	Luminous flux	Colour Rendering Index (CRI)	Input	Safety type	Ingress protection	Lifetime
7651	15W LED	3000K	610 lm	>90	~220-230 V, 50/60 Hz	⊕	IP20	30000h



RING TIMBER LED M
11290

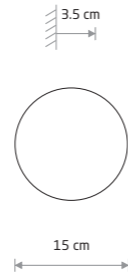

RING TIMBER LED S

plywood, painted steel

11288

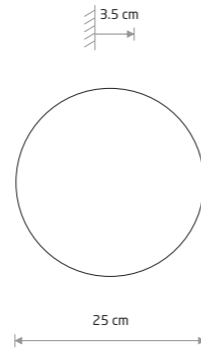

RING TIMBER LED M

plywood, painted steel

11290

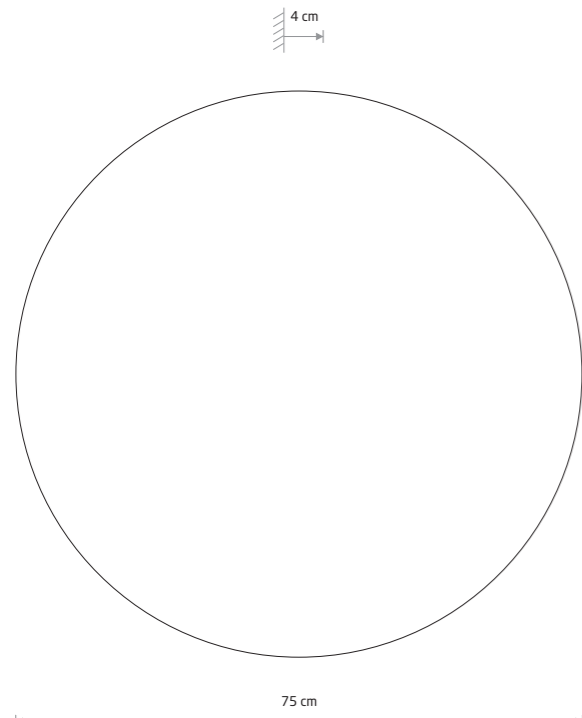

RING TIMBER LED XXL

plywood, painted aluminum, painted steel

11178

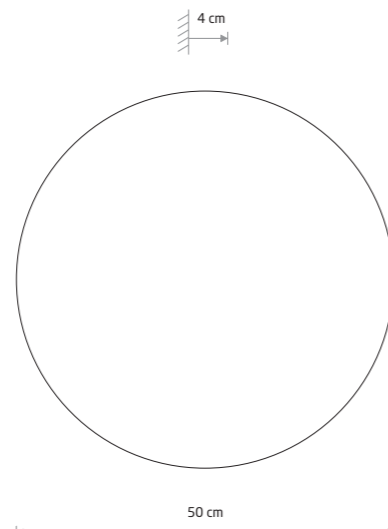

RING TIMBER LED XL

plywood, painted aluminum, painted steel

11292

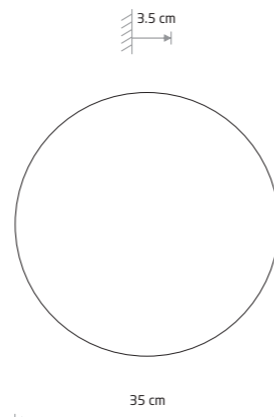

RING TIMBER LED L

plywood, painted steel

11291



RING TIMBER LED XXL 11178

Item No.	Power	Colour temp.	Luminous flux	Colour Rendering Index (CRI)	Input	Safety type	Power factor	Ingress protection	Lifetime
11288	7W LED	3000K	60 lm	>90	~220-230 V, 50/60 Hz	⊕	>0.5	IP20	30000h
11290	10W LED	3000K	130 lm	>90	~220-230 V, 50/60 Hz	⊕	>0.5	IP20	30000h
11291	13W LED	3000K	160 lm	>90	~220-230 V, 50/60 Hz	⊕	>0.5	IP20	30000h
11292	16W LED	3000K	290 lm	>90	~220-230 V, 50/60 Hz	⊕	>0.5	IP20	30000h
11178	22W LED	3000K	400 lm	>90	~220-230 V, 50/60 Hz	⊕	>0.5	IP20	30000h

DARK WOOD



WHEEL 9028

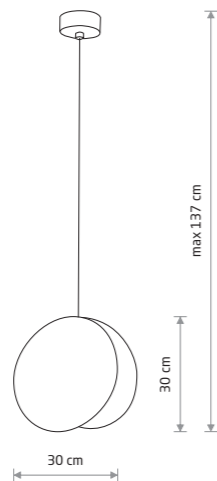

WHEEL

plywood, painted steel

9028 9033

1xE27, max 10W only LED

WHEEL LUX 8430

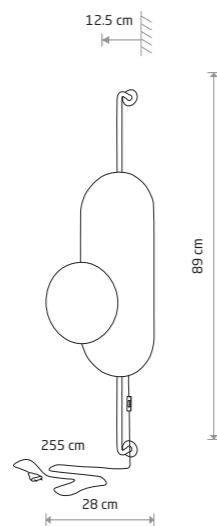

WHEEL LUX

plywood, painted steel

8430

1xG9, max 10W only LED

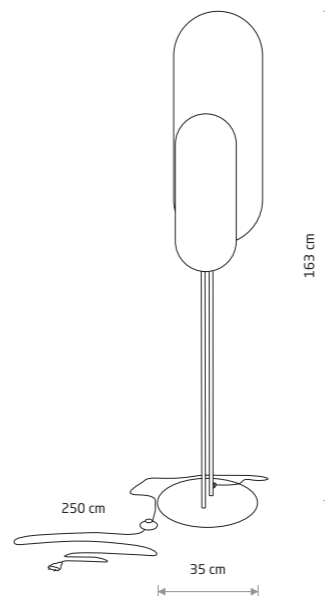

WHEEL LUX

plywood, painted steel

7646

2xGX53, max 12W only LED



WHEEL LUX 7646



RING WOOD LED M
10281

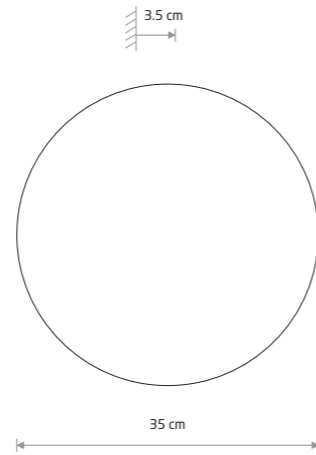

RING WOOD LED L

plywood, painted steel

10282

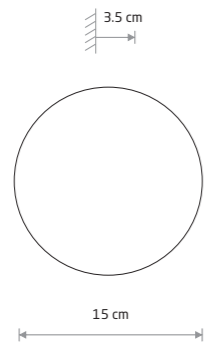

RING WOOD LED S

plywood, painted steel

10280

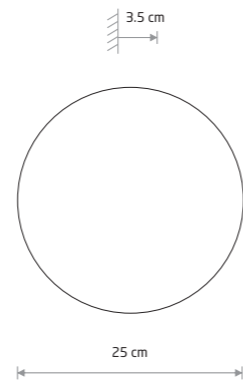

RING WOOD LED M

plywood, painted steel

10281



RING WOOD LED M
10281

RING WOOD LED S
10280



Item No.	Power	Colour temp.	Luminous flux	Colour Rendering Index (CRI)	Input	Safety type	Power factor	Ingress protection	Lifetime
10280	7W LED	3000K	60 lm	>90	~220-230 V, 50/60 Hz	⊕	>0.5	IP20	30000h
10281	10W LED	3000K	130 lm	>90	~220-230 V, 50/60 Hz	⊕	>0.5	IP20	30000h
10282	13W LED	3000K	160 lm	>90	~220-230 V, 50/60 Hz	⊕	>0.5	IP20	30000h

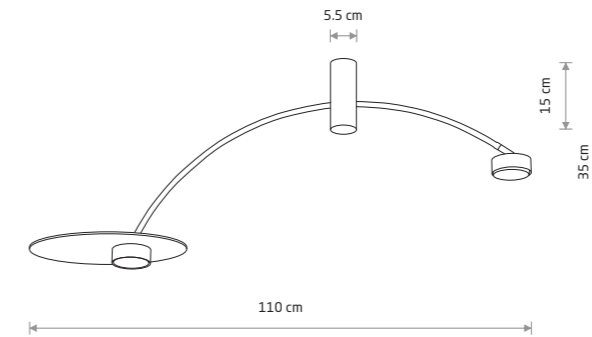
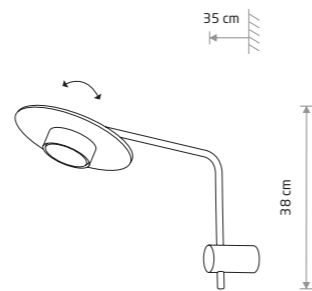
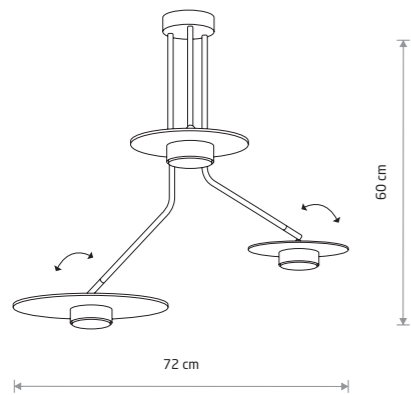

DISK
painted steel, plywood

7644

3xGX53, max 12W only LED

DISK
painted steel, plywood

7645

1xGX53, max 12W only LED

HEFT
painted steel, plywood

10356

2xGX53, max 12W only LED



KYMI B 10571

KYMI A 10570

THE
NORDIC
BAKING
BOOK

KYMI A 10573

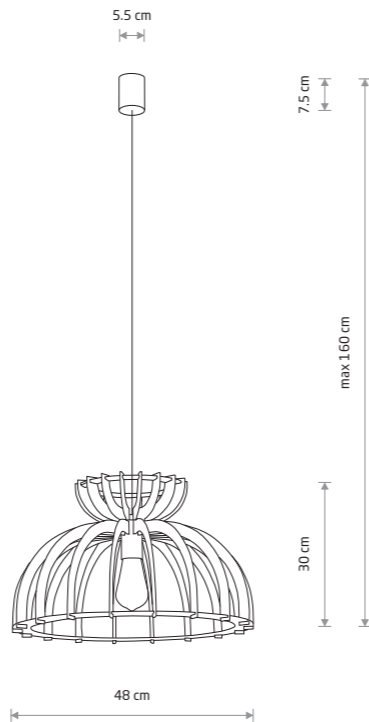

KYMI C
plywood, painted steel, braided cable
10572 ■ 10575
1x E27, max 25W only LED

IKA A 4171



IKA D 4174

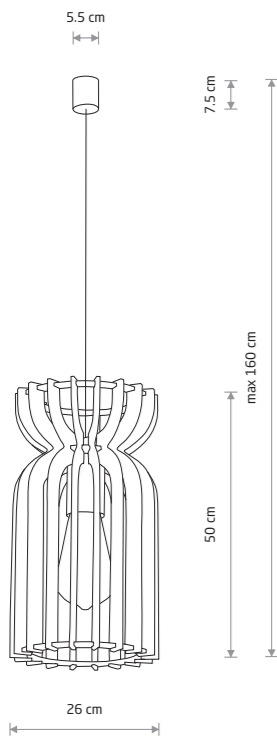

KYMI A
plywood, painted steel, braided cable
10570 ■ 10573
1x E27, max 25W only LED



KYMI B 10571

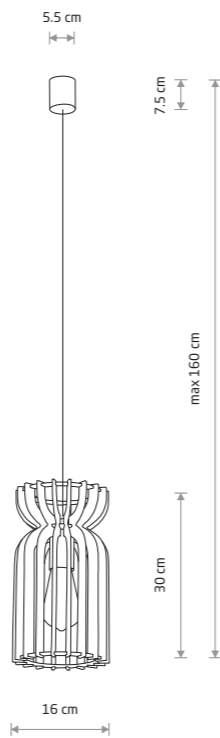

KYMI B
plywood, painted steel, braided cable
10571 ■ 10574
1x E27, max 25W only LED

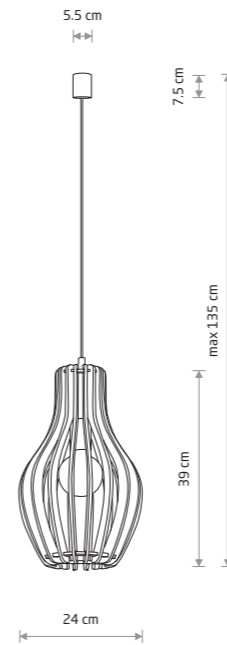

IKA A
plywood, painted steel
4171
1x E27, max 25W only LED

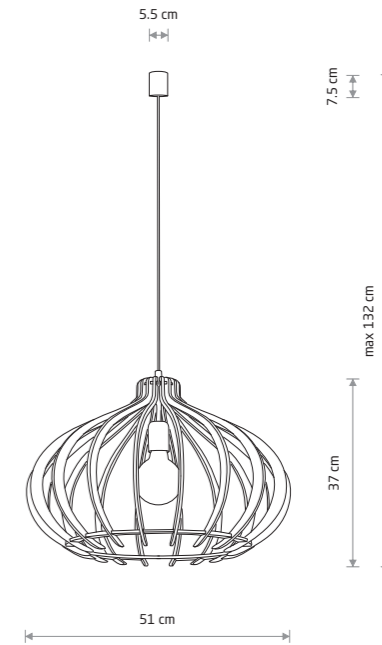

IKA D
plywood, painted steel
4174
1x E27, max 25W only LED



DOVER 9263





DOVER 9263

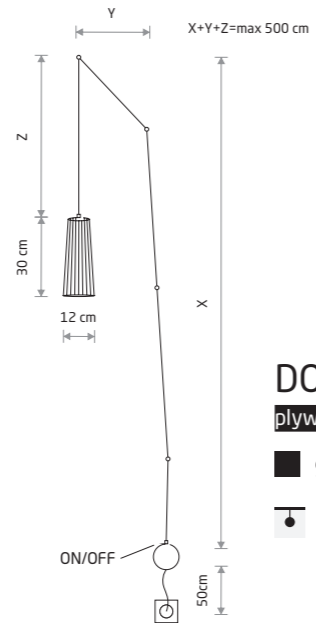

DOVER

plywood, braided cable, painted steel

■ 9264

● 1xGU10 R50, max 10W only LED

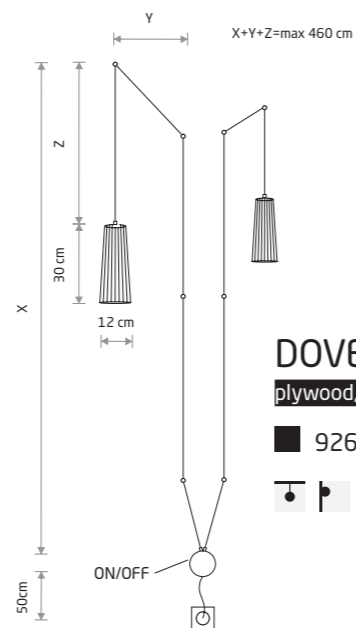

DOVER

plywood, braided cable, painted steel

■ 9263

● 2xGU10 R50, max 10W only LED

DOVER 9261



DOVER 9266

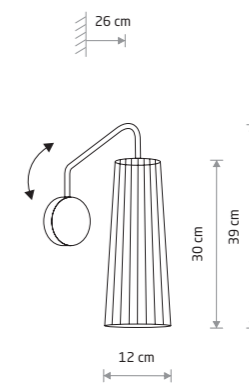

DOVER

plywood, painted steel

■ 9261 ■ 9266

● 1xGU10 R50, max 10W only LED

MINIMAL 9377

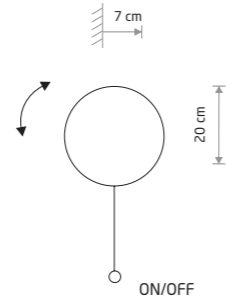

MINIMAL

wood, painted steel

9377

1xG9, max 10W only LED

OSLO 30 9700

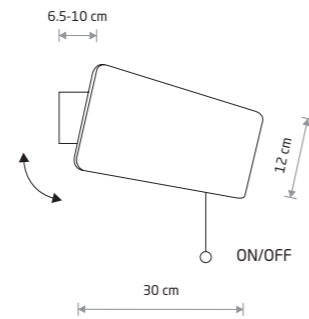

OSLO 30

wood, painted steel

9700

1xE14, max 15W only LED



OSLO LED 7522

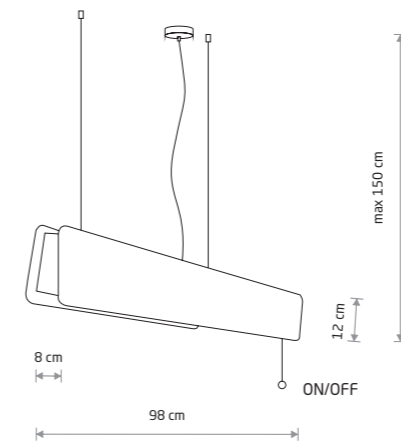

OSLO LED 90

wood, painted steel

7522 7520

1xLED TUBE T8, max 16W, included

Name	Size	Power	Colour temp.	Luminous flux	Beam angle	Colour Rendering Index (CRI)	Input	Power factor	LED driver	Lifetime	Material
LED TUBE T8	90 cm	16W LED	3000K	2300 lm	120 °	≥80	~220-230 V, 50/60 Hz	>0,5	INCL	30000h	CLEAR GLASS



RATTAN M
11154



RATTAN S
11153



PUKET M
11161

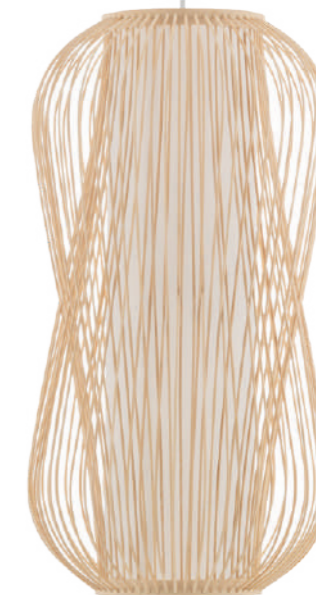

PUKET L
11162

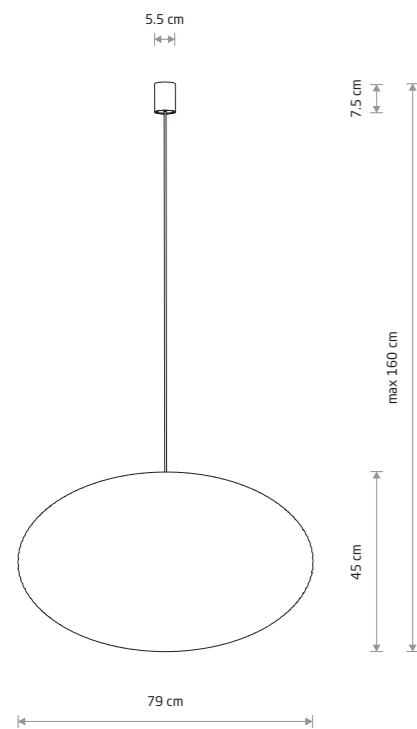

RATTAN L
rattan, painted steel

11155

1xE27, max 25W only LED

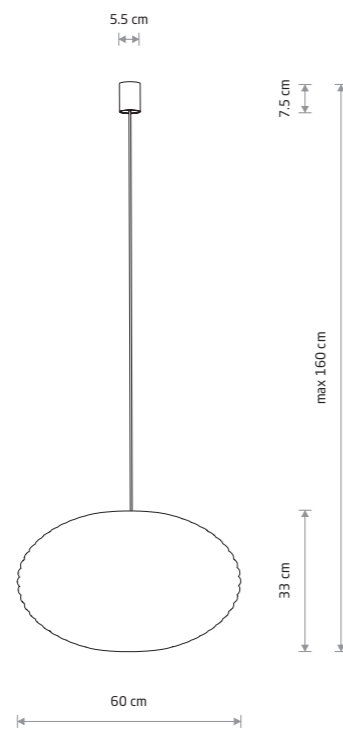

RATTAN M
rattan, painted steel

11154

1xE27, max 25W only LED

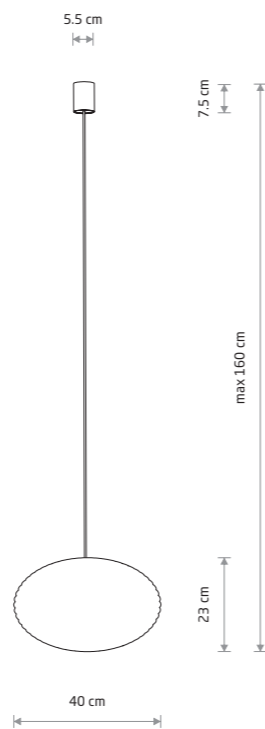

RATTAN S
rattan, painted steel

11153

1xE27, max 25W only LED

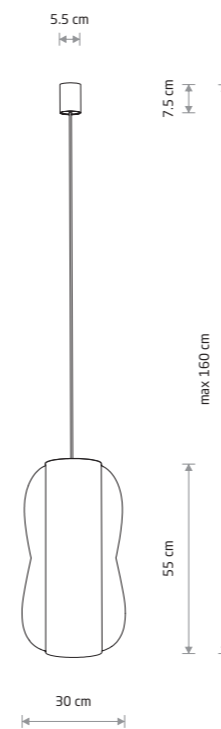

PUKET L
bamboo, painted steel

11162

1xE27, max 25W only LED

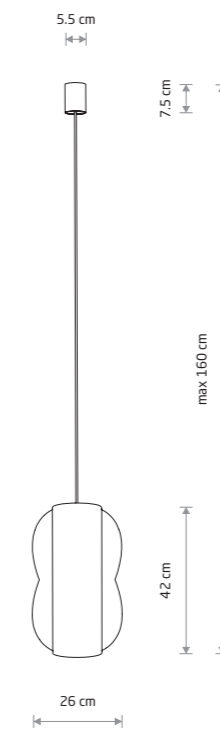

PUKET M
bamboo, painted steel

11161

1xE27, max 25W only LED

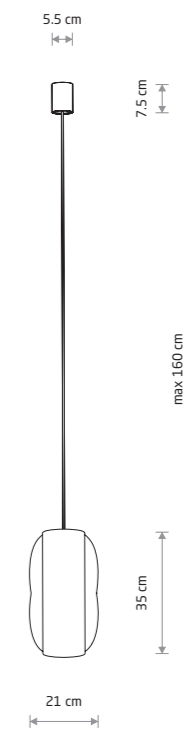

PUKET S
bamboo, painted steel

11160

1xE27, max 25W only LED



HAVANA S 11170

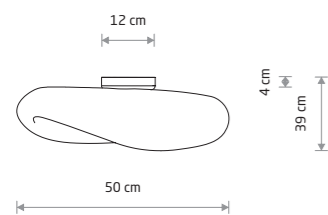

HAVANA S
bamboo, painted steel, plastic ABS

■ 11170

☐ 1xE27, max 25W only LED

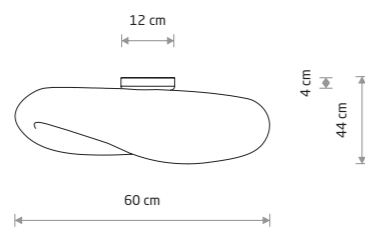

HAVANA M
bamboo, painted steel, plastic ABS

■ 11171

☐ 1xE27, max 25W only LED

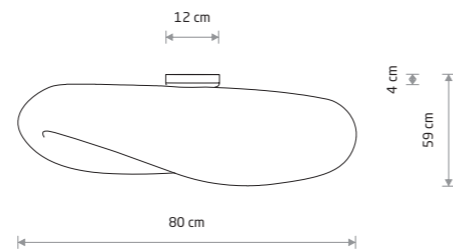

HAVANA L
bamboo, painted steel, plastic ABS

■ 11172

☐ 1xE27, max 25W only LED

■ NATURAL WOOD ☐ WHITE P003 RAL 9003



HAVANA M
11396

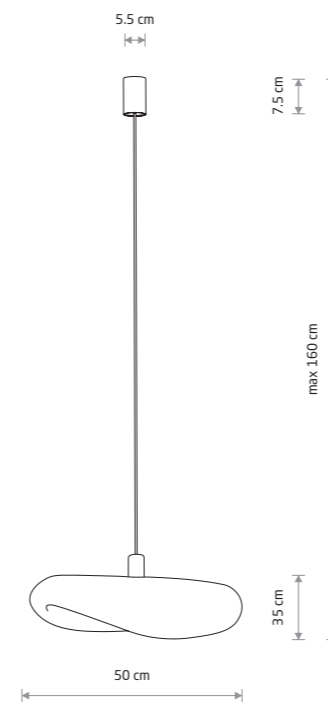

HAVANA S
bamboo, painted steel

■ 11395

☐ 1xE27, max 25W only LED

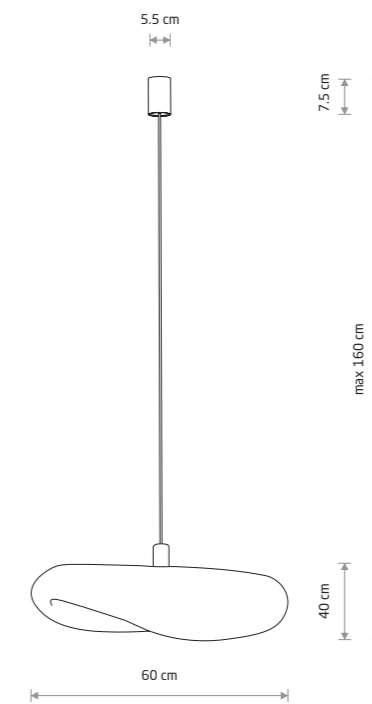

HAVANA M
bamboo, painted steel

■ 11396

☐ 1xE27, max 25W only LED

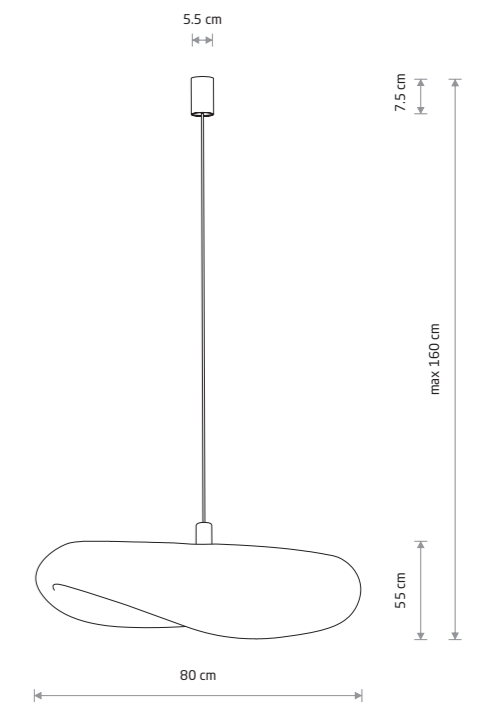

HAVANA L
bamboo, painted steel

■ 11397

☐ 1xE27, max 25W only LED

■ NATURAL WOOD ☐ WHITE P004 RAL 9003



HAITI S
11166



HAITI L
11168



BOHO S
11150

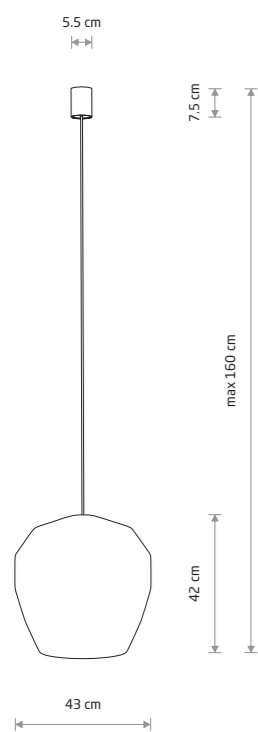

HAITI S
bamboo, painted steel

■ 11163 ■ 11166

● ● 1xE27, max 25W only LED

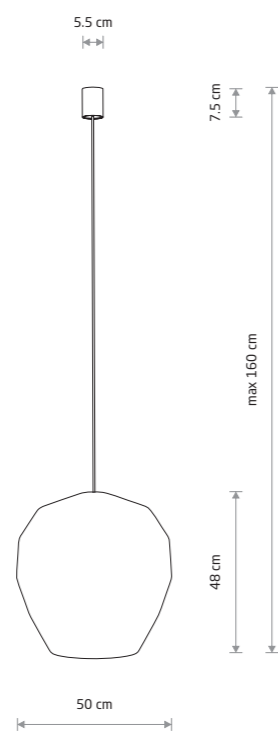

HAITI M
bamboo, painted steel

■ 11164 ■ 11167

● ● 1xE27, max 25W only LED

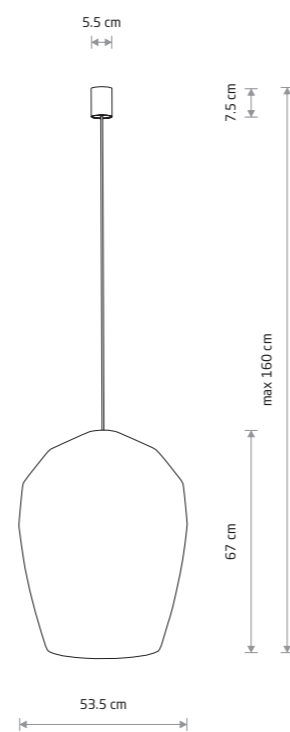

HAITI L
bamboo, painted steel

■ 11165 ■ 11168

● ● 1xE27, max 25W only LED



BOHO S
rattan, painted steel

■ 11150

● ● 1xE27, max 25W only LED

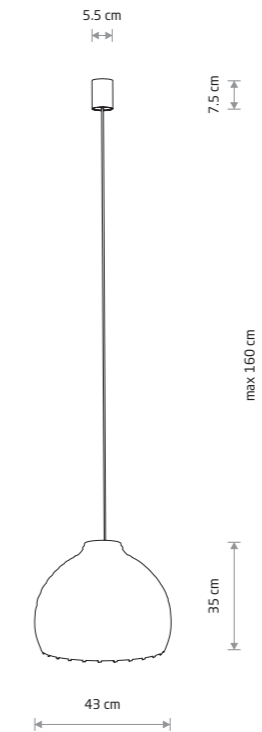

BOHO M
rattan, painted steel

■ 11151

● ● 1xE27, max 25W only LED

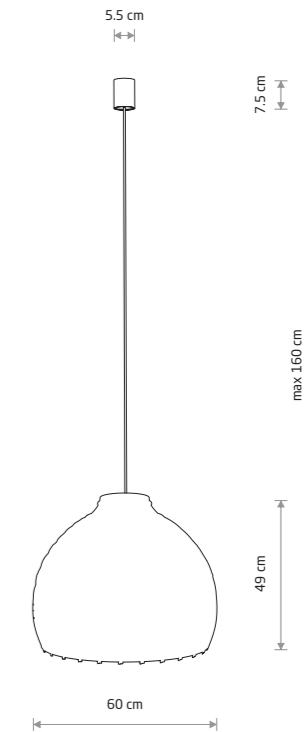

BOHO L
rattan, painted steel

■ 11152

● ● 1xE27, max 25W only LED

JAPANDI S
11156

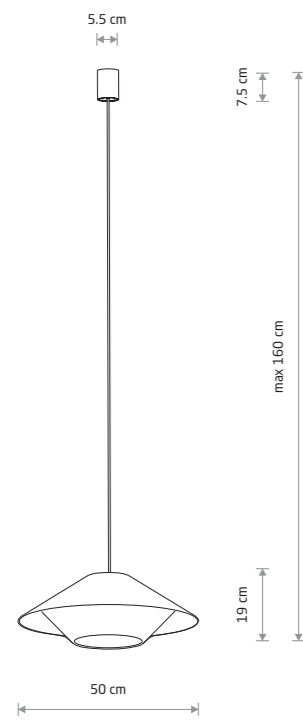

JAPANDI S
paper rope, painted steel

11156

1xE27, max 25W only LED

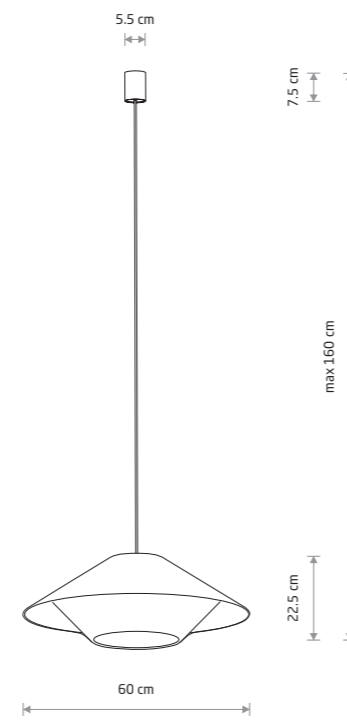

JAPANDI M
paper rope, painted steel

11157

1xE27, max 25W only LED

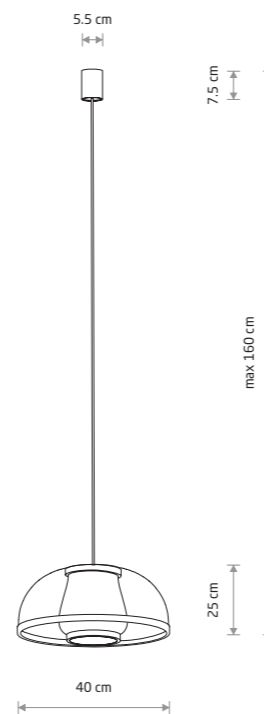

KRABI
bamboo, painted steel

11158

1xE27, max 25W only LED

KRABI 11158



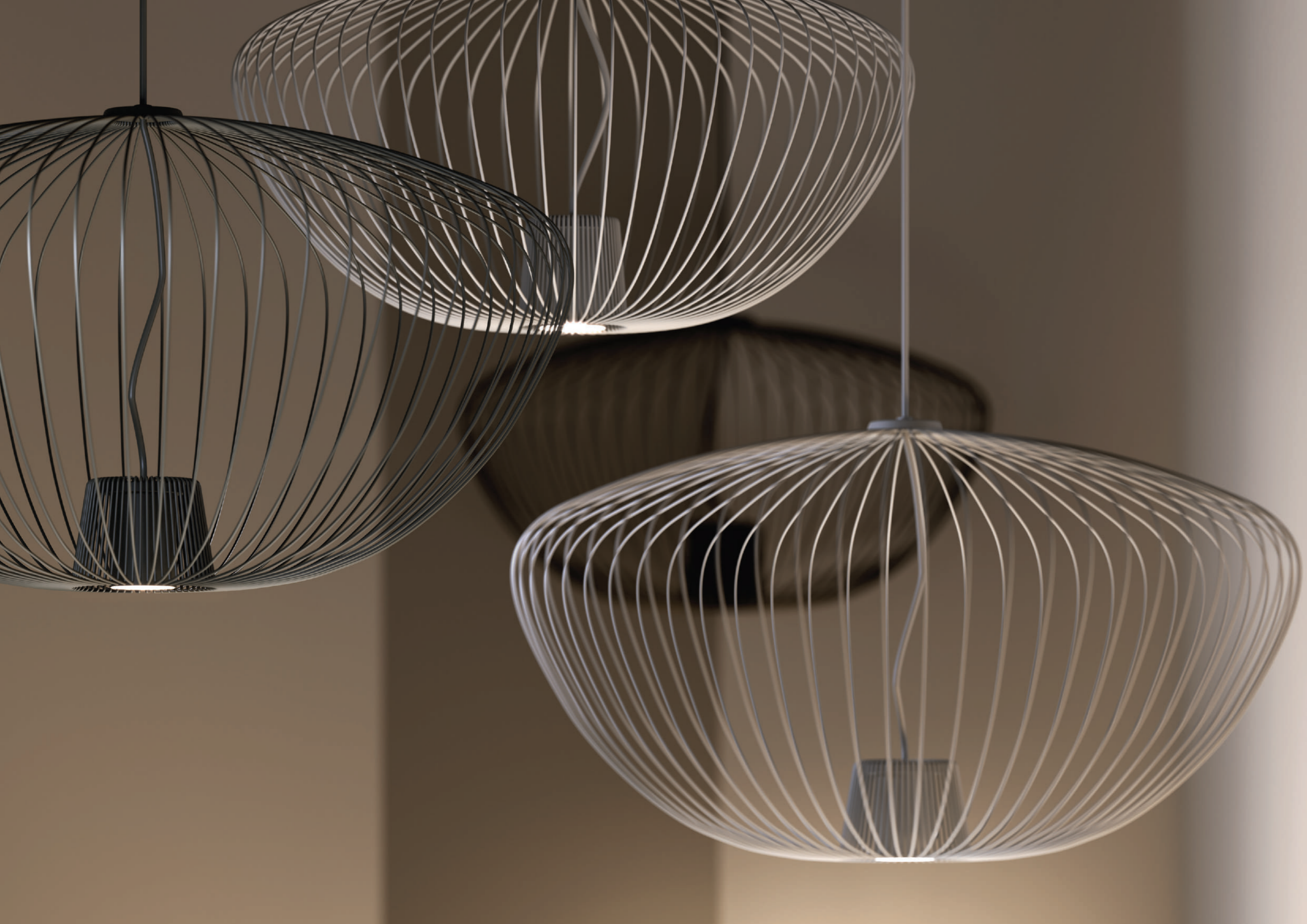

PUMPKIN S
11496

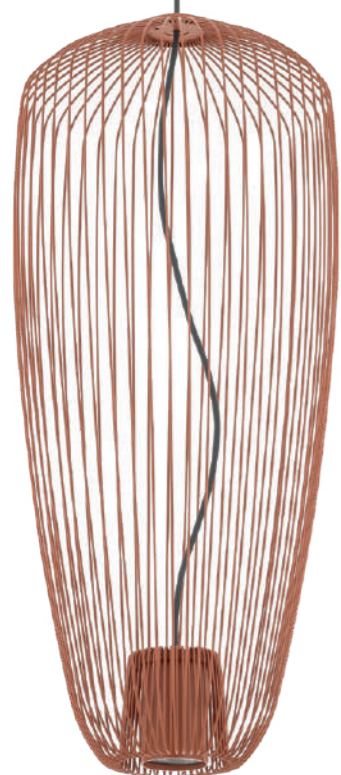

PUMPKIN S
11242



PUMPKIN L
11252

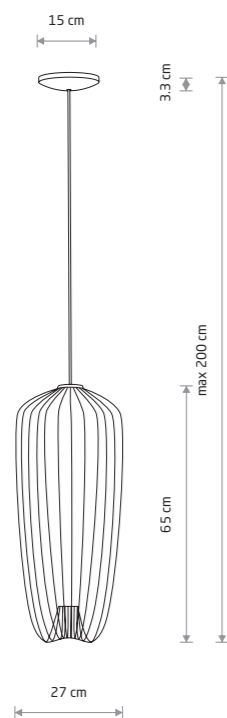

PUMPKIN S

painting steel

11242 11243 11496

1xGU10 R50, max 10W only LED

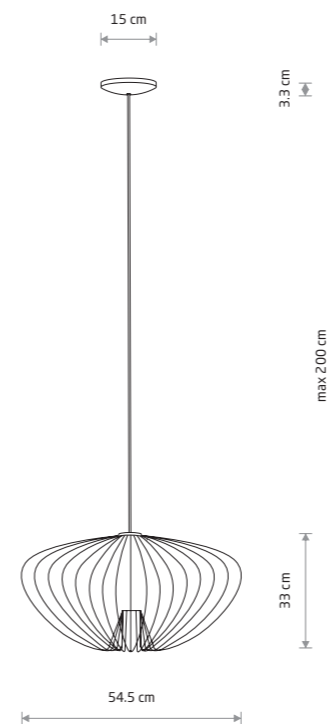

PUMPKIN M

painting steel

11244 11245 11495

1xGU10 R50, max 10W only LED

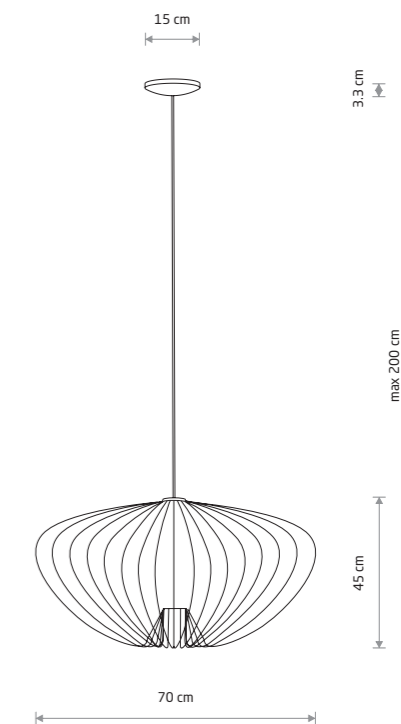

PUMPKIN L

painting steel

11251 11252 11494

1xGU10 R50, max 10W only LED



WAVE S 8858

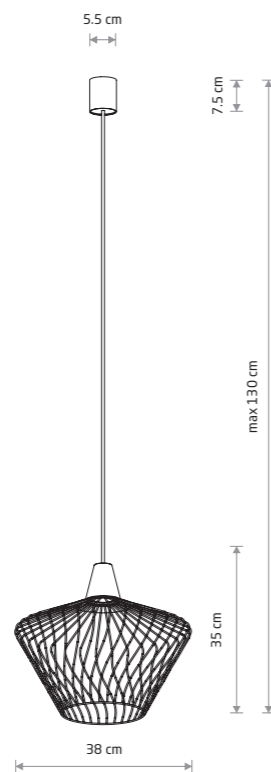

WAVE S

■ painted steel

■ 8858

● 1xE27, max 25W only LED

LUKSOR S

■ painted steel

■ 8851

● 1xE27, max 25W only LED

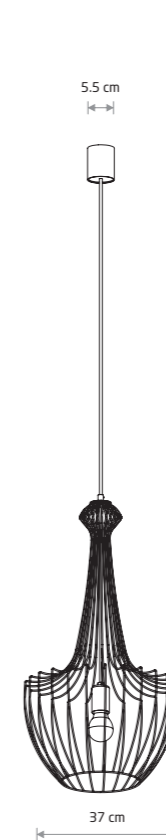

LUKSOR S 8851

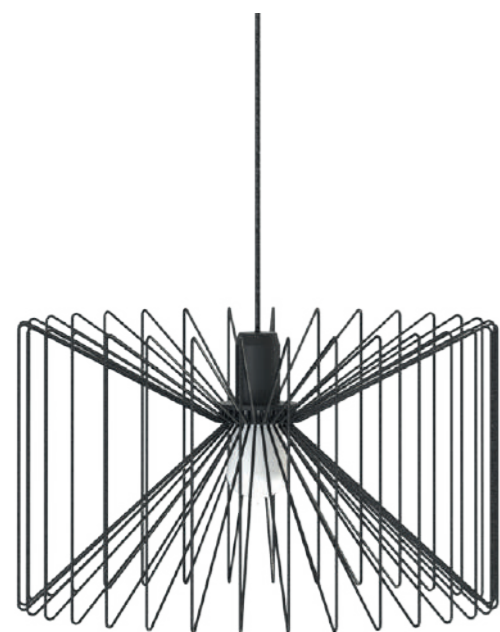

NESS 6768

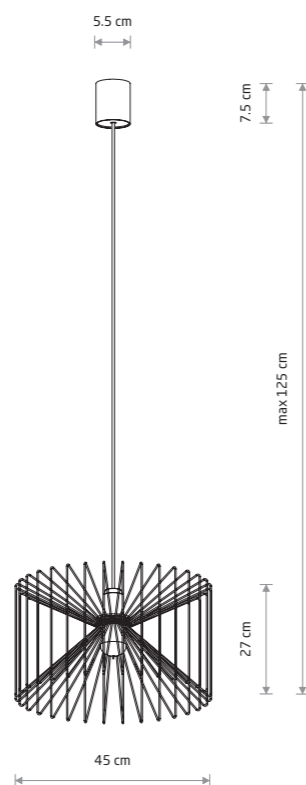

NESS

■ painted steel

■ 6768

● 1xE27, max 25W only LED

ABI L

■ painted steel, fabric

■ 8864

● 1xE27, max 25W only LED

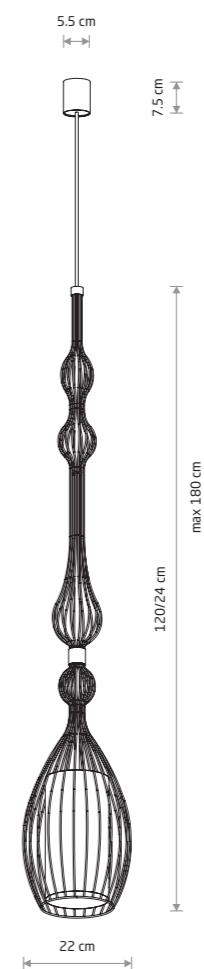

ABI L 8864



LUKSOR S 8851

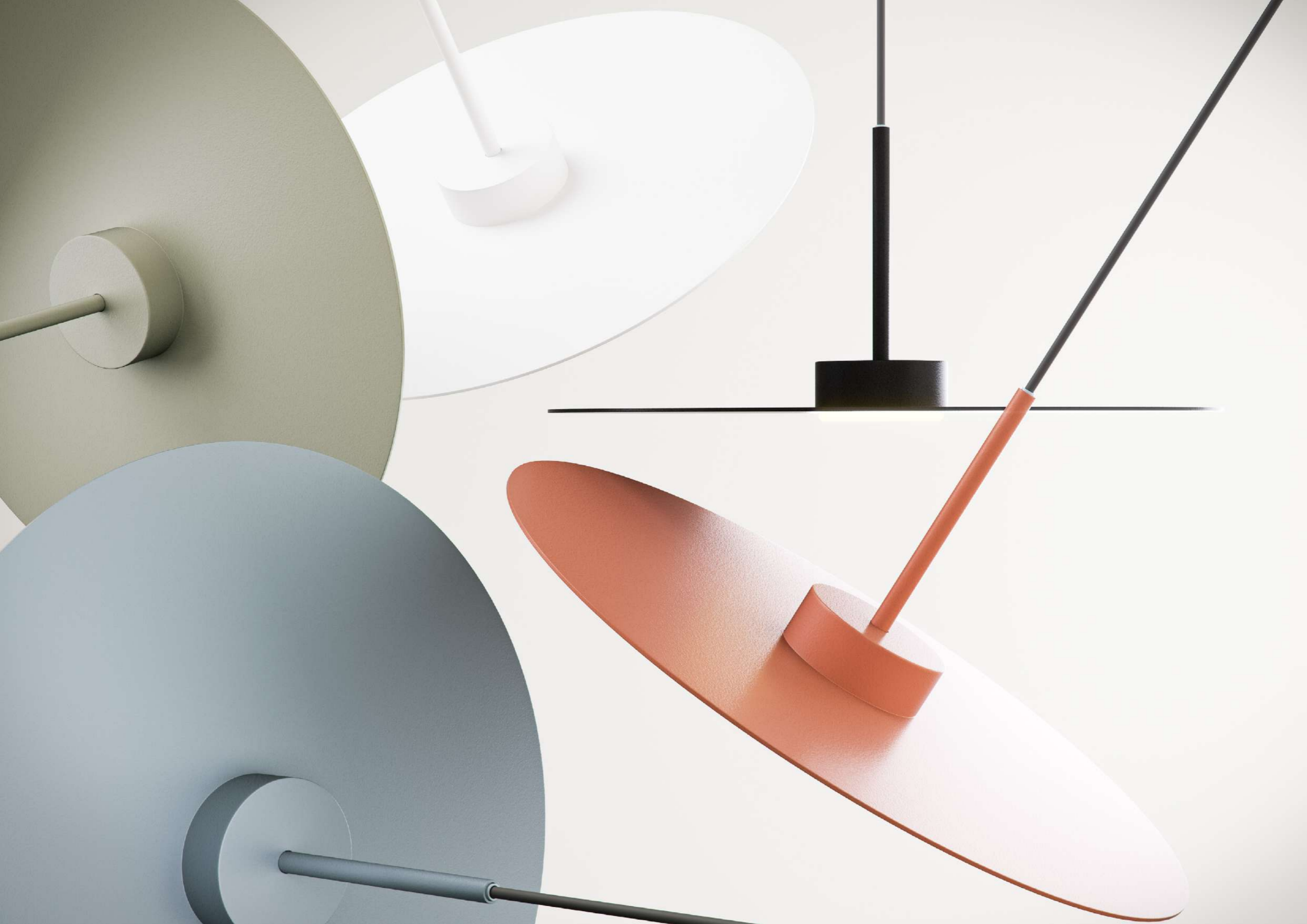



SIMONE
11412

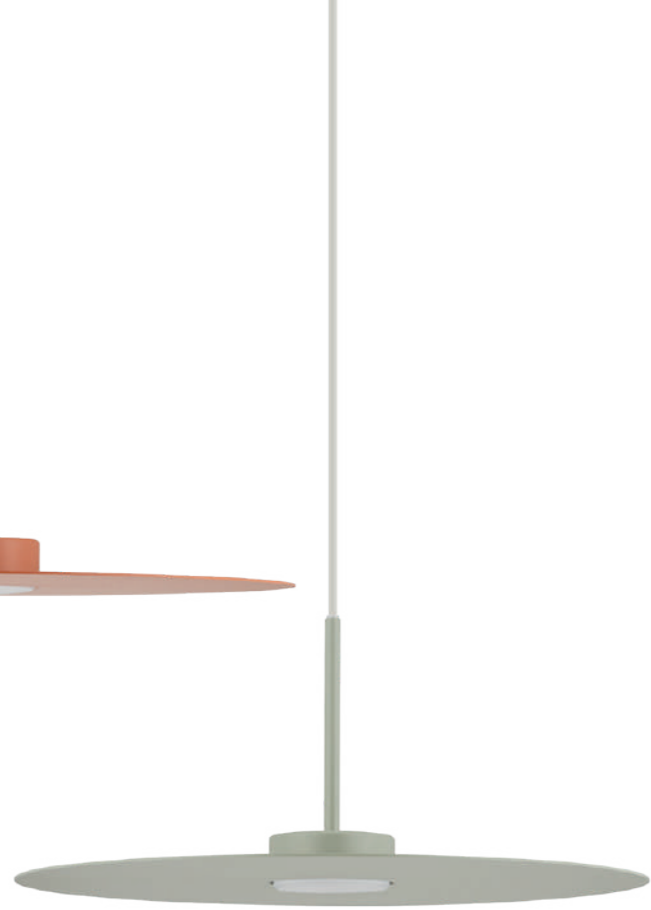

SIMONE
11413

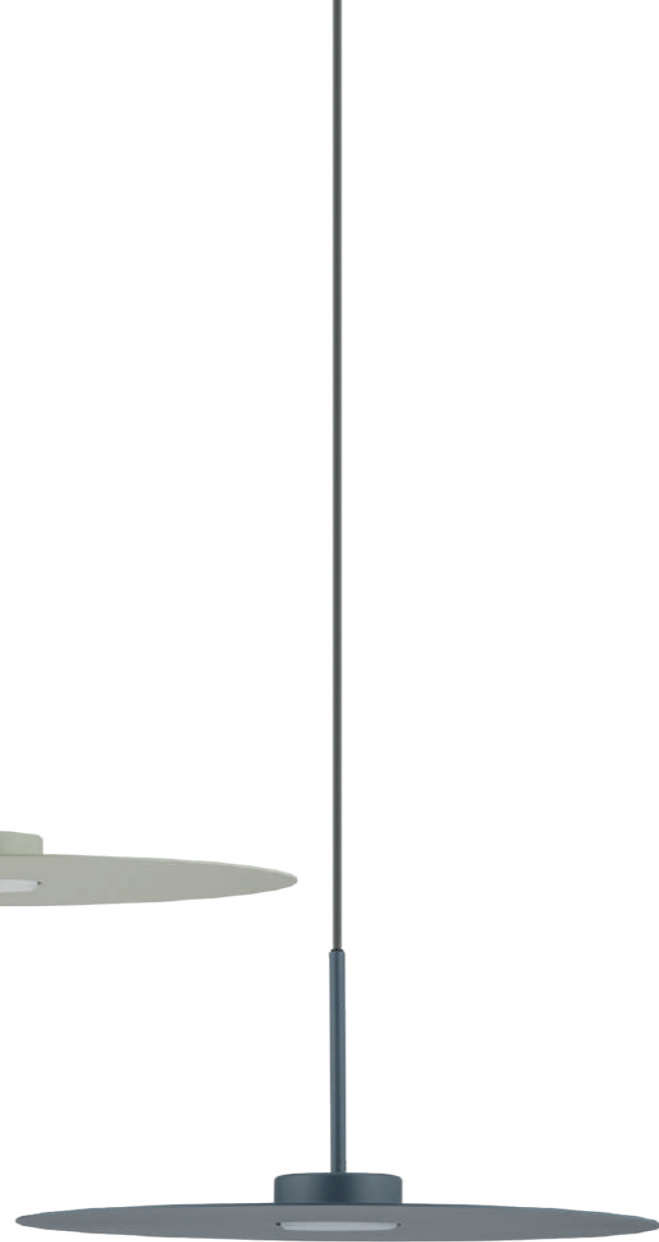

SIMONE
11414



SIMONE 11413

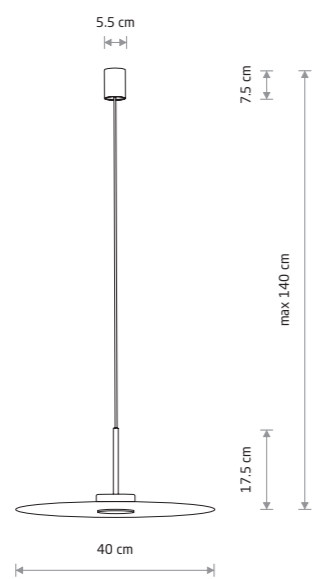

SIMONE
painted steel

■ 11410 ■ 11411 ■ 11412

■ 11413 ■ 11414

● 1xGX53, max 12W only LED



POINT DUO
11510



POINT DUO
11513



POINT DUO
11511



POINT DUO
11512

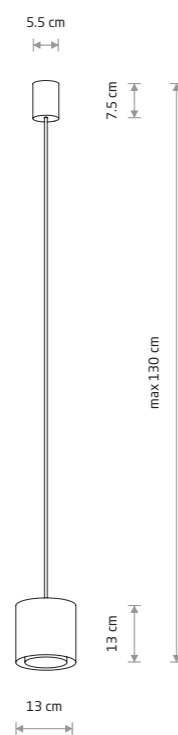

POINT DUO
painted steel, plastic ABS

- 11510 ■ 11511
- 11512 ■ 11513

● 1xGU10 R50, max 10W only LED





ZENITH XS
11456



ZENITH XS 11456



ZENITH M
11486

ZENITH L
11482

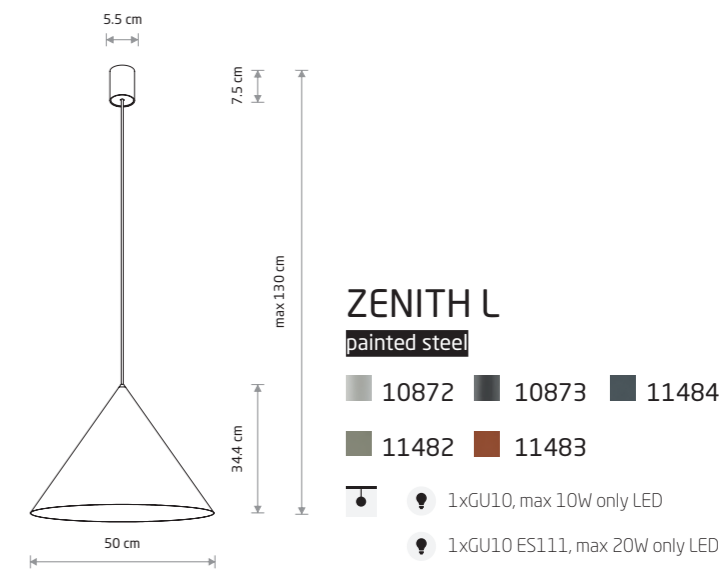
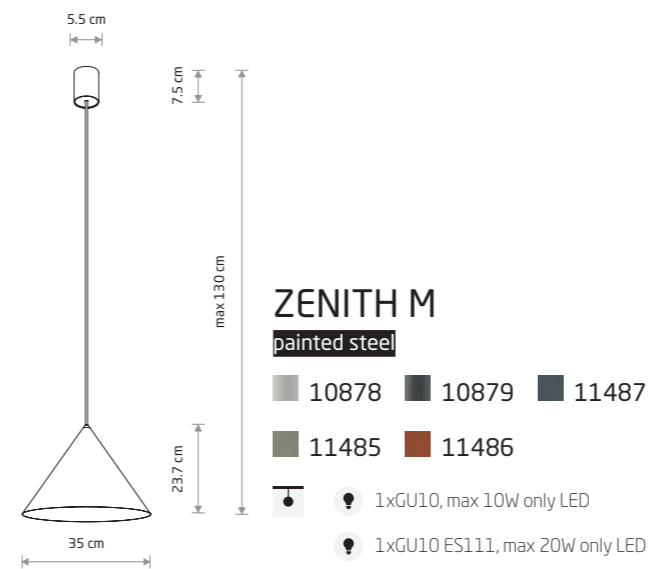
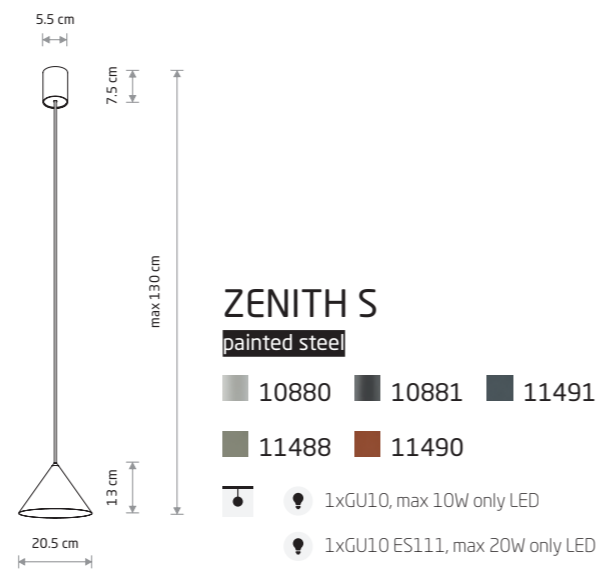
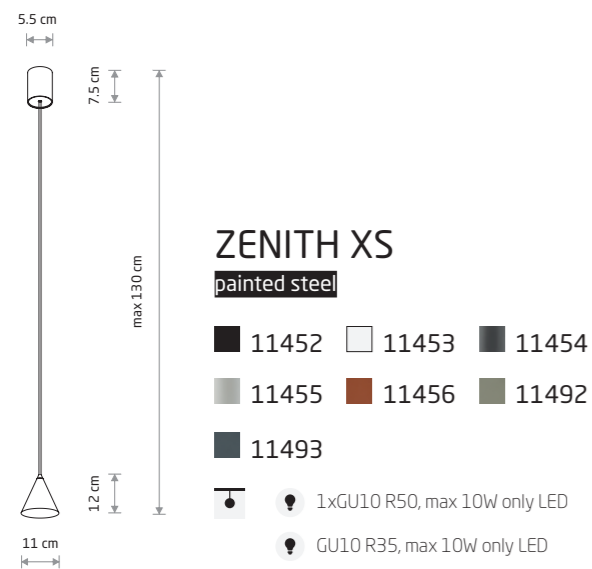

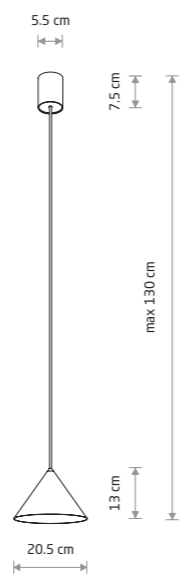
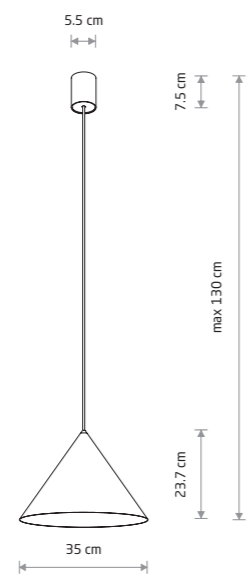
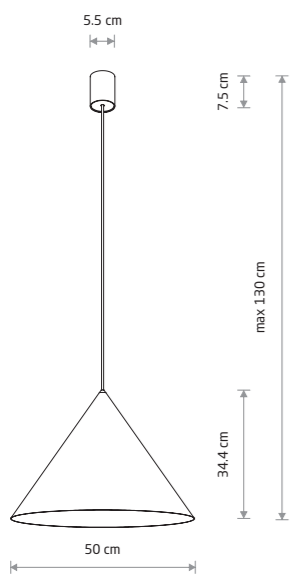

ZENITH L
painted steel, solid brass

- 8005 □ 8006 ■ 8007

- ⌚ 1xGU10, max 10W only LED
- ⌚ 1xGU10 ES111, max 20W only LED

ZENITH M
painted steel, solid brass

- 8001 □ 8002 ■ 8003

- ⌚ 1xGU10, max 10W only LED
- ⌚ 1xGU10 ES111, max 20W only LED

ZENITH S
painted steel, solid brass

- 7996 □ 7997 ■ 7998

- ⌚ 1xGU10, max 10W only LED
- ⌚ 1xGU10 ES111, max 20W only LED

■ BLACK P013 RAL 9005 □ WHITE P004 RAL 9003 ■ GREEN P022 ■ BRASS



SATELLITE M
11232



Visualisation by Iwona Ligęza

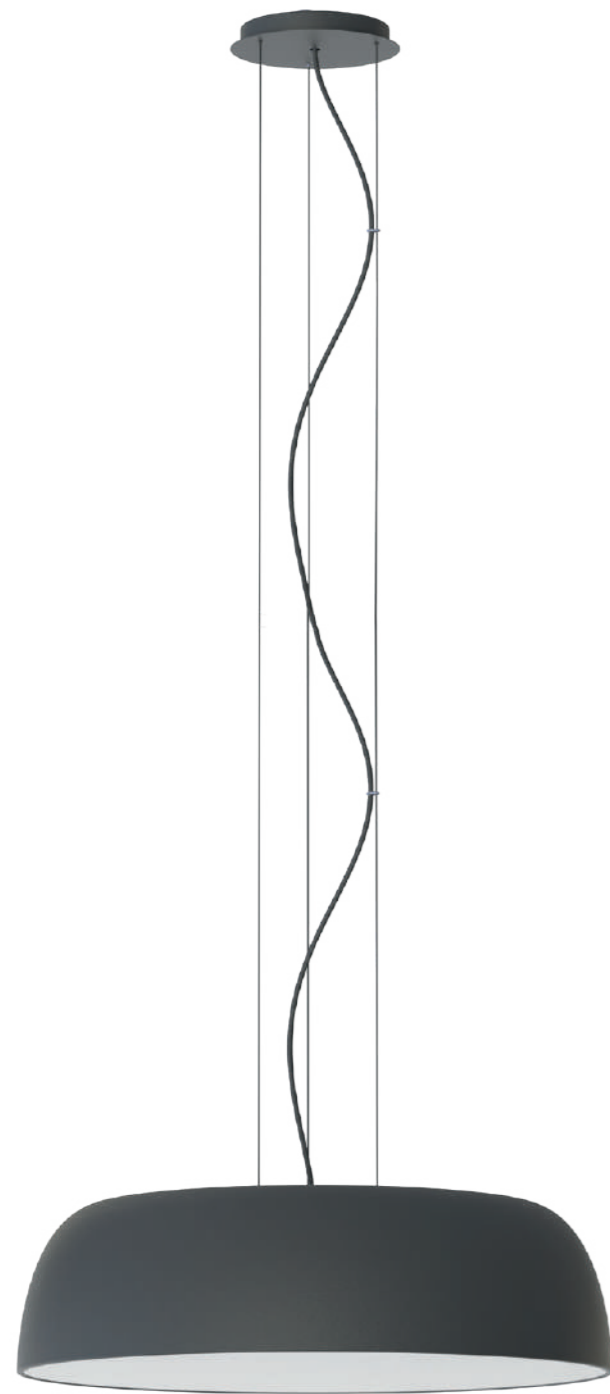

SATELLITE M
11232

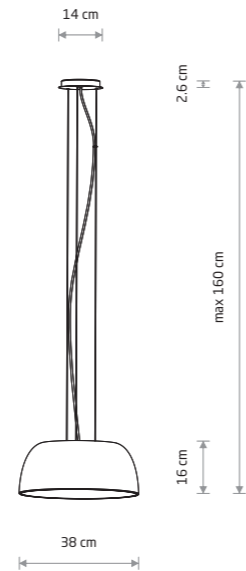

SATELLITE S

painting steel, plastic

11225 11228

11226 11227

3xE27, max 25W only LED

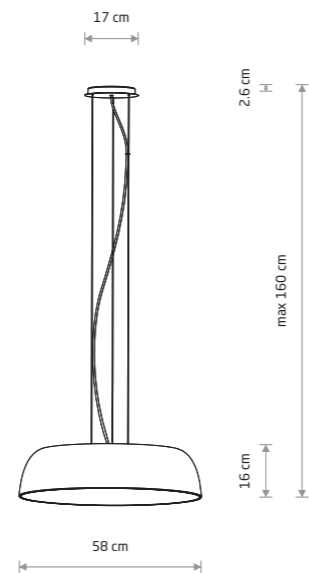

SATELLITE M

painting steel, plastic

11230 11233

11231 11232

7xE27, max 25W only LED



SATELLITE M 8018

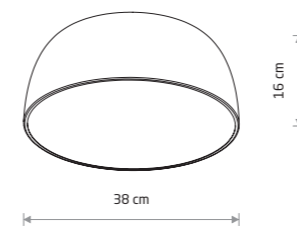

SATELLITE S

painting steel, plastic

8013 8012

8014 8015

3xE27, max 25W only LED

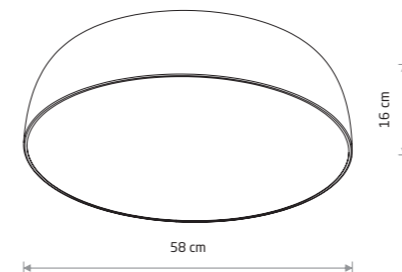

SATELLITE M

painting steel, plastic

8017 8016

8018 8020

7xE27, max 25W only LED



SATELLITE S SENSOR
8011

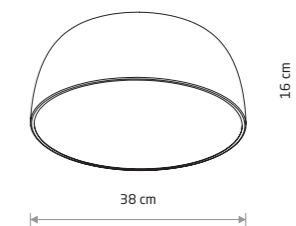

SATELLITE S SENSOR

painting steel, plastic

8011 8010

3xE27, max 25W only LED

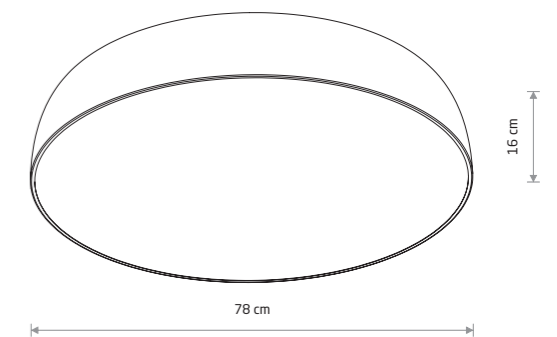

SATELLITE L

painting steel, plastic

8022 8021

8023 8024

10xE27, max 25W only LED



HERMANOS C 8192

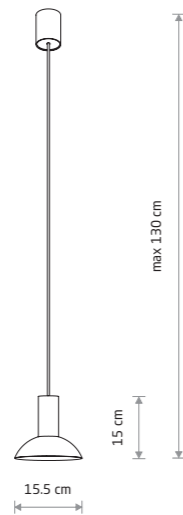

HERMANOS C

■ painted steel, solid brass

■ 8194

● 1xGU10 R50, max 10W only LED

■ painted steel

■ 8192

● 1xGU10 R50, max 10W only LED

HERMANOS

■ painted steel, solid brass

■ 8030

● 3xGU10 R50, max 10W only LED

■ painted steel

■ 10905

● 3xGU10 R50, max 10W only LED

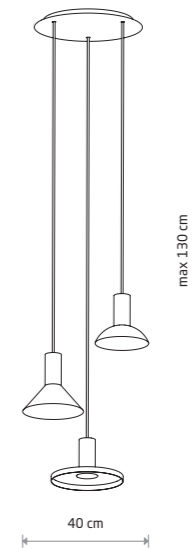

HERMANOS B 8102

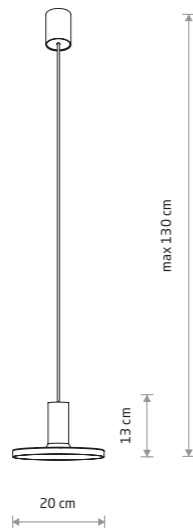

HERMANOS B

■ painted steel, solid brass

■ 8100

● 1xGU10 R50, max 10W only LED

■ painted steel

■ 8102

● 1xGU10 R50, max 10W only LED



HERMANOS 8032

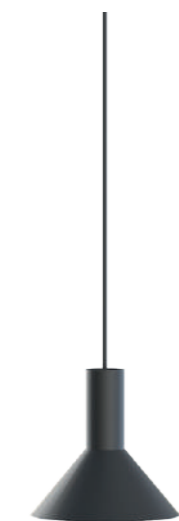

HERMANOS A 8105

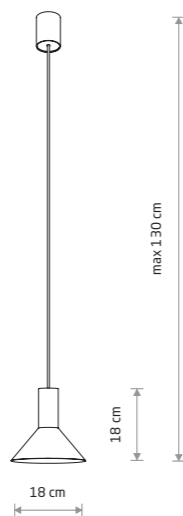

HERMANOS A

■ painted steel, solid brass

■ 8103

● 1xGU10 R50, max 10W only LED

■ painted steel

■ 8105

● 1xGU10 R50, max 10W only LED

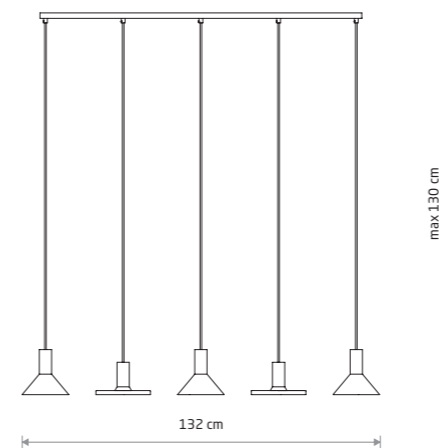

HERMANOS

■ painted steel, solid brass

■ 8032

● 5xGU10 R50, max 10W only LED

■ painted steel

■ 10906

● 5xGU10 R50, max 10W only LED



ORBIT 7805

ORBIT 7946



ORBIT 7946

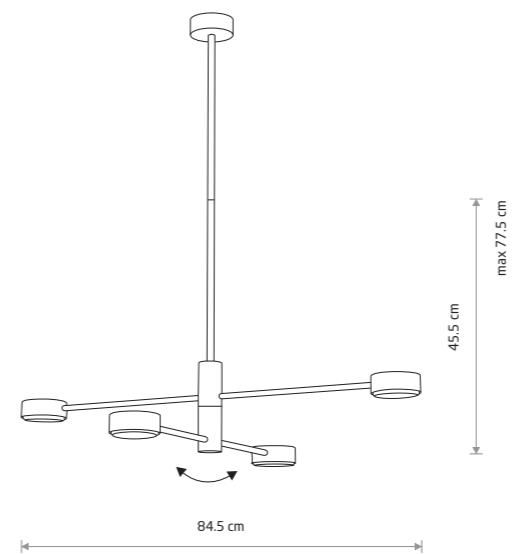

ORBIT

painted steel

□ 7941 ■ 7945

⚙️ 💡 4xGX53, max 12W only LED

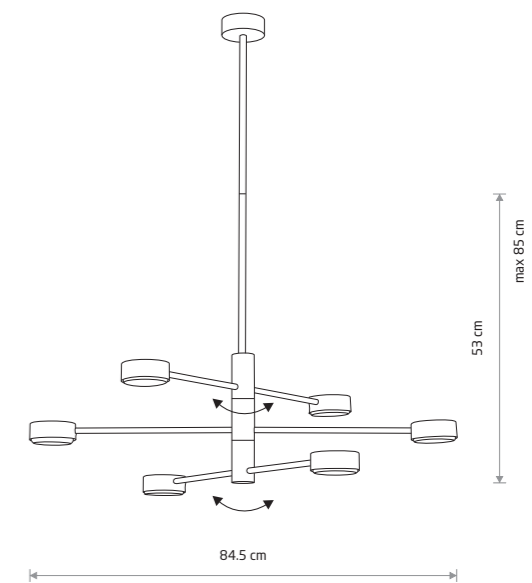

ORBIT

painted steel

□ 7942 ■ 7946

⚙️ 💡 6xGX53, max 12W only LED

ORBIT 7938

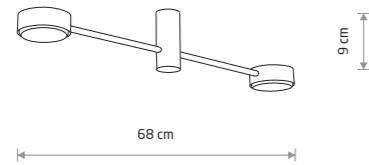

ORBIT

painting steel

□ 7938 ■ 7943

🔌 2xGX53, max 12W only LED

ORBIT 7805



ORBIT 7806

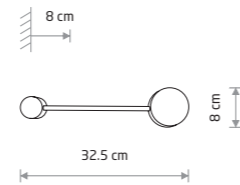
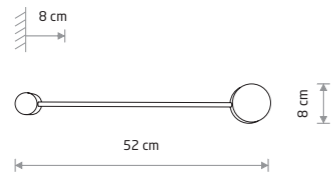

ORBIT

painting steel

□ 7802 ■ 7805

🔌 1xGX53, max 12W only LED

ORBIT

painting steel

□ 7803 ■ 7806

🔌 1xGX53, max 12W only LED

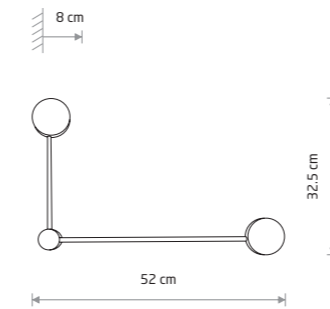

ORBIT

painting steel

□ 7801 ■ 7804

🔌 2xGX53, max 12W only LED

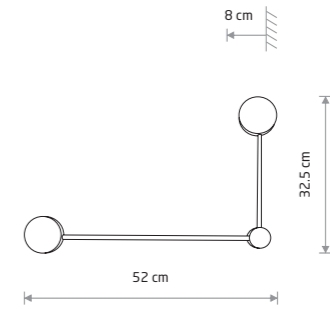

ORBIT

painting steel

□ 10637 ■ 10638

🔌 2xGX53, max 12W only LED

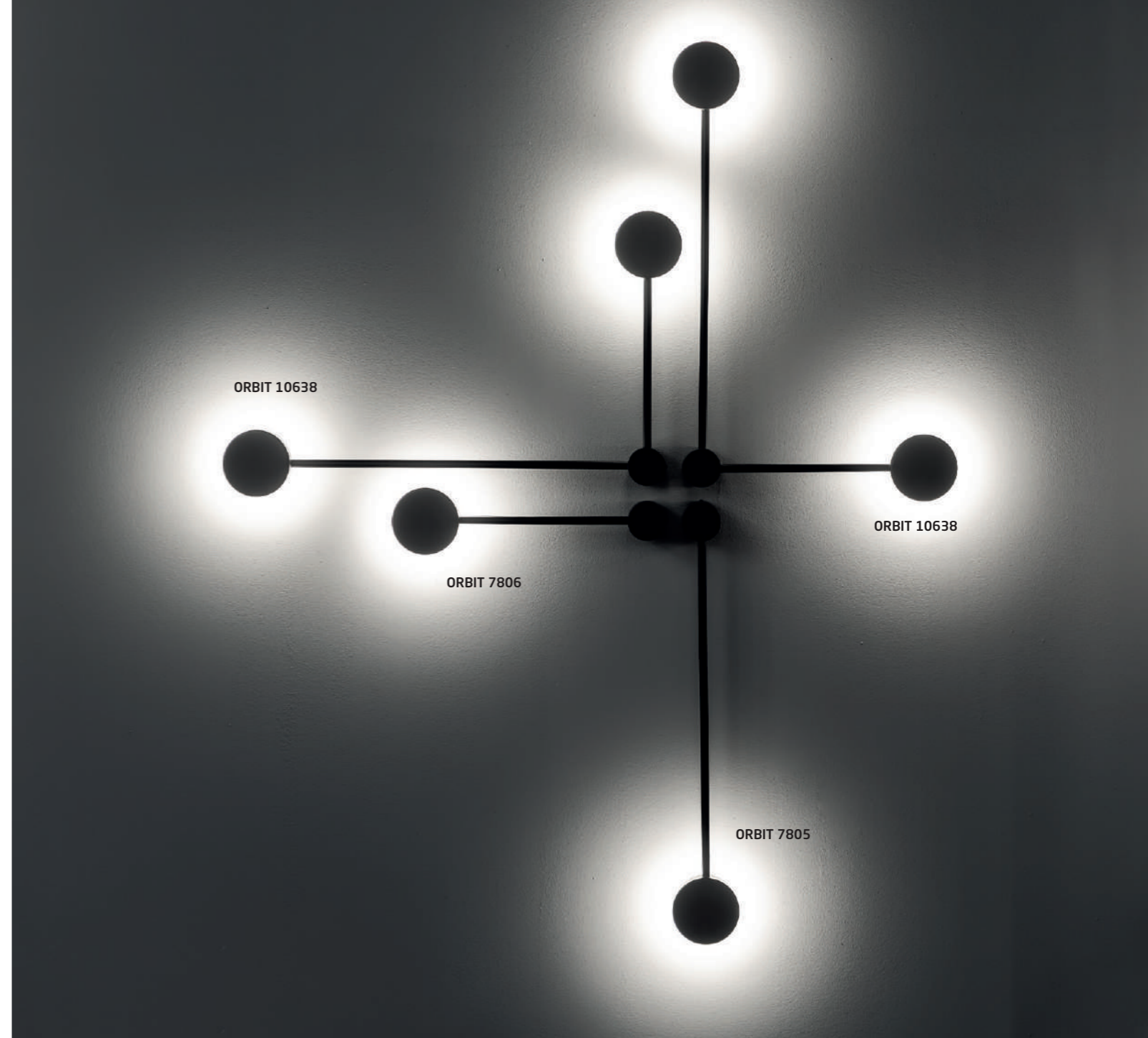

ORBIT 10638

ORBIT 10638

ORBIT 7806

ORBIT 7805



PILLS 8265

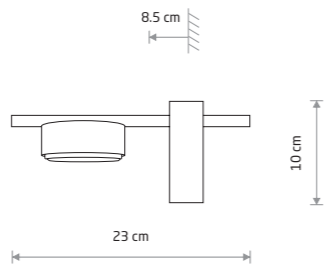

PILLS

■ painted aluminum, painted steel

■ 8265

● 1xGX53, max 12W only LED

PILLS 8263

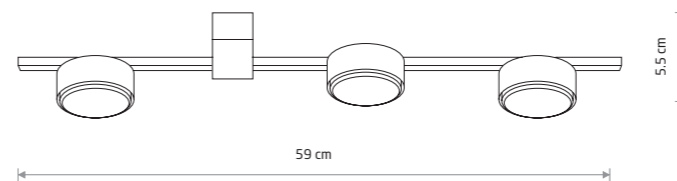

PILLS

■ painted aluminum, painted steel

□ 8268 ■ 8263

● 3xGX53, max 12W only LED



PILLS 8266

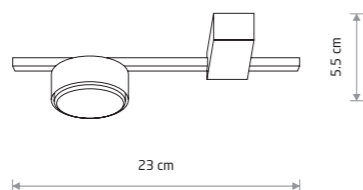

PILLS

■ painted aluminum, painted steel

■ 8266

● 1xGX53, max 12W only LED

PILLS 8262

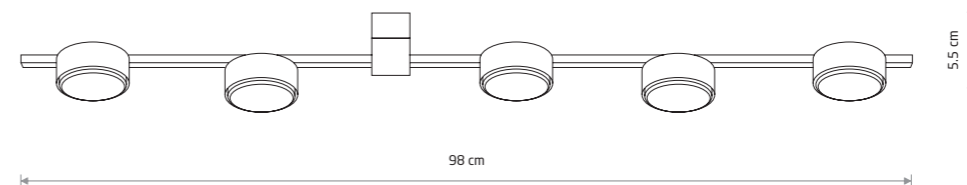

PILLS 8264

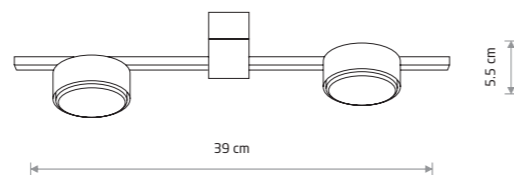

PILLS

■ painted aluminum, painted steel

□ 8270 ■ 8264

● 2xGX53, max 12W only LED

PILLS

■ painted aluminum, painted steel

□ 8267 ■ 8262

● 5xGX53, max 12W only LED



BERGEN 10455

MALMO 10457

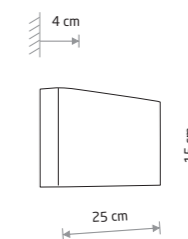

HAGA 10456

**HAGA**

aluminum

10456

2xG9, max 10W only LED

painted steel

 9708 9710

2xG9, max 10W only LED

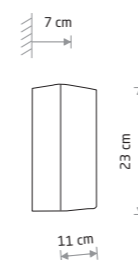
**BERGEN**

aluminum

10455

2xGU10 R50, max 10W only LED

painted steel

 9706 9707

2xGU10 R50, max 10W only LED

**MALMO**

aluminum

10457

2xGU10 R50, max 10W only LED

painted steel

 9705

2xGU10 R50, max 10W only LED

RING MIRROR LED L
10278



RING MIRROR LED M
10277



RING MIRROR LED S 10276

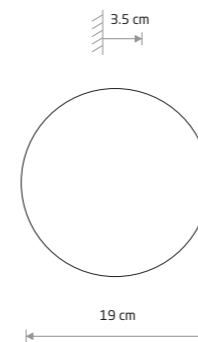

RING MIRROR LED S
glass, painted steel

10276

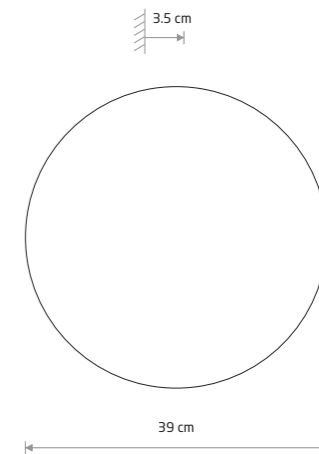

RING MIRROR LED L
glass, painted steel

10278

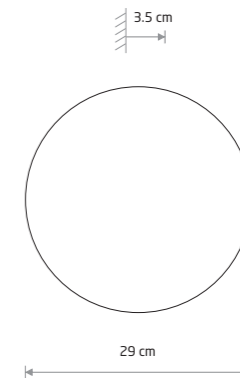

RING MIRROR LED M
glass, painted steel

10277



Item No.	Power	Colour temp.	Luminous flux	Colour Rendering Index (CRI)	Input	Safety type	Power factor	Ingress protection	Lifetime
10276	7W LED	3000K	30 lm	>90	~220-230 V, 50/60 Hz	⊕	>0.5	IP20	30000h
10277	10W LED	3000K	60 lm	>90	~220-230 V, 50/60 Hz	⊕	>0.5	IP20	30000h
10278	13W LED	3000K	90 lm	>90	~220-230 V, 50/60 Hz	⊕	>0.5	IP20	30000h



RING LED S 7634



RING LED S 7637



RING LED S 10317



RING LED S 10315

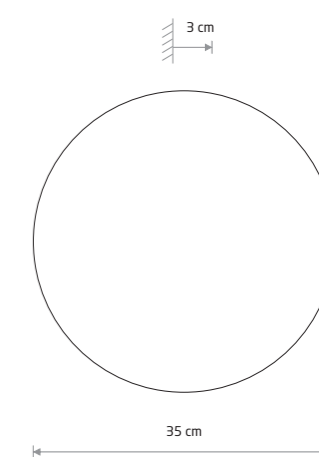
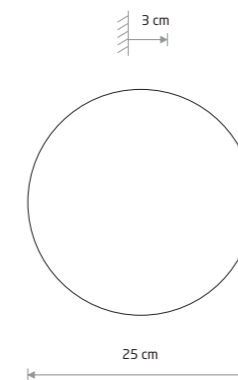
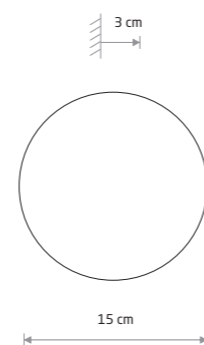
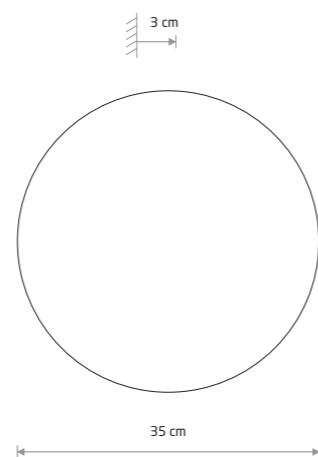
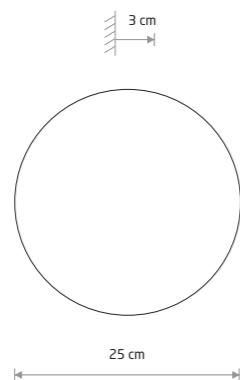
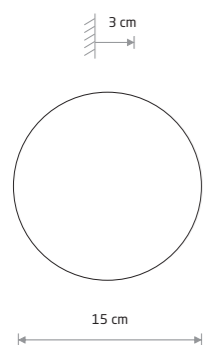

RING LED S

painted steel

■ 7634 ■ 7637



RING LED M

painted steel

■ 7635 ■ 7638



RING LED L

painted steel

■ 7636 ■ 7640



RING LED S

painted steel

■ 10315 ■ 10316 ■ 10317



RING LED M

painted steel

■ 10352 ■ 10347 ■ 10350



RING LED L

painted steel

■ 10353 ■ 10348 ■ 10351



Item No.	Power	Colour temp.	Luminous flux	Colour Rendering Index (CRI)	Input	Safety type	Ingress protection	Lifetime
7634	7W LED	3000K	60 lm	>90	~220-230 V, 50/60 Hz	⊕	IP20	30000h
7637	7W LED	3000K	60 lm	>90	~220-230 V, 50/60 Hz	⊕	IP20	30000h
7635	10W LED	3000K	130 lm	>90	~220-230 V, 50/60 Hz	⊕	IP20	30000h
7638	10W LED	3000K	130 lm	>90	~220-230 V, 50/60 Hz	⊕	IP20	30000h
7636	13W LED	3000K	160 lm	>90	~220-230 V, 50/60 Hz	⊕	IP20	30000h
7640	13W LED	3000K	160 lm	>90	~220-230 V, 50/60 Hz	⊕	IP20	30000h

Item No.	Power	Colour temp.	Luminous flux	Colour Rendering Index (CRI)	Input	Safety type	Power factor	Ingress protection	Lifetime
10315	7W LED	3000K	60 lm	>90	~220-230 V, 50/60 Hz	⊕	>0.5	IP20	30000h
10316	7W LED	3000K	60 lm	>90	~220-230 V, 50/60 Hz	⊕	>0.5	IP20	30000h
10317	7W LED	3000K	60 lm	>90	~220-230 V, 50/60 Hz	⊕	>0.5	IP20	30000h
10347	10W LED	3000K	130 lm	>90	~220-230 V, 50/60 Hz	⊕	>0.5	IP20	30000h
10350	10W LED	3000K	130 lm	>90	~220-230 V, 50/60 Hz	⊕	>0.5	IP20	30000h
10352	10W LED	3000K	130 lm	>90	~220-230 V, 50/60 Hz	⊕	>0.5	IP20	30000h
10348	13W LED	3000K	160 lm	>90	~220-230 V, 50/60 Hz	⊕	>0.5	IP20	30000h
10351	13W LED	3000K	160 lm	>90	~220-230 V, 50/60 Hz	⊕	>0.5	IP20	30000h
10353	13W LED	3000K	160 lm	>90	~220-230 V, 50/60 Hz	⊕	>0.5	IP20	30000h

COMMA LED M 11877

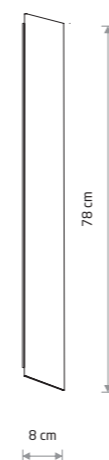
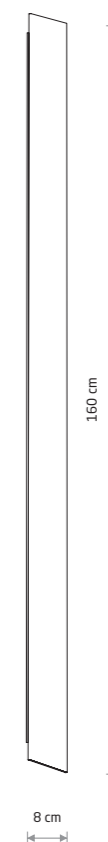
COMMA LED S
11876COMMA LED S
painted steel, plastic PC
 11876 11884
COMMA LED M
11877COMMA LED M
painted steel, plastic PC
 11877 11883
COMMA LED L
11878COMMA LED L
painted steel, plastic PC
 11878 11882

Item No.	Power	Colour temp.	Luminous flux	Beam angle	Colour Rendering Index (CRI)	Input	Safety type	Power factor	Ingress protection	Lifetime
11876	19W LED	3000K	500 lm	70°	>90	~220-230 V, 50/60 Hz	⊕	>0.9	IP20	30000h
11884	19W LED	3000K	850 lm	70°	>90	~220-230 V, 50/60 Hz	⊕	>0.9	IP20	30000h
11877	25W LED	3000K	650 lm	70°	>90	~220-230 V, 50/60 Hz	⊕	>0.9	IP20	30000h
11883	25W LED	3000K	1200 lm	70°	>90	~220-230 V, 50/60 Hz	⊕	>0.9	IP20	30000h
11878	34W LED	3000K	950 lm	70°	>90	~220-230 V, 50/60 Hz	⊕	>0.9	IP20	30000h
11882	34W LED	3000K	1650 lm	70°	>90	~220-230 V, 50/60 Hz	⊕	>0.9	IP20	30000h

 WHITE P004 RAL 9003 BLACK P013 RAL 9005



RADIUS 7762

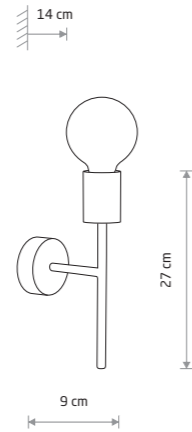

RADIUS
painted steel

■ 7762

● 1xE27, max 25W only LED

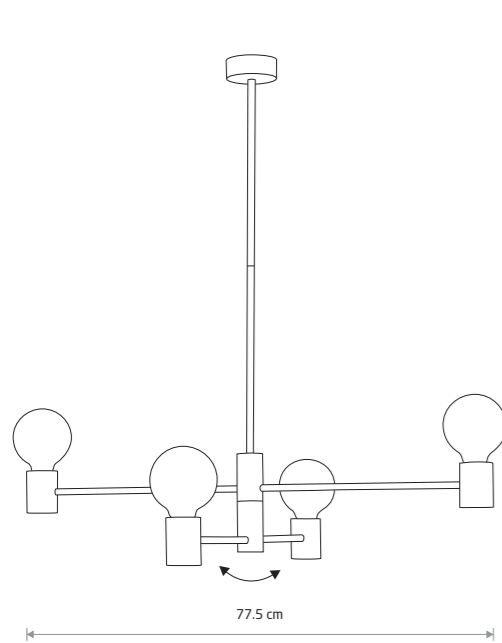

RADIUS
painted steel

■ 7931

● 4xE27, max 25W only LED

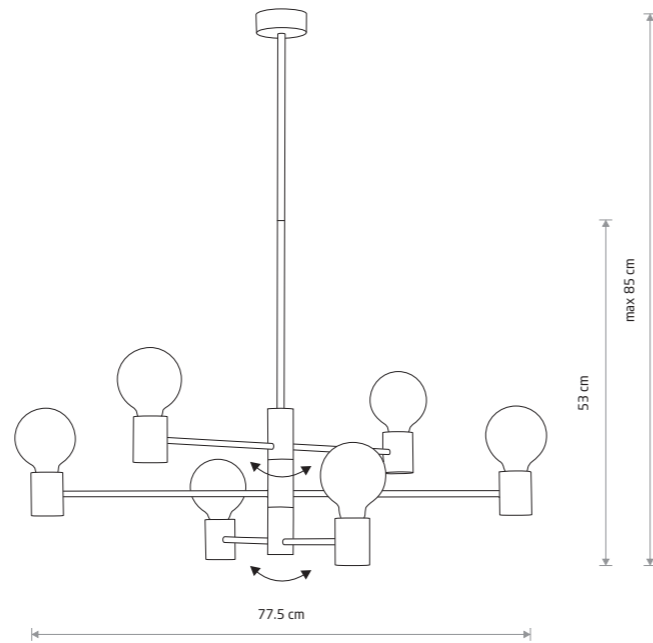

RADIUS
painted steel

■ 7932

● 6xE27, max 25W only LED



RADIUS 7932



WORKSHOP B 6336



WORKSHOP A 6337

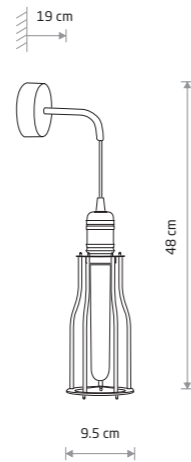

WORKSHOP

painting steel, copper-clad steel

6605

1xE27, max 25W only LED

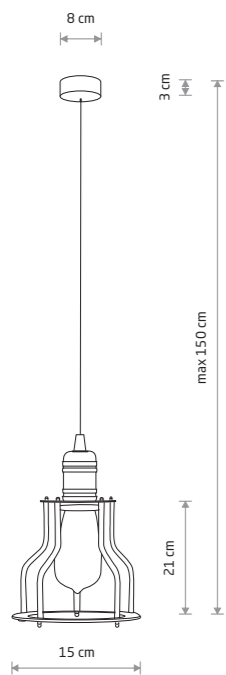

WORKSHOP B

painting steel, copper-clad steel

6336

1xE27, max 25W only LED

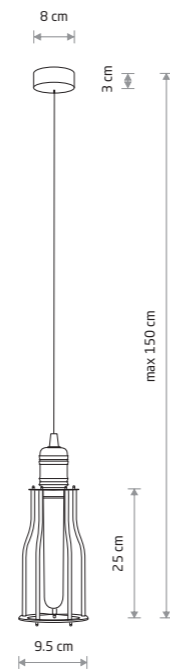

WORKSHOP A

painting steel, copper-clad steel

6337

1xE27, max 25W only LED

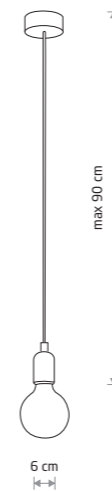

SILICONE

silicone, painting steel

6404 6403

1xE27, max 25W only LED



SILICONE 6404



SILICONE 6403



SPIDER 6785



TWIG 9138

X+Y=max 300 cm

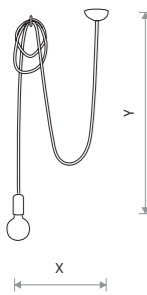

SPIDER
braided cable, painted steel

■ 6792

● 1xE27, max 25W only LED

X+Y=max 300 cm

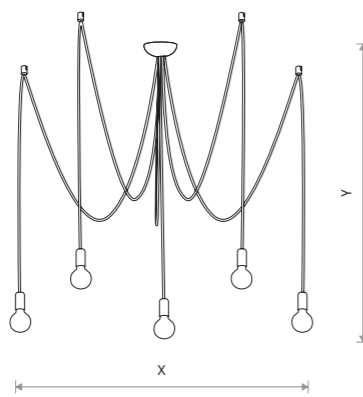

SPIDER
braided cable, painted steel

□ 9744 ■ 6788

● 5xE27, max 25W only LED

X+Y=max 300 cm

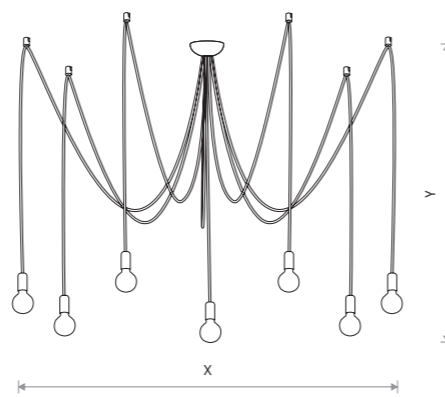

SPIDER
braided cable, painted steel

□ 9743 ■ 6785

● 7xE27, max 25W only LED

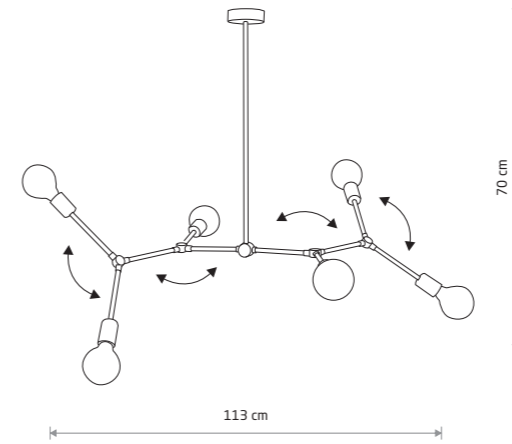

TWIG
painted steel

■ 9138

● 6xE27, max 25W only LED

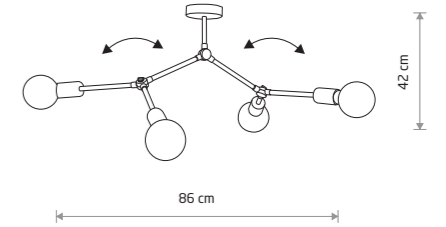

TWIG
painted steel

■ 9140

● 4xE27, max 25W only LED



CRATE 9046



CRATE 9045



CRATE 9047



PLANT 9381



PLANT 9382

18 cm

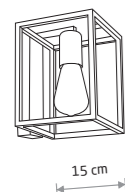
CRATE
painted steel

■ 9046

● 1xE27, max 25W only LED

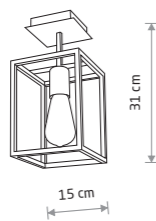
CRATE
painted steel

■ 9045

● 1xE27, max 25W only LED

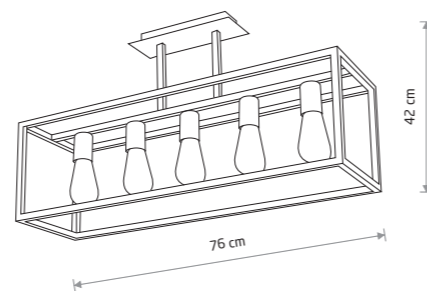
CRATE
painted steel

■ 9047

● 5xE27, max 25W only LED

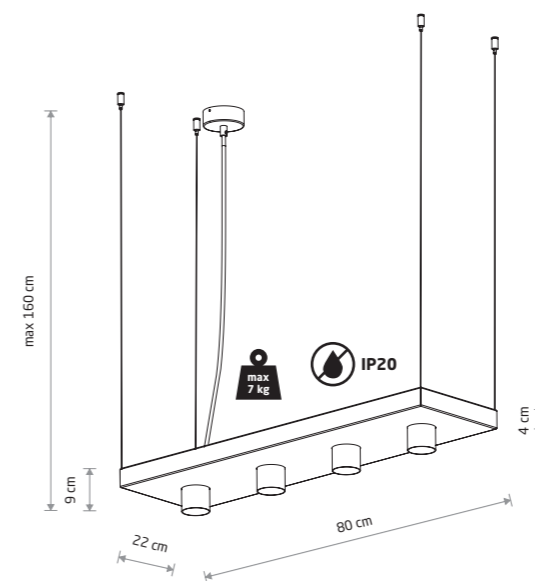
PLANT
painted steel, steel

□ 9382 ■ 9381

● 4xGU10 R50, max 10W only LED

TECHNO 9145

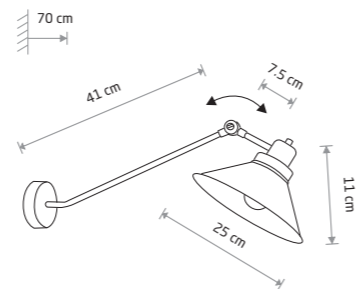

TECHNO

■ painted steel

■ 9145

■ 1xE27, max 25W only LED

TECHNO 9142

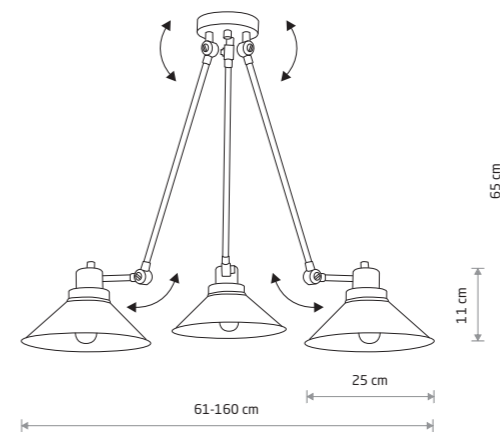

TECHNO

■ painted steel

■ 9142

■ 3xE27, max 25W only LED

HARMONY 9890

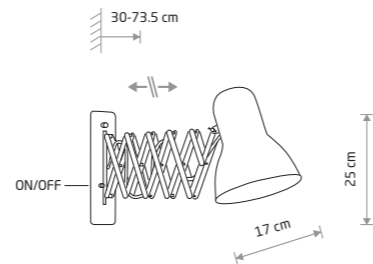

HARMONY

■ painted steel, chrome

■ 9890

■ 1xE27, max 25W only LED



PANTOGRAPH 9126

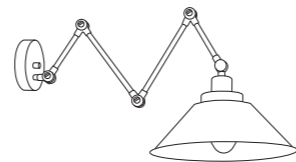
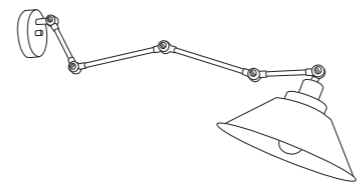
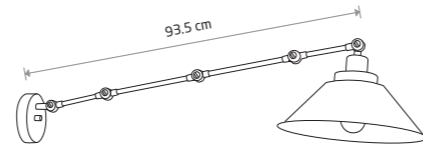
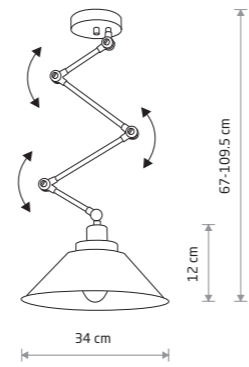

PANTOGRAPH 9126

PANTOGRAPH

■ painted steel

■ 9126

🔌 1xE27, max 25W only LED



CRAFT 9150



CRAFT 9151

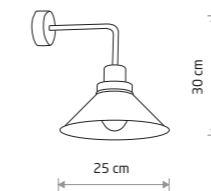

CRAFT

■ painted steel

■ 9151

🔌 1xE27, max 25W only LED

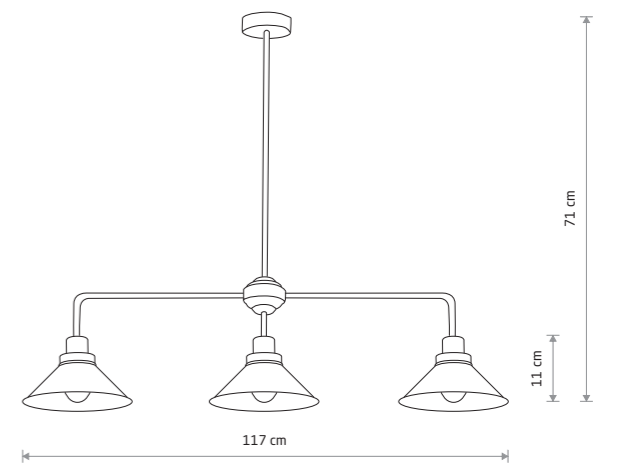

CRAFT

■ painted steel

■ 9150

🔌 3xE27, max 25W only LED



HIGH-BAY 5067

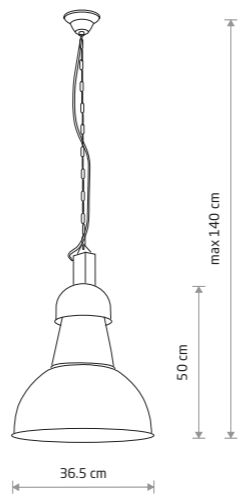

HIGH-BAY

■ painted steel

■ 5067

● 1xE27, max 25W only LED



GARRET 6442

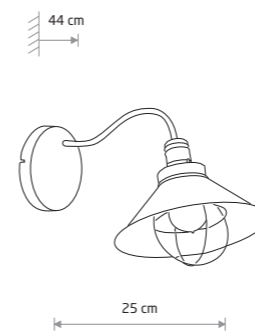

GARRET

■ painted steel

■ 6442

● 1xE27, max 25W only LED



GARRET M 6444

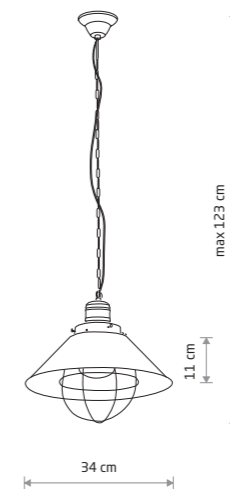

GARRET S

■ painted steel

■ 6443

● 1xE27, max 25W only LED

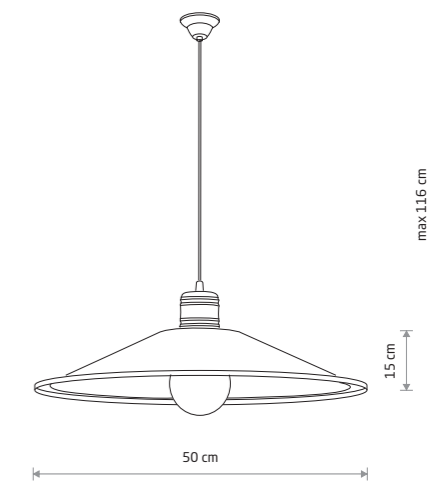

GARRET M

■ painted steel

■ 6444

● 1xE27, max 25W only LED



HEMISPHERE RUST L
6368



HEMISPHERE SUPER S
10618

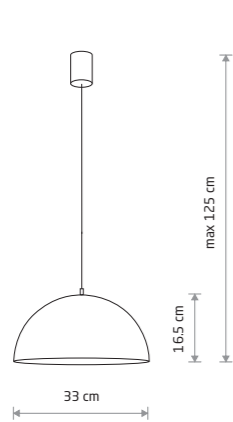

HEMISPHERE RUST S

painting steel

6367

1xE27, max 25W only LED

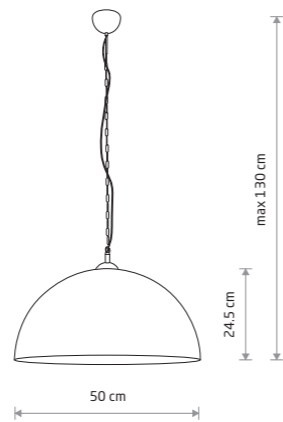

HEMISPHERE RUST L

painting steel

6368

1xE27, max 25W only LED

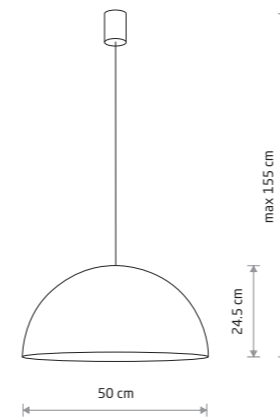

HEMISPHERE SUPER L

painting steel, braided cable

10296

4xGX53, max 12W only LED

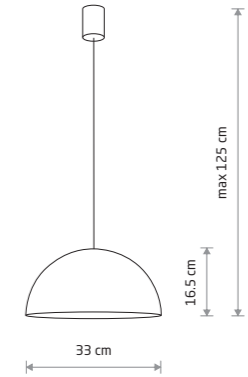

HEMISPHERE SUPER S

painting steel, braided cable

10618

1xGX53, max 12W only LED

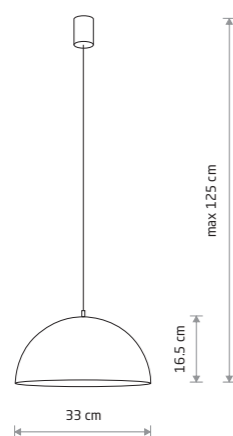

HEMISPHERE HIT L 10703

HEMISPHERE SUPER S
10701HEMISPHERE SUPER L
10696

HEMISPHERE HIT S

painted steel

10702

1xE27, max 25W only LED

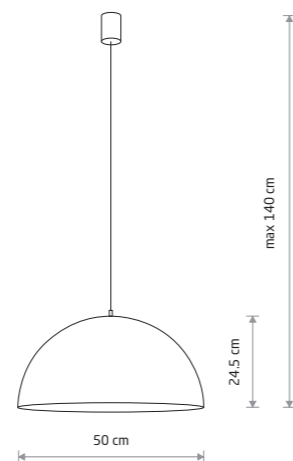

HEMISPHERE HIT L

painted steel

10703

1xE27, max 25W only LED

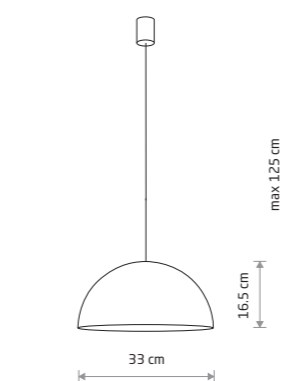

HEMISPHERE SUPER S

painted steel, braided cable

10695 10701

1xGX53, max 12W only LED

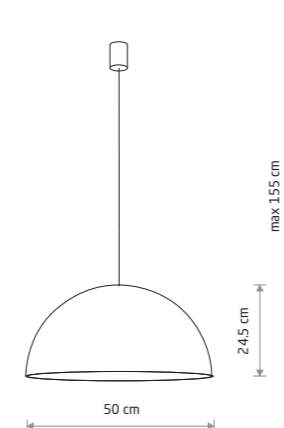

HEMISPHERE SUPER L

painted steel, braided cable

10696 10700

4xGX53, max 12W only LED



CANOE 7927



EGG L 9023

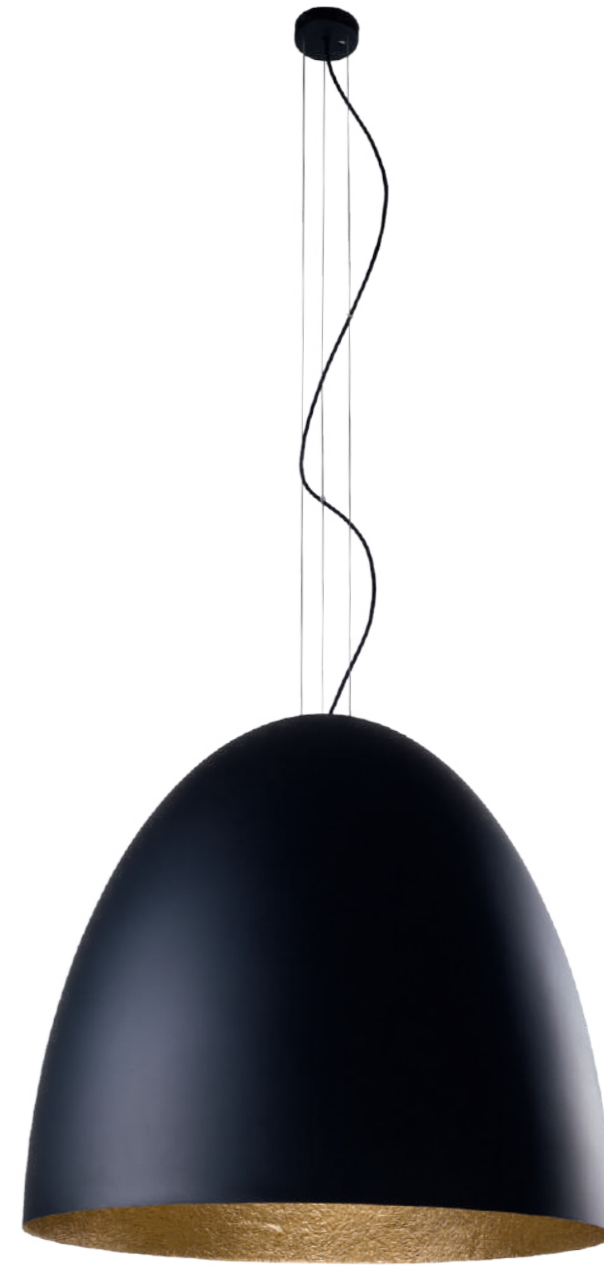

EGG XL 9026

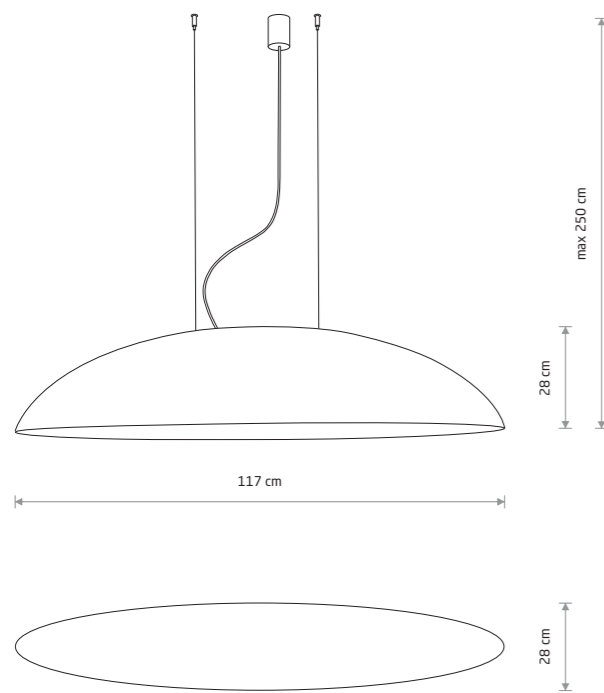

CANOE

composite, painted steel, steel

7926 7927

5xE27, max 25W only LED

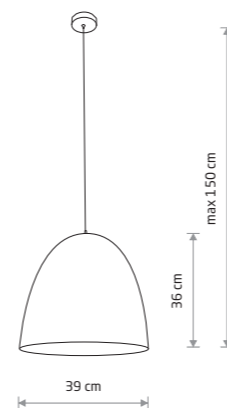

EGG M

composite, painted steel

9022 9021

1xE27, max 25W only LED

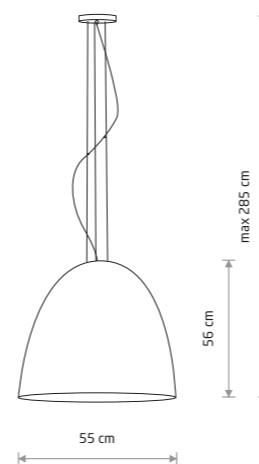

EGG L

composite, painted steel, steel

9024 9023

5xE27, max 25W only LED

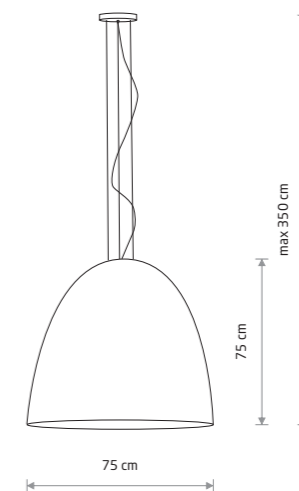

EGG XL

composite, painted steel, steel

9026 9025

7xE27, max 25W only LED



ARES 206

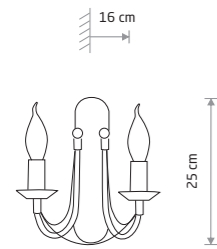

ARES
painted steel

203

2xE14, max 10W only LED

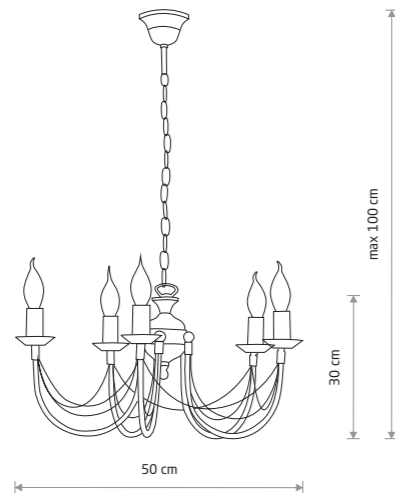

ARES
painted steel

205

5xE14, max 10W only LED

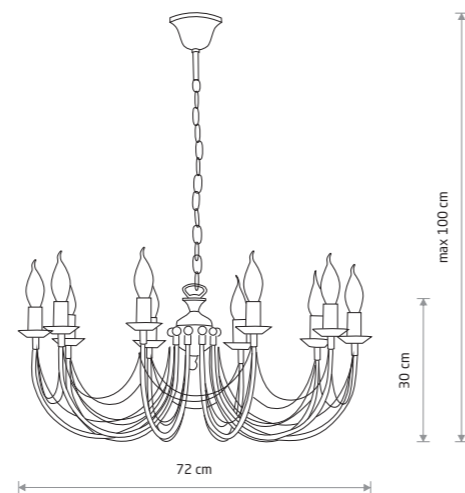

ARES
painted steel

206

10xE14, max 10W only LED

BLACK WITH A GOLDEN PATINA



GIOTTO LED M 8170

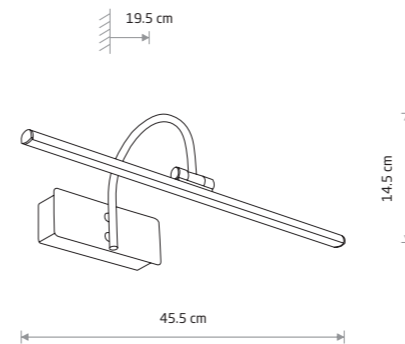

GIOTTO LED S
brass plated steel

8168

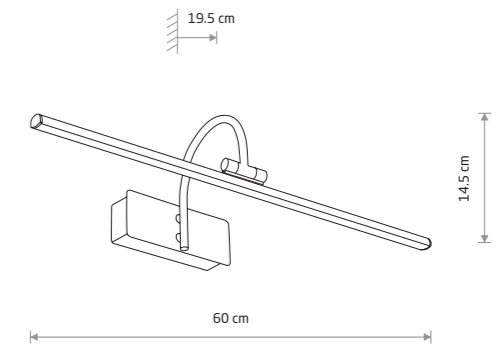

GIOTTO LED M
brass plated steel

8170

Item No.	Power	Colour temp.	Luminous flux	Beam angle	Colour Rendering Index (CRI)	Input	Safety type	Power factor	Ingress protection	Lifetime
8168	9W LED	3000K	600 lm	120°	≥80	~220-230 V, 50/60 Hz	⊕	>0.5	IP20	30000h
8170	13W LED	3000K	900 lm	120°	≥80	~220-230 V, 50/60 Hz	⊕	>0.5	IP20	30000h

ANTIQUE BRASS



ORGANIC 8304



ORGANIC 8305

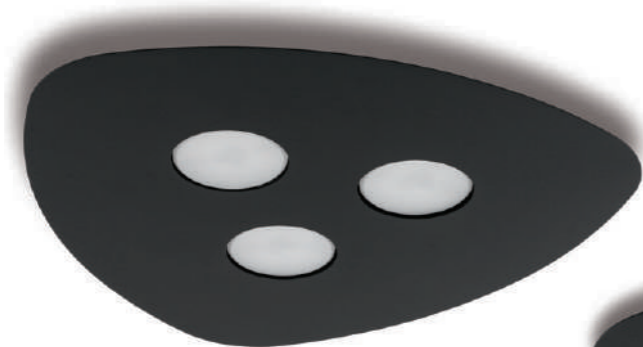

ORGANIC 8302



ORGANIC 8303

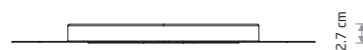
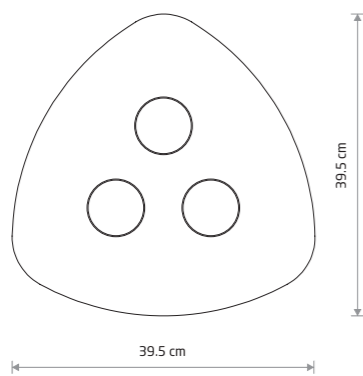

ORGANIC

painting steel

8304 8302

3xGX53, max 12W

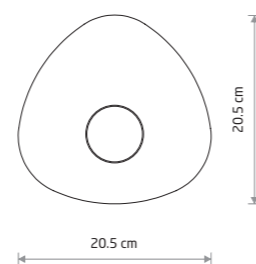

ORGANIC

painting steel

8305 8303

1xGX53, max 12W

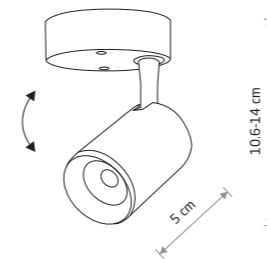

IRIS LED

painting aluminum, plastic

8993 8994



IRIS LED 8993

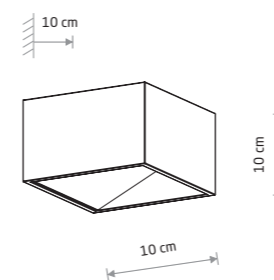

LIA LED

painting aluminum

6913



LIA LED 6913

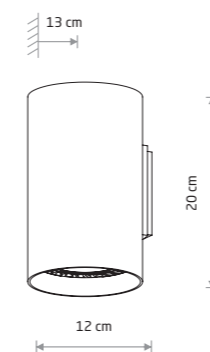

TUBE

painting aluminum

9317 9320

2xGU10 ES111, max 15W only LED



TUBE 9317

Item No.	Power	Colour temp.	Luminous flux	Beam angle	Colour Rendering Index (CRI)	Input	Safety type	Power factor	Ingress protection	Lifetime
8993	7W LED	3000K	550 lm	30°	≥ 80	~220-230 V, 50/60 Hz	⊕	>0.5	IP20	30000h
8994	7W LED	3000K	530 lm	30°	≥ 80	~220-230 V, 50/60 Hz	⊕	>0.5	IP20	30000h
6913	7W LED	3000K	460 lm	89°	≥ 80	~220-230 V, 50/60 Hz	⊕	>0.5	IP20	10000h



STRAIGHT CEILING LED L 7551



STRAIGHT CEILING LED M 7558



STRAIGHT CEILING LED S 7597

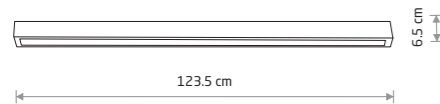

STRAIGHT CEILING LED L

painting steel, plastic PMMA

■ 7551 □ 7556 ■ 7600

☑ 1xLED TUBE T8, max 22W, included

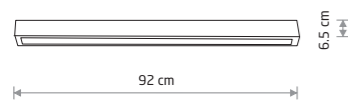

STRAIGHT CEILING LED M

painting steel, plastic PMMA

■ 7553 □ 7558 ■ 7598

☑ 1xLED TUBE T8, max 16W, included

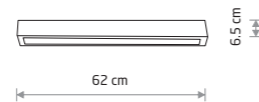

STRAIGHT CEILING LED S

painting steel, plastic PMMA

■ 7552 □ 7557 ■ 7597

☑ 1xLED TUBE T8, max 11W, included



STRAIGHT WALL LED M 7561



STRAIGHT WALL LED S 7568



STRAIGHT WALL XS 7601

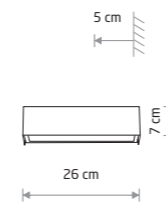

STRAIGHT WALL XS

painting steel, plastic PMMA

□ 6345 ■ 6350 ■ 7601

☑ 1xLED TUBE T8, max 10W only LED

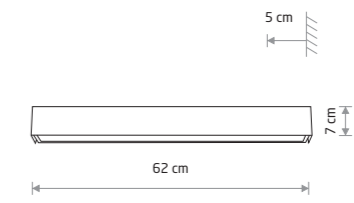

STRAIGHT WALL LED S

painting steel, plastic PMMA

□ 7568 ■ 7562 ■ 7596

☑ 1xLED TUBE T8, max 11W, included

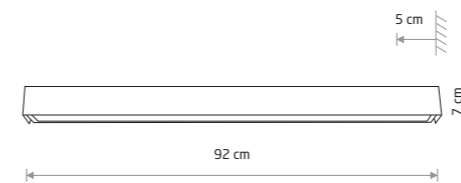

STRAIGHT WALL LED M

painting steel, plastic PMMA

□ 7567 ■ 7561 ■ 7594

☑ 1xLED TUBE T8, max 16W, included

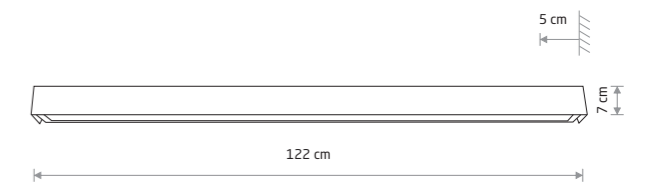

STRAIGHT WALL LED L

painting steel, plastic PMMA

□ 7566 ■ 7560 ■ 7595

☑ 1xLED TUBE T8, max 22W, included

Name	Size	Power	Colour temp.	Luminous flux	Beam angle	Colour Rendering Index (CRI)	Input	Power factor	Lifetime	Material
LED TUBE T8	60 cm	11W LED	3000K	1700 lm	120°	≥80	~220-230 V, 50/60 Hz	>0,5	30000h	CLEAR GLASS
LED TUBE T8	90 cm	16W LED	3000K	2300 lm	120°	≥80	~220-230 V, 50/60 Hz	>0,5	30000h	CLEAR GLASS
LED TUBE T8	120 cm	22W LED	3000K	3200 lm	120°	≥80	~220-230 V, 50/60 Hz	>0,5	30000h	CLEAR GLASS

Name	Size	Power	Colour temp.	Luminous flux	Beam angle	Colour Rendering Index (CRI)	Input	Power factor	Lifetime	Material
LED TUBE T8	60 cm	11W LED	3000K	1700 lm	120°	≥80	~220-230 V, 50/60 Hz	>0,5	30000h	CLEAR GLASS
LED TUBE T8	90 cm	16W LED	3000K	2300 lm	120°	≥80	~220-230 V, 50/60 Hz	>0,5	30000h	CLEAR GLASS
LED TUBE T8	120 cm	22W LED	3000K	3200 lm	120°	≥80	~220-230 V, 50/60 Hz	>0,5	30000h	CLEAR GLASS

SOFT WALL LED 60X6 7528



SOFT WALL LED 60X6

painting aluminum, plastic PMMA

7541 7528

1xLED TUBE T8, max 11W, included



SOFT LED 90X6 7535

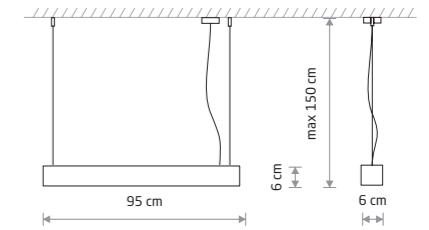

SOFT LED 90X6

painting aluminum, plastic PMMA

7547 7535

1xLED TUBE T8, max 16W, included

SOFT WALL LED 90X6 7534

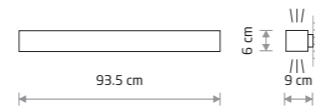

SOFT WALL LED 90X6

painting aluminum, plastic PMMA

7548 7534

1xLED TUBE T8, max 16W, included



SOFT LED 120X6 7525

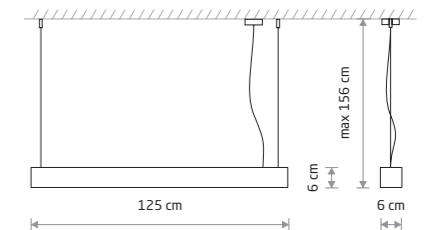

SOFT LED 120X6

painting aluminum, plastic PMMA

7537 7525

1xLED TUBE T8, max 22W, included

Name	Size	Power	Colour temp.	Luminous flux	Beam angle	Colour Rendering Index (CRI)	Input	Power factor	Lifetime	Material
LED TUBE T8	60 cm	11W LED	3000K	1700 lm	120°	≥80	~220-230 V, 50/60 Hz	>0,5	30000h	CLEAR GLASS
LED TUBE T8	90 cm	16W LED	3000K	2300 lm	120°	≥80	~220-230 V, 50/60 Hz	>0,5	30000h	CLEAR GLASS
LED TUBE T8	120 cm	22W LED	3000K	3200 lm	120°	≥80	~220-230 V, 50/60 Hz	>0,5	30000h	CLEAR GLASS

Name	Size	Power	Colour temp.	Luminous flux	Beam angle	Colour Rendering Index (CRI)	Input	Power factor	Lifetime	Material
LED TUBE T8	60 cm	11W LED	3000K	1700 lm	120°	≥80	~220-230 V, 50/60 Hz	>0,5	30000h	CLEAR GLASS
LED TUBE T8	90 cm	16W LED	3000K	2300 lm	120°	≥80	~220-230 V, 50/60 Hz	>0,5	30000h	CLEAR GLASS
LED TUBE T8	120 cm	22W LED	3000K	3200 lm	120°	≥80	~220-230 V, 50/60 Hz	>0,5	30000h	CLEAR GLASS

WHITE P004 RAL 9003 GRAPHITE P010 RAL 7016

WHITE P004 RAL 9003 GRAPHITE P010 RAL 7016

SOFT CEILING LED 60X6 7527

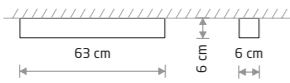

SOFT CEILING LED 60X6

painting aluminum, plastic PMMA

7540 7527

1xLED TUBE T8, max 11W, included

SOFT CEILING LED 60X20 7526



SOFT CEILING LED 60X20

painting aluminum, plastic PMMA

7538 7526

2xLED TUBE T8, max 11W, included

SOFT CEILING LED 90X6 7533

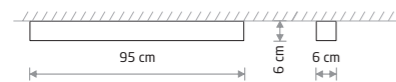

SOFT CEILING LED 90X6

painting aluminum, plastic PMMA

7546 7533

1xLED TUBE T8, max 16W, included

SOFT CEILING LED 90X20 7531

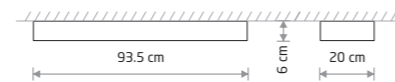

SOFT CEILING LED 90X20

painting aluminum, plastic PMMA

7542 7531

2xLED TUBE T8, max 16W, included

SOFT CEILING LED 120X6 7524

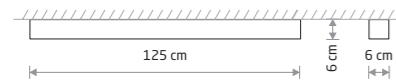

SOFT CEILING LED 120X6

painting aluminum, plastic PMMA

7536 7524

1xLED TUBE T8, max 22W, included

SOFT CEILING LED 60X60 7530

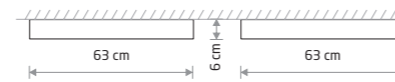

SOFT CEILING LED 60X60

painting aluminum, plastic PMMA

7544 7530

5xLED TUBE T8, max 11W, included

ION LED M 8171

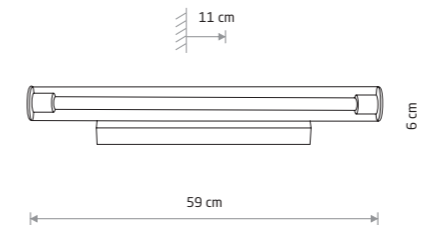

ION LED M

glass, chrome plated steel

8171

ION LED L 8172

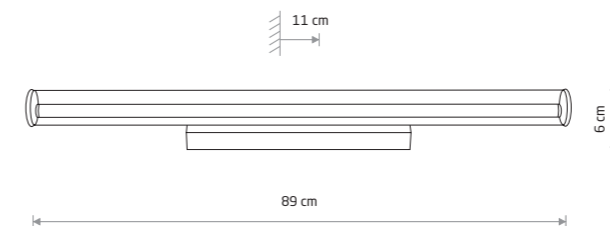

ION LED L

glass, chrome plated steel

8172

Item No.	Power	Colour temp.	Luminous flux	Beam angle	Colour Rendering Index (CRI)	Input	Safety type	Power factor	Ingress protection	Lifetime
8171	12W LED	3000K	870 lm	130°	≥80	~220-230 V, 50/60 Hz	⊕	>0.5	IP20	30000h
8172	18W LED	3000K	1300 lm	130°	≥80	~220-230 V, 50/60 Hz	⊕	>0.5	IP20	30000h



CL OFFICE LED PRO 120
10212



CL OFFICE LED PRO 150
10213



CL OFFICE LED PRO 120

painting aluminum, plastic PMMA

- 10208 3000K ■ 10210 4000K
- 10212 4000K

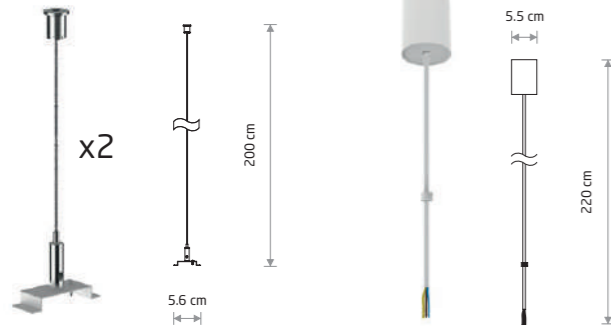
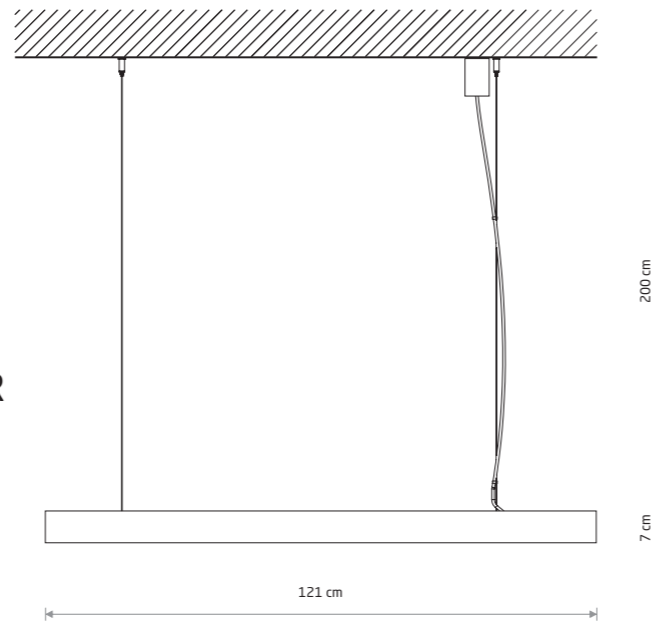
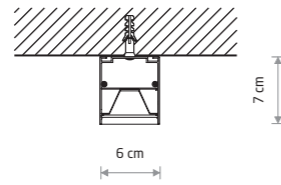
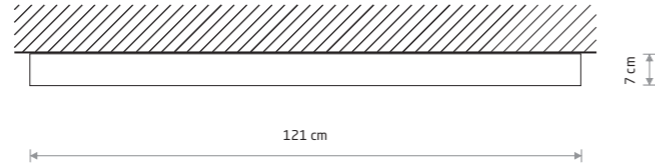

CL OFFICE PRO/HALL PRO SUSPENSION KIT

steel, painted steel

- 8291 ■ 8250

CL OFFICE PRO/HALL PRO POWER SUPPLY KIT

painted steel

- 8290 ■ 8288

CL OFFICE LED PRO 150

chrome plated aluminum, plastic PMMA

- 10213 3000K ■ 10214 4000K

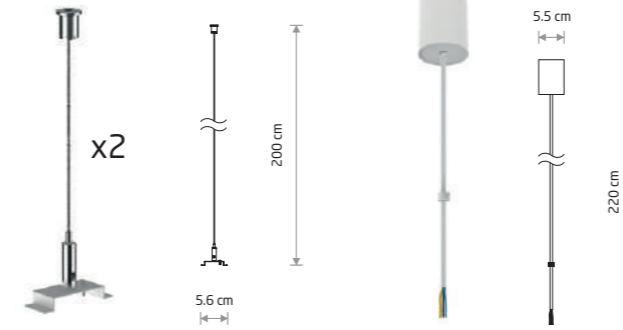
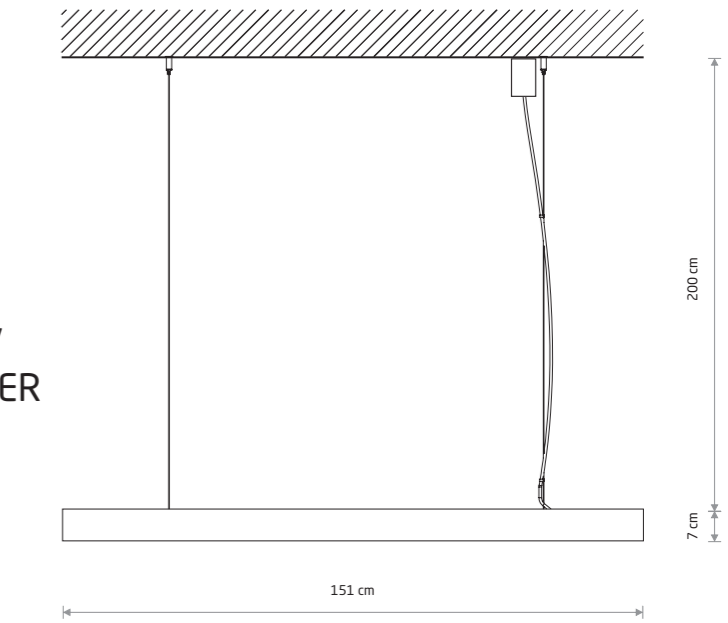
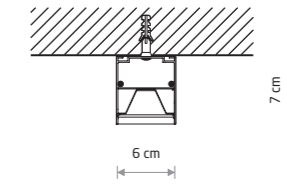
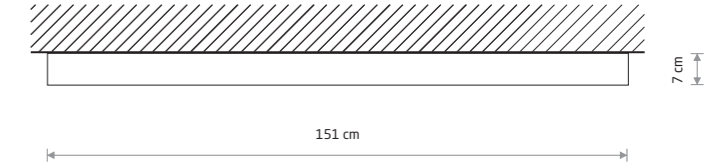

CL OFFICE PRO/HALL PRO SUSPENSION KIT

steel, painted steel

- 8250

CL OFFICE PRO/HALL PRO POWER SUPPLY KIT

painted steel

- 8288

Item No.	Power	Colour temp.	Luminous flux	Beam angle	Colour Rendering Index (CRI)	Input	LED brand	Driver brand	Ingress protection	Lifetime	Warranty
10212	31W LED	4000K	4160 lm	90°	≥ 80	~220-230 V, 50/60 Hz	PHILIPS	PHILIPS	IP20	50000h	5 YEARS
10208	31W LED	3000K	3490 lm	90°	≥ 80	~220-230 V, 50/60 Hz	PHILIPS	PHILIPS	IP20	50000h	5 YEARS
10210	31W LED	4000K	3610 lm	90°	≥ 80	~220-230 V, 50/60 Hz	PHILIPS	PHILIPS	IP20	50000h	5 YEARS

Item No.	Power	Colour temp.	Luminous flux	Beam angle	Colour Rendering Index (CRI)	Input	LED brand	Driver brand	Ingress protection	Lifetime	Warranty
10213	40W LED	3000K	4540 lm	83°	≥ 80	~220-230 V, 50/60 Hz	PHILIPS	PHILIPS	IP20	50000h	5 YEARS
10214	40W LED	4000K	4710 lm	83°	≥ 80	~220-230 V, 50/60 Hz	PHILIPS	PHILIPS	IP20	50000h	5 YEARS



MULTI LED 11357

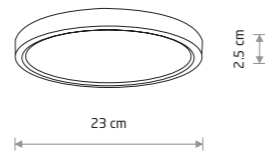

MULTI LED

plastic, aluminium

11357



MULTI LED 11358

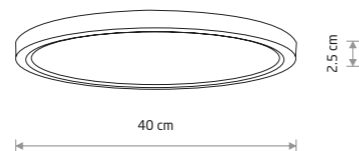

MULTI LED

plastic, aluminium

11358



Możliwość zmiany mocy oprawy oświetleniowej (W)
Selectable luminaire wattage (W)



11358 - 18W



11358 - 24W



11358 - 30W

Możliwość zmiany temperatury barwowej (K)
Selectable colour temperature (K)



11358 - 6000K



11358 - 4000K



11358 - 3000K

Sposoby montażu / Installation methods

- 1. Natynkowy
- 1. Surface-mounted

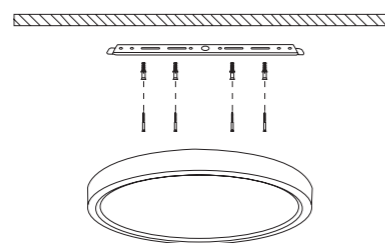

- 2. Podtynkowy
- 2. Flush-mounted

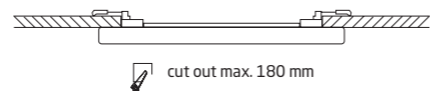
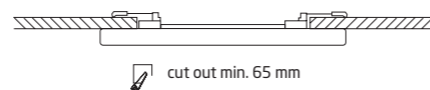
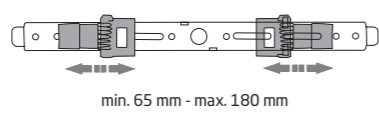
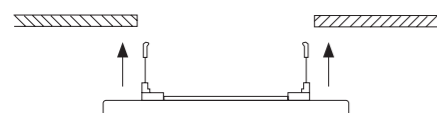

Możliwość wyboru temperatury barwowej (K) oraz mocy (W)
Selectable colour temperature (K) and wattage (W)

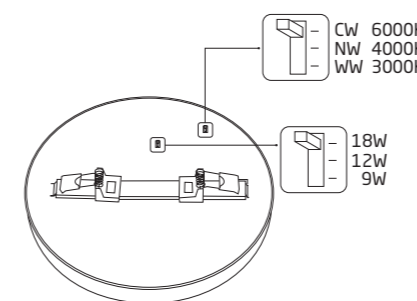

Możliwość wyboru temperatury barwowej (K) oraz mocy (W)
Selectable colour temperature (K) and wattage (W)

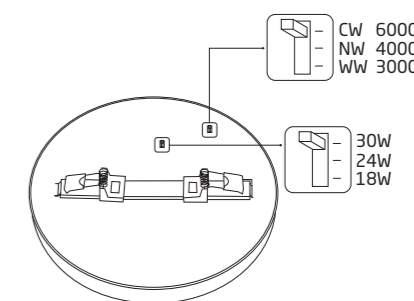

Item No.	Power	Colour temp.	Luminous flux	Beam angle	Colour Rendering Index (CRI)	Input	Safety type	Power factor	Ingress protection	Lifetime
11357	9W/12W/18W LED	CCT CHANGE 3000-6000K	900/1200/1600 lm	110°	>80	~220-230 V, 50/60 Hz	☑	>0.9	IP20	30000h
11358	18W/24W/30W LED	CCT CHANGE 3000-6000K	1800/2400/2900 lm	110°	>80	~220-230 V, 50/60 Hz	☑	>0.9	IP20	30000h



NIKKI ROUND LED 48W
11207



NIKKI ROUND LED 60W 11202

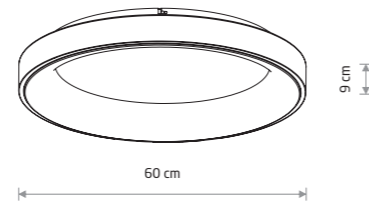
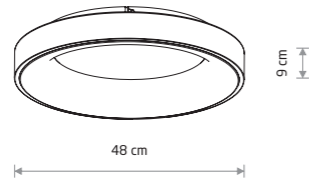
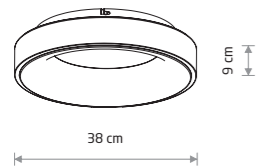

NIKKI ROUND LED

painted steel, plastic PMMA

■ 11200 3000K ■ 11203 4000K

■ 11206 3000K ■ 11210 4000K



NIKKI ROUND LED

painted steel, plastic PMMA

■ 11201 3000K ■ 11204 4000K

■ 11207 3000K ■ 11211 4000K



NIKKI ROUND LED

painted steel, plastic PMMA

■ 11202 3000K ■ 11205 4000K

■ 11208 3000K ■ 11212 4000K



Item No.	Power	Colour temp.	Luminous flux	Beam angle	Colour Rendering Index (CRI)	Input	Safety type	Ingress protection	Lifetime
11200	32W LED	3000K	2700 lm	120°	>80	~220-230 V, 50/60 Hz	□	IP20	40000h
11201	48W LED	3000K	4200 lm	120°	>80	~220-230 V, 50/60 Hz	□	IP20	40000h
11202	60W LED	3000K	5400 lm	120°	>80	~220-230 V, 50/60 Hz	□	IP20	40000h
11203	32W LED	4000K	2800 lm	120°	>80	~220-230 V, 50/60 Hz	□	IP20	40000h
11204	48W LED	4000K	4300 lm	120°	>80	~220-230 V, 50/60 Hz	□	IP20	40000h
11205	60W LED	4000K	5600 lm	120°	>80	~220-230 V, 50/60 Hz	□	IP20	40000h
11206	32W LED	3000K	2600 lm	120°	>80	~220-230 V, 50/60 Hz	□	IP20	40000h
11207	48W LED	3000K	4000 lm	120°	>80	~220-230 V, 50/60 Hz	□	IP20	40000h
11208	60W LED	3000K	5200 lm	120°	>80	~220-230 V, 50/60 Hz	□	IP20	40000h
11210	32W LED	4000K	2700 lm	120°	>80	~220-230 V, 50/60 Hz	□	IP20	40000h
11211	48W LED	4000K	4200 lm	120°	>80	~220-230 V, 50/60 Hz	□	IP20	40000h
11212	60W LED	4000K	5400 lm	120°	>80	~220-230 V, 50/60 Hz	□	IP20	40000h

■ WHITE ■ BLACK



LID ROUND LED 10408

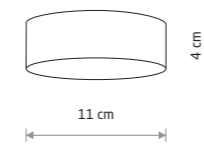

LID ROUND LED 15W

plastic

- 10402 3000K 10411 4000K
- 10406 3000K 10415 4000K

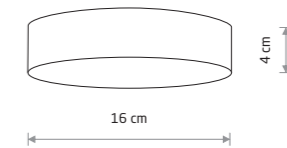

LID ROUND LED 25W

plastic

- 10403 3000K 10412 4000K
- 10407 3000K 10416 4000K

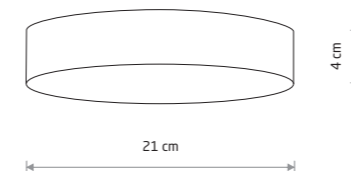

LID ROUND LED 35W

plastic

- 10404 3000K 10413 4000K
- 10408 3000K 10417 4000K

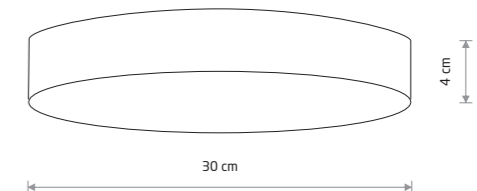

LID ROUND LED 50W

plastic

- 10410 3000K 10418 4000K



Item No.	Power	Colour temp.	Luminous flux	Beam angle	Colour Rendering Index (CRI)	Input	Safety type	Power factor	Ingress protection	Lifetime
10402	15W LED	3000K	1500 lm	120°	>80	~220-230 V, 50/60 Hz	☐	>0.7	IP20	30000h
10411	15W LED	4000K	1600 lm	120°	>80	~220-230 V, 50/60 Hz	☐	>0.7	IP20	30000h
10406	15W LED	3000K	1200 lm	120°	>80	~220-230 V, 50/60 Hz	☐	>0.7	IP20	30000h
10415	15W LED	4000K	1300 lm	120°	>80	~220-230 V, 50/60 Hz	☐	>0.7	IP20	30000h
10403	25W LED	3000K	1900 lm	120°	>80	~220-230 V, 50/60 Hz	☐	>0.9	IP20	30000h
10412	25W LED	4000K	2100 lm	120°	>80	~220-230 V, 50/60 Hz	☐	>0.9	IP20	30000h
10407	25W LED	3000K	1600 lm	120°	>80	~220-230 V, 50/60 Hz	☐	>0.9	IP20	30000h
10416	25W LED	4000K	1800 lm	120°	>80	~220-230 V, 50/60 Hz	☐	>0.9	IP20	30000h
10404	35W LED	3000K	3100 lm	120°	>80	~220-230 V, 50/60 Hz	☐	>0.9	IP20	30000h
10413	35W LED	4000K	3400 lm	120°	>80	~220-230 V, 50/60 Hz	☐	>0.9	IP20	30000h
10408	35W LED	3000K	2700 lm	120°	>80	~220-230 V, 50/60 Hz	☐	>0.9	IP20	30000h
10417	35W LED	4000K	3000 lm	120°	>80	~220-230 V, 50/60 Hz	☐	>0.9	IP20	30000h
10410	50W LED	3000K	4300 lm	120°	>80	~220-230 V, 50/60 Hz	☐	>0.9	IP20	30000h
10418	50W LED	4000K	4500 lm	120°	>80	~220-230 V, 50/60 Hz	☐	>0.9	IP20	30000h

☐ WHITE ■ BLACK

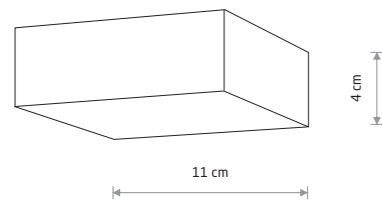

LID SQUARE LED 15W

plastic

10420 3000K 10428 4000K

10424 3000K

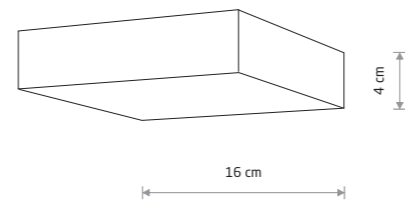

LID SQUARE LED 25W

plastic

10421 3000K 10430 4000K

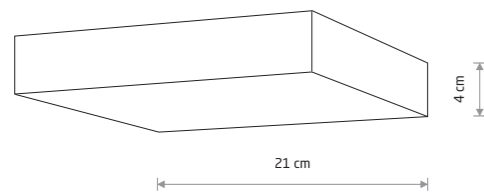

LID SQUARE LED 35W

plastic

10422 3000K 10431 4000K

10426 3000K

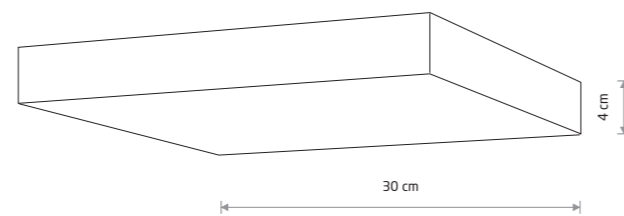

LID SQUARE LED 50W

plastic

10423 3000K 10432 4000K

10427 3000K



LID SQUARE LED 10421

Item No.	Power	Colour temp.	Luminous flux	Beam angle	Colour Rendering Index (CRI)	Input	Safety type	Power factor	Ingress protection	Lifetime
10420	15W LED	3000K	1500 lm	120°	>80	~220-230 V, 50/60 Hz	☐	>0.7	IP20	30000h
10428	15W LED	4000K	1600 lm	120°	>80	~220-230 V, 50/60 Hz	☐	>0.7	IP20	30000h
10424	15W LED	3000K	1200 lm	120°	>80	~220-230 V, 50/60 Hz	☐	>0.7	IP20	30000h
10421	25W LED	3000K	1900 lm	120°	>80	~220-230 V, 50/60 Hz	☐	>0.9	IP20	30000h
10430	25W LED	4000K	2100 lm	120°	>80	~220-230 V, 50/60 Hz	☐	>0.9	IP20	30000h
10422	35W LED	3000K	3100 lm	120°	>80	~220-230 V, 50/60 Hz	☐	>0.9	IP20	30000h
10431	35W LED	4000K	3400 lm	120°	>80	~220-230 V, 50/60 Hz	☐	>0.9	IP20	30000h
10426	35W LED	3000K	2700 lm	120°	>80	~220-230 V, 50/60 Hz	☐	>0.9	IP20	30000h
10423	50W LED	3000K	4600 lm	120°	>80	~220-230 V, 50/60 Hz	☐	>0.9	IP20	30000h
10432	50W LED	4000K	5000 lm	120°	>80	~220-230 V, 50/60 Hz	☐	>0.9	IP20	30000h
10427	50W LED	3000K	4300 lm	120°	>80	~220-230 V, 50/60 Hz	☐	>0.9	IP20	30000h

☐ WHITE ■ BLACK

ARENA LED 10176

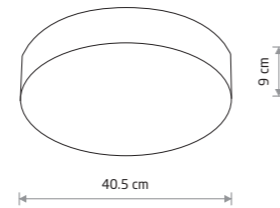

ARENA LED
 painted steel, plastic PMMA
 □ 10185 ■ 10176



KASAI 9490



KASAI 7952

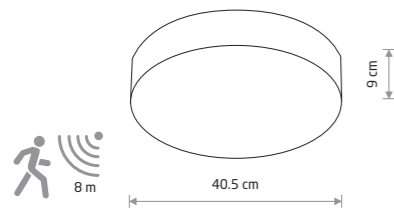

ARENA SENSOR
 painted steel, plastic PMMA
 □ 10186 ■ 10177
 3xE14, max 10W only LED

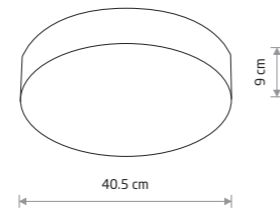

ARENA
 painted steel, plastic PMMA
 □ 10184 ■ 10175
 3xE14, max 10W only LED

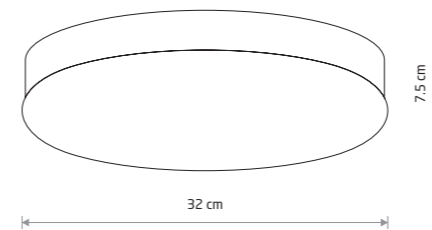

KASAI
 chrome plated steel, glass
 □ 9490
 2xE27, max 10W only LED
 brushed stainless steel, glass
 □ 9491
 2xE27, max 10W only LED
 painted steel, glass
 ■ 7952
 2xE27, max 10W only LED

Item No.	Power	Colour temp.	Luminous flux	Beam angle	Colour Rendering Index (CRI)	Input	Safety type	Power factor	Ingress protection	Lifetime
10185	20W LED	4000K	2200 lm	100°	≥ 80	~220-230 V, 50/60 Hz	⊕	>0.5	IP20	50000h
10176	20W LED	4000K	2200 lm	100°	≥ 80	~220-230 V, 50/60 Hz	⊕	>0.5	IP20	50000h

□ WHITE P004 RAL 9003 ■ BLACK P013 RAL 9005

□ WHITE ■ BLACK ▨ CHROME ▨ SATINE SILVER



SMART LED 8358



SMART LED 8358



- Możliwość wyboru temperatury barwowej światła w przedziałach 3000K - 6000K
- Włącznik dotykowy z funkcją ściemniania
- Port USB umożliwiające ładowanie telefonu

- Possibility to choose the colour temperature of light in the range from 3000K to 6000K
- Touch switch with dimming function
- USB port for charging mobile phones

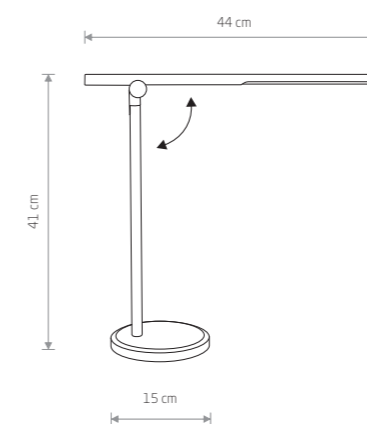

SMART LED

painted aluminum, plastic ABS

■ 8358



Item No.	Power	Colour temp.	Luminous flux	Beam angle	Colour Rendering Index (CRI)	Input	Safety type	Power factor	Ingress protection	Lifetime
8358	8W LED	CCT CHANGE 3000-6000K	400 lm	120°	≥ 80	~220-230 V, 50/60 Hz	■	>0.5	IP20	25000h

■ BLACK

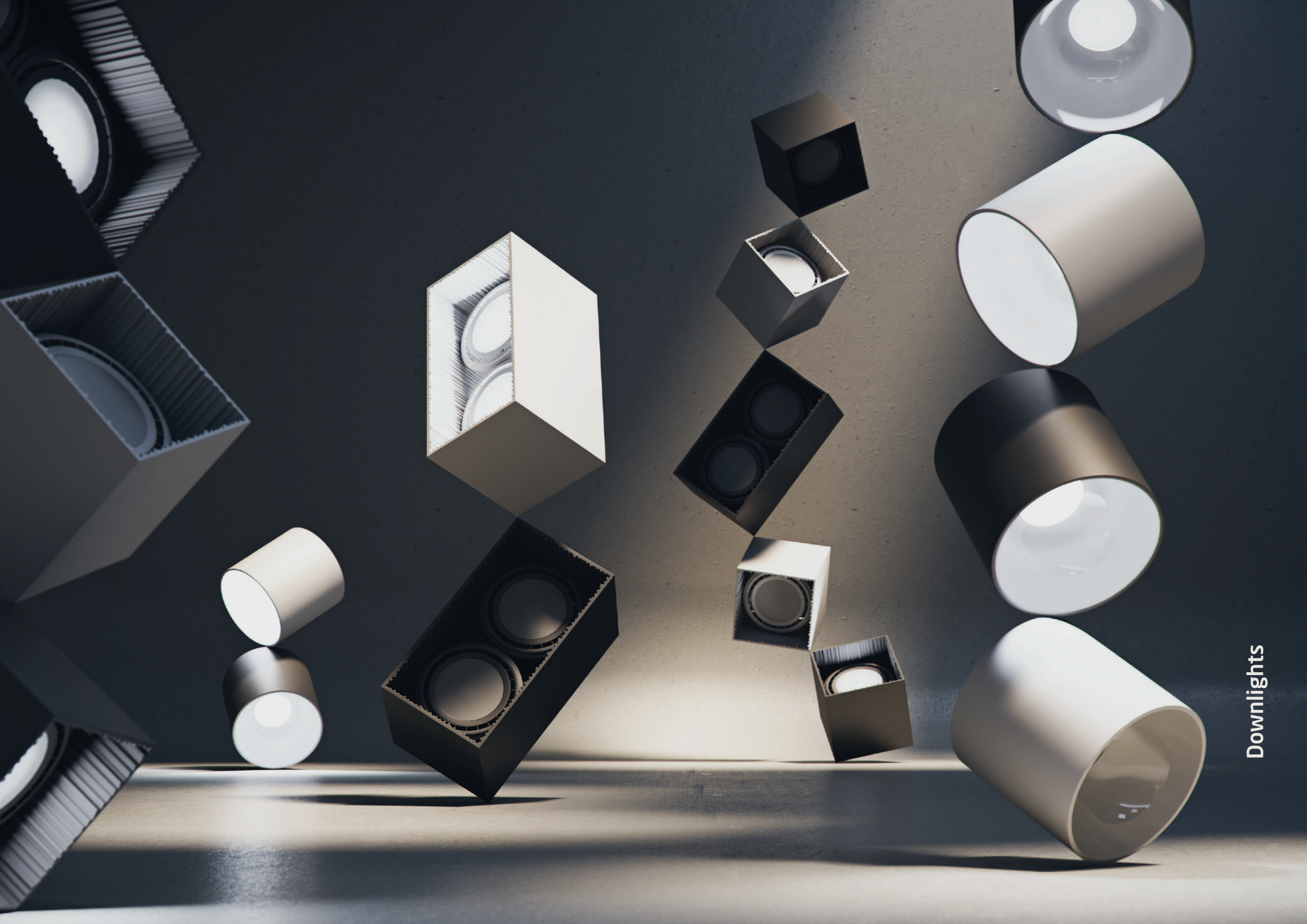

Downlights

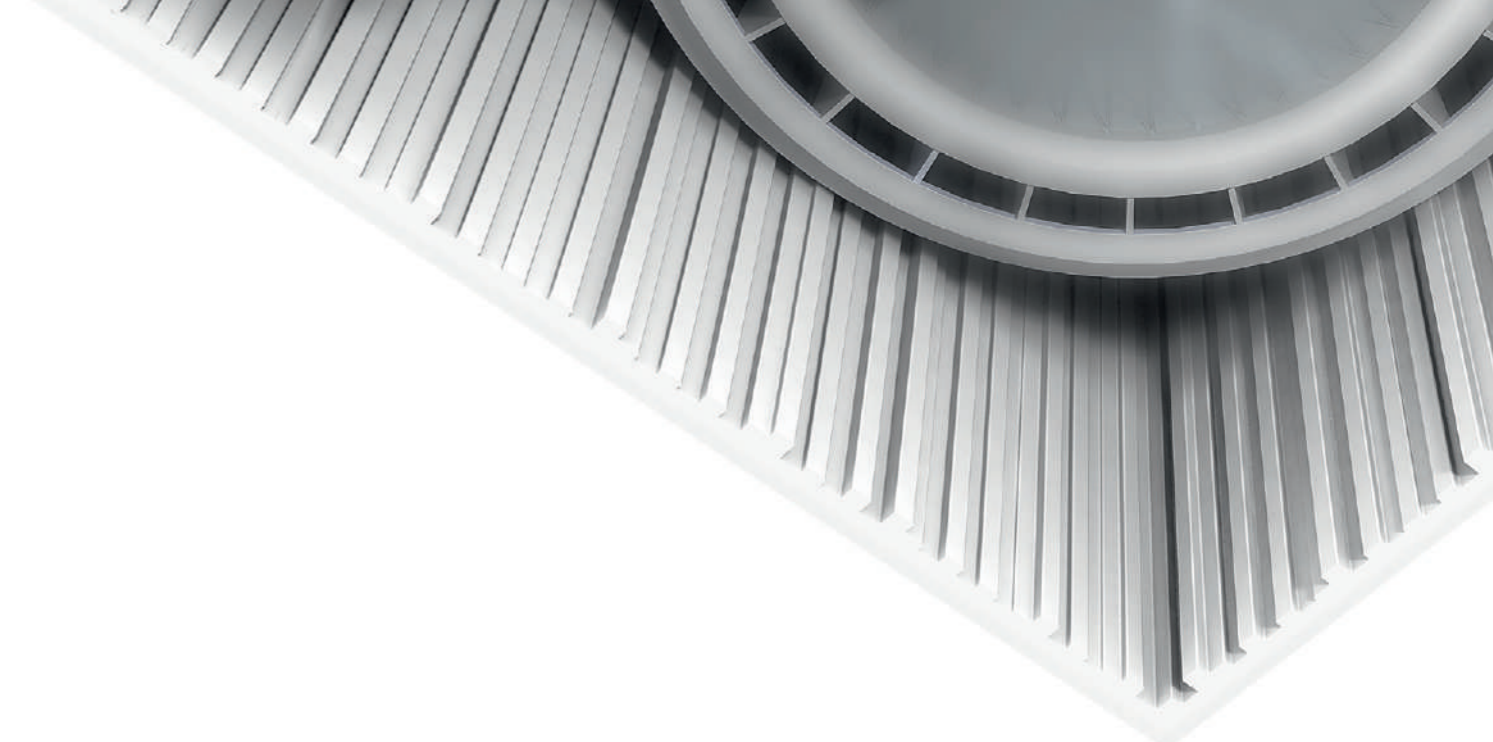

COBBLE 7791

COBBLE 7790

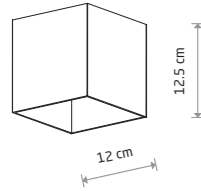
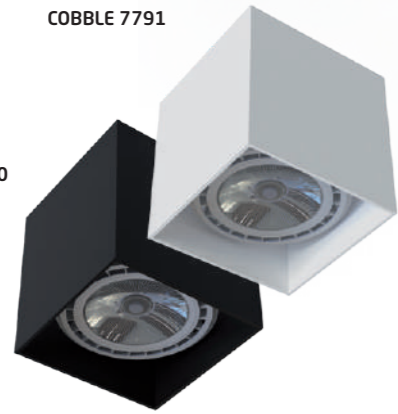

COBBLE
painted aluminum

□ 7791 ■ 7790

☐ 1xGU10 ES111, max 15W only LED

GROOVE 7793

GROOVE 7792

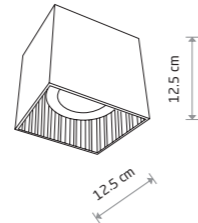

GROOVE
painted aluminum

□ 7793 ■ 7792

☐ 1xGU10 ES111, max 15W only LED

GAP 9385

GAP 9384

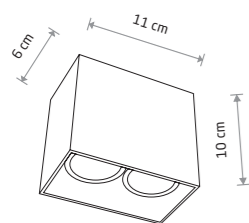

GAP
painted aluminum

□ 9385 ■ 9384

☐ 2xGU10 R50, max 10W only LED

PAG 9387

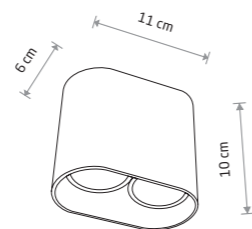

PAG
painted aluminum

□ 9387

☐ 2xGU10, max 10W only LED

GROOVE 9383



GROOVE 9316

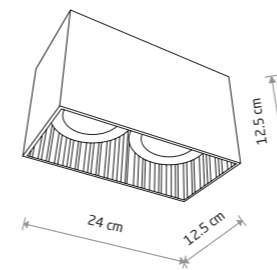

GROOVE
painted aluminum

□ 9383 ■ 9316

☐ 2xGU10 ES111, max 15W only LED

OVAL 9241



OVAL 9240

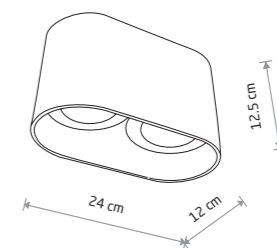

OVAL
painted aluminum

□ 9241 ■ 9240

☐ 2xGU10 ES111, max 15W only LED



MIDI LED 10048

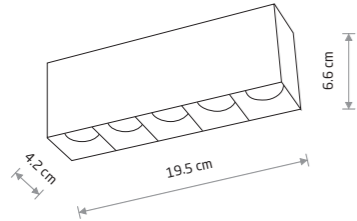

MIDI LED

painting aluminum

- 10048 3000K ■ 10052 4000K
- 10055 3000K ■ 10058 4000K



MIDI LED 10051



MIDI LED 10054

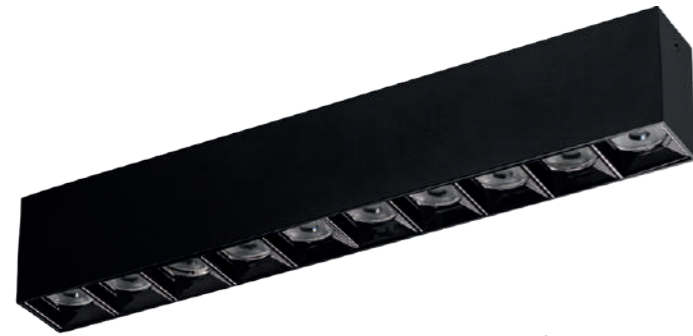

MIDI LED 10060

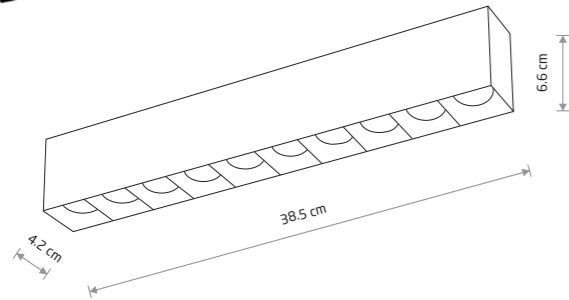

MIDI LED

painting aluminum

- 10050 3000K ■ 10053 4000K
- 10056 3000K ■ 10060 4000K

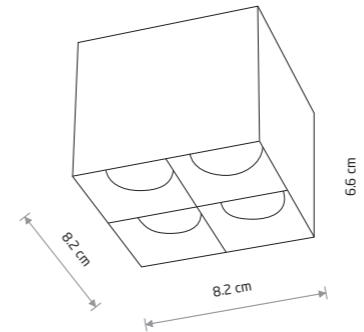

MIDI LED

painting aluminum

- 10054 3000K ■ 10057 4000K
- 10047 3000K ■ 10051 4000K



Item No.	Power	Colour temp.	Luminous flux	Beam angle	Colour Rendering Index (CRI)	Input	Safety type	Power factor	Ingress protection	Lifetime
10048	20W LED	3000K	1700 lm	36°	>90	~220-230 V, 50/60 Hz	□	>0.5	IP20	30000h
10052	20W LED	4000K	1700 lm	36°	>90	~220-230 V, 50/60 Hz	□	>0.5	IP20	30000h
10055	20W LED	3000K	1700 lm	36°	>90	~220-230 V, 50/60 Hz	□	>0.5	IP20	30000h
10050	40W LED	3000K	3500 lm	36°	>90	~220-230 V, 50/60 Hz	□	>0.9	IP20	30000h
10053	40W LED	4000K	3500 lm	36°	>90	~220-230 V, 50/60 Hz	□	>0.9	IP20	30000h
10056	40W LED	3000K	3500 lm	36°	>90	~220-230 V, 50/60 Hz	□	>0.9	IP20	30000h
10058	20W LED	4000K	1700 lm	36°	>90	~220-230 V, 50/60 Hz	□	>0.5	IP20	30000h
10060	40W LED	4000K	3500 lm	36°	>90	~220-230 V, 50/60 Hz	□	>0.9	IP20	30000h

Item No.	Power	Colour temp.	Luminous flux	Beam angle	Colour Rendering Index (CRI)	Input	Safety type	Power factor	Ingress protection	Lifetime
10047	16W LED	3000K	1500 lm	36°	>90	~220-230 V, 50/60 Hz	□	>0.5	IP20	30000h
10051	16W LED	4000K	1500 lm	36°	>90	~220-230 V, 50/60 Hz	□	>0.5	IP20	30000h
10054	16W LED	3000K	1500 lm	36°	>90	~220-230 V, 50/60 Hz	□	>0.5	IP20	30000h
10057	16W LED	4000K	1500 lm	36°	>90	~220-230 V, 50/60 Hz	□	>0.5	IP20	30000h



MIDI LED RECESSED
10064

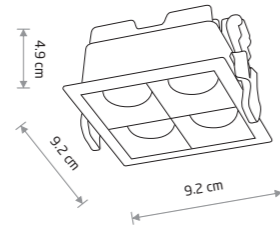

MIDI LED RECESSED

■ painted aluminum

■ 10064 4000K



✓ cut out 85×85 mm

MIDI LED RECESSED
10062

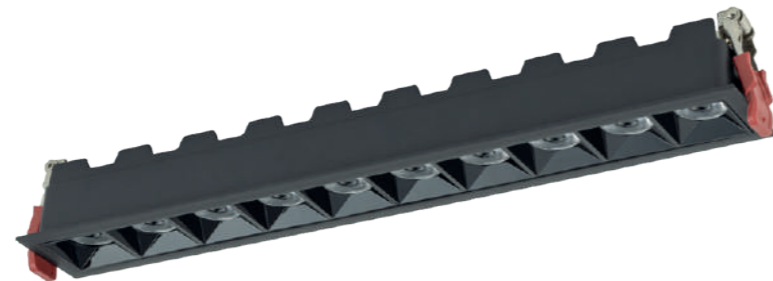

MIDI LED RECESSED
10063

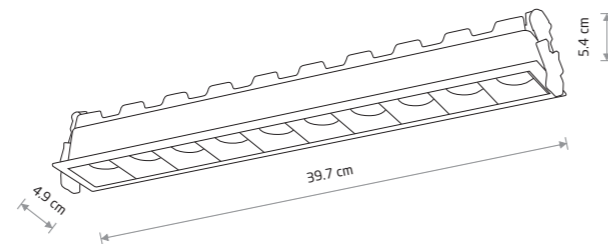
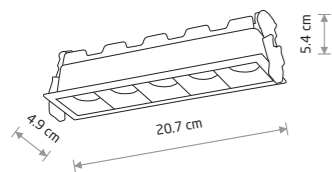

MIDI LED RECESSED

■ painted aluminum

■ 10062 3000K ■ 10065 4000K



✓ cut out 200×45 mm

MIDI LED RECESSED

■ painted aluminum

■ 10063 3000K



✓ cut out 390×45 mm

Item No.	Power	Colour temp.	Luminous flux	Beam angle	Colour Rendering Index (CRI)	Input	Safety type	Power factor	Ingress protection	Lifetime
10064	16W LED	4000K	1400 lm	36°	>90	~220-230 V, 50/60 Hz	☐	>0.5	IP20	30000h
10062	20W LED	3000K	1800 lm	36°	>90	~220-230 V, 50/60 Hz	☐	>0.5	IP20	30000h
10065	20W LED	4000K	1800 lm	36°	>90	~220-230 V, 50/60 Hz	☐	>0.5	IP20	30000h
10063	40W LED	3000K	3300 lm	36°	>90	~220-230 V, 50/60 Hz	☐	>0.9	IP20	30000h

■ BLACK





MINI LED RECESSED
10043

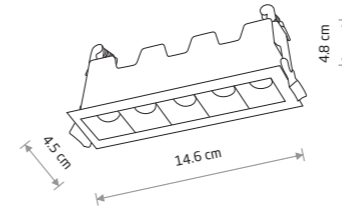

MINI LED RECESSED

painting aluminum

- 10042 3000K 10043 4000K



cut out 140x35 mm



MINI LED RECESSED
10045

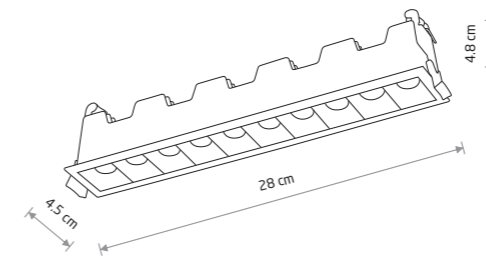

MINI LED RECESSED

painting aluminum

- 10045 3000K 10046 4000K



cut out 275x35 mm

Item No.	Power	Colour temp.	Luminous flux	Beam angle	Colour Rendering Index (CRI)	Input	Safety type	Power factor	Ingress protection	Lifetime
10042	10W LED	3000K	600 lm	30°	>90	~220-230 V, 50/60 Hz	<input checked="" type="checkbox"/>	>0.5	IP20	30000h
10043	10W LED	4000K	660 lm	30°	>90	~220-230 V, 50/60 Hz	<input checked="" type="checkbox"/>	>0.5	IP20	30000h
10045	20W LED	3000K	1220 lm	30°	>90	~220-230 V, 50/60 Hz	<input checked="" type="checkbox"/>	>0.9	IP20	30000h
10046	20W LED	4000K	1280 lm	30°	>90	~220-230 V, 50/60 Hz	<input checked="" type="checkbox"/>	>0.9	IP20	30000h

WHITE BLACK



FOCUS MINI LED
10067



FOCUS MINI LED
10071

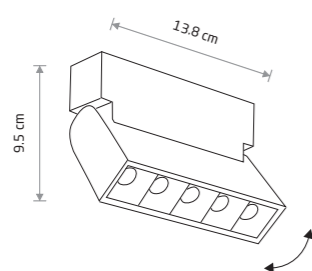

FOCUS MINI LED

painting aluminum

- 10067 3000K
 10070 4000K
- 10068 3000K
 10071 4000K



FOCUS MINI LED 10071

Item No.	Power	Colour temp.	Luminous flux	Beam angle	Colour Rendering Index (CRI)	Input	Safety type	Power factor	Ingress protection	Lifetime
10067	10W LED	3000K	600 lm	36°	>90	~220-230 V, 50/60 Hz	☐	>0.9	IP20	30000h
10070	10W LED	4000K	600 lm	36°	>90	~220-230 V, 50/60 Hz	☐	>0.9	IP20	30000h
10068	10W LED	3000K	600 lm	36°	>90	~220-230 V, 50/60 Hz	☐	>0.9	IP20	30000h
10071	10W LED	4000K	600 lm	36°	>90	~220-230 V, 50/60 Hz	☐	>0.9	IP20	30000h

WHITE
 BLACK

CL IOS LED 20W, ANGLE 60
8742



CL IOS LED 30W, ANGLE 36
8731

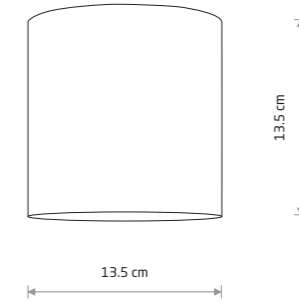

CL IOS LED 20W, ANGLE 36

zinc aluminum alloy

8740 3000K 8738 4000K

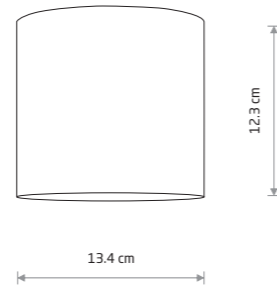

CL IOS LED 20W, ANGLE 60

zinc aluminum alloy

8742 3000K 8741 4000K

8743 4000K



CL IOS LED 40W, ANGLE 60
8724

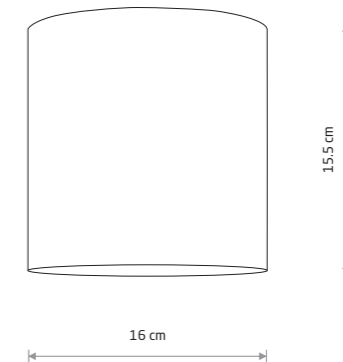

CL IOS LED 40W, ANGLE 60

zinc aluminum alloy

8724 3000K



Item No.	Power	Colour temp.	Luminous flux	Beam angle	Colour Rendering Index (CRI)	Ingress protection	LED brand	Driver brand	Lifetime	Warranty
8740	20W LED	3000K	1600 lm	36°	≥ 90	IP20	Brightlux	Osram	50000h	5 years
8738	20W LED	4000K	1600 lm	36°	≥ 90	IP20	Brightlux	Osram	50000h	5 years
8743	20W LED	4000K	1600 lm	60°	≥ 90	IP20	Brightlux	Osram	50000h	5 years
8742	20W LED	3000K	1600 lm	60°	≥ 90	IP20	Brightlux	Osram	50000h	5 years
8741	20W LED	4000K	1600 lm	60°	≥ 90	IP20	Brightlux	Osram	50000h	5 years

Item No.	Power	Colour temp.	Luminous flux	Beam angle	Colour Rendering Index (CRI)	Ingress protection	LED brand	Driver brand	Lifetime	Warranty
8731	30W LED	3000K	2700 lm	36°	≥ 90	IP20	Brightlux	Osram	50000h	5 years
8727	30W LED	4000K	2700 lm	36°	≥ 90	IP20	Brightlux	Osram	50000h	5 years
8732	30W LED	4000K	2700 lm	60°	≥ 90	IP20	Brightlux	Osram	50000h	5 years
8724	40W LED	3000K	3200 lm	60°	≥ 90	IP20	Brightlux	Osram	50000h	5 years



HALO 8196



POINT TONE 8222



INDIA 7858



FLEA 8202



HALO 8195



POINT TONE 8225



INDIA 7860



FLEA 8203

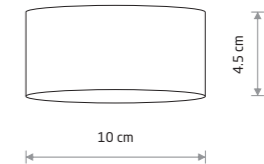
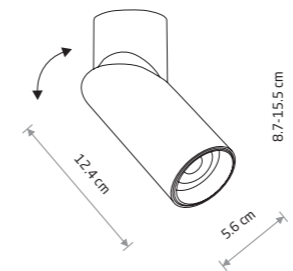
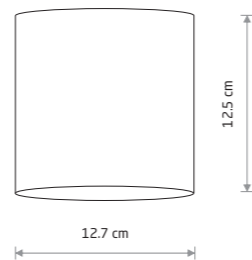
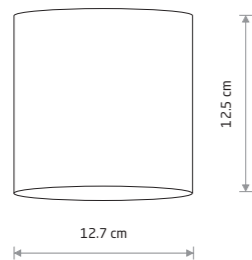

HALO

painting steel, plastic ABS

- 8195
- 8196

1xGU10 R50, max 10W only LED

POINT TONE

plastic ABS

- 8222
- 8221
- 8225
- 8224
- 8223

1xGU10 R50, max 10W only LED

INDIA

painting aluminum

- 7858
- 7860

1xGU10 R50, max 15W only LED

FLEA

painting steel

- 8202
- 8203

1xGX53, max 12W only LED



SET 8895

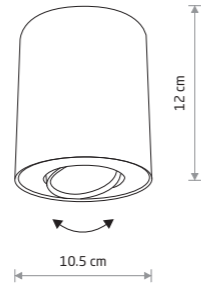

SET

painting steel

8895 8900

1xGU10 R50, max 10W only LED



EYE TONE 8932



EYE TONE 8928

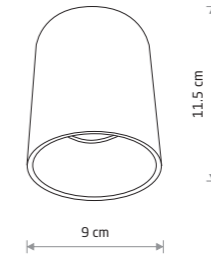

EYE TONE

painting steel, plastic ABS

8932 8928

1xGU10 R50, max 10W only LED



SET 8901

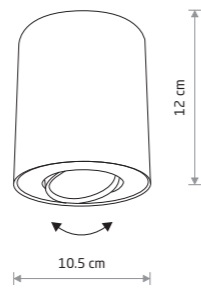

SET

painting steel

8901 8896

1xGU10 R50, max 10W only LED



EYE TONE 8931



EYE TONE 8926

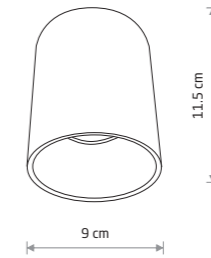

EYE TONE

painting steel, plastic ABS

8931 8926

1xGU10 R50, max 10W only LED



SET 8898

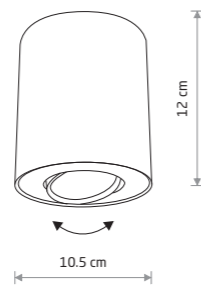

SET

painting steel

8898

1xGU10 R50, max 10W only LED



EYE TONE 8930



EYE TONE 8925

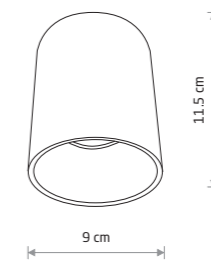

EYE TONE

painting steel, plastic ABS

8930 8925

1xGU10 R50, max 10W only LED



EYE TONE 8087

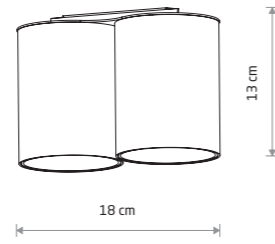

EYE TONE

painting steel, plastic ABS

8086 8087

8088 7665

2xGU10 R50, max 10W only LED



POINT PLEXI L 6528

POINT PLEXI L

painting steel, plastic PMMA

6528 6530

1xE27, max 20W



POINT PLEXI M 6526

POINT PLEXI M

painting steel, plastic PMMA

6525 6526

1xGU10 R50, max 10W only LED



EYE TONE 8092

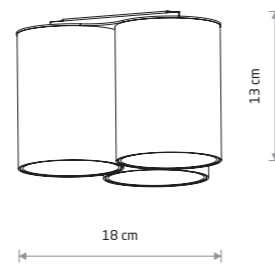

EYE TONE

painting steel, plastic ABS

8091 8092

8093 7666

3xGU10 R50, max 10W only LED



BIT S 9486

BIT S

painting steel

9482 9486

1xGU10 ES111, max 15W only LED



POINT S 7603

POINT S

painting steel

7603 6000

1xGU10 R50, max 10W only LED



SILBA 10476

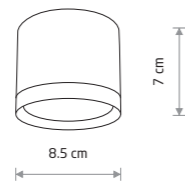

SILBA

painting aluminum

10476 10477

1xGX53, max 12W only LED

VIS

painting aluminum

10486 10485

1xGX53, max 12W only LED

cut out ø 65 mm

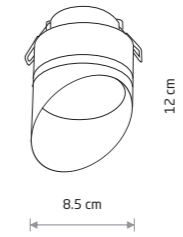

VIS 10485



CRES 10478

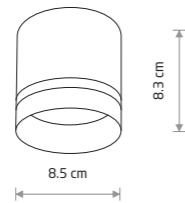

CRES

painting aluminum

10478 10480

1xGX53, max 12W only LED

HVAR

painting aluminum

10488 10487

1xGX53, max 12W only LED

cut out ø 65 mm

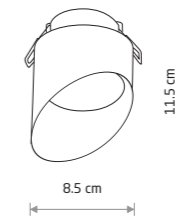

HVAR 10487



MURTER 10490

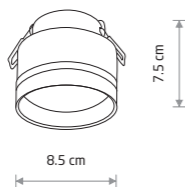

MURTER

painting aluminum

10490 10489

1xGX53, max 12W only LED

cut out ø 65 mm

SOLTA

painting aluminum

10492 10491

1xGU10 R50, max 10W only LED

cut out ø 67 mm

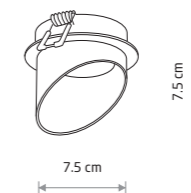

SOLTA 10491



MJET 10494

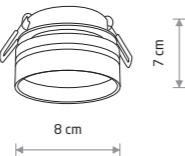

MJET

painting aluminum

10494 10493

1xGU10 R50, max 10W only LED

cut out ø 67 mm

SHINE

aluminum

11350 11348

1xGU10 R50, max 15W only LED

cut out ø 68 mm



SHINE 11348



UNO S 10841

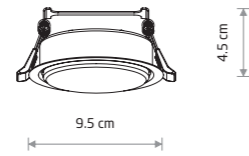

UNO S

painting steel

10840 10841

- 1xGX53, max 15 W only LED
- cut out ø 83 mm



CUP 10789

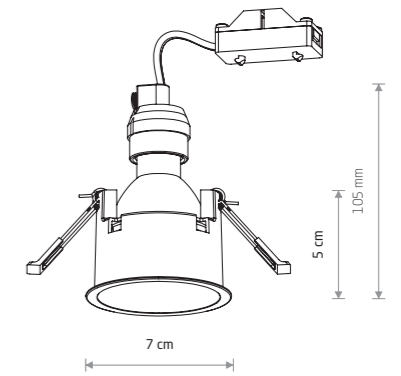

CUP

plastic ABS

10788 10789 10790
10791 10792

- 1xGU10 R50, max 10W only LED
- cut out ø 64 mm



UNO M 10843

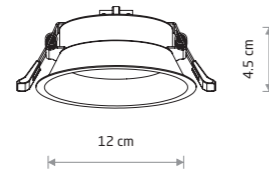

UNO M

painting steel

10842 10843

- 1xGX53, max 15 W only LED
- cut out ø 102 mm



CUP 10789



UNO L 10845

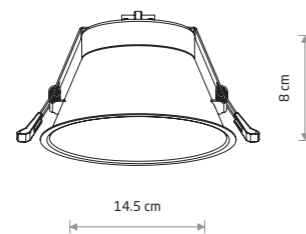

UNO L

painting steel

10844 10845

- 1xGX53, max 15 W only LED
- cut out ø 127 mm



CUP 10794

CUP 3 PC SET

plastic ABS

10793 10794

- 3xGU10 R50, max 10W only LED
- cut out ø 64 mm



MYKONOS LED 18W
10542

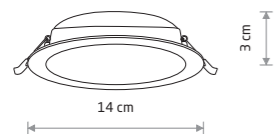

MYKONOS LED 10W

plastic

- 10537 3000K
- 10538 4000K

cut out 125 mm

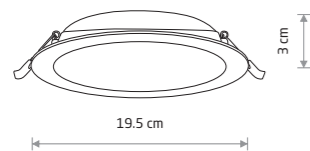

MYKONOS LED 18W

plastic

- 10542 3000K
- 10543 4000K

cut out 175 mm

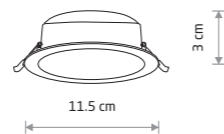

MYKONOS LED 6W

plastic

- 10535 3000K
- 10536 4000K

cut out 100 mm

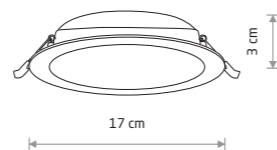

MYKONOS LED 15W

plastic

- 10540 3000K
- 10541 4000K

cut out 150 mm

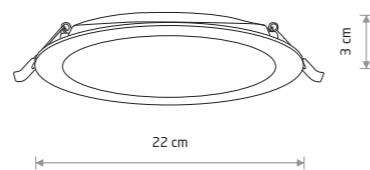

MYKONOS LED 24W

plastic

- 10544 3000K
- 10545 4000K

cut out 200 mm

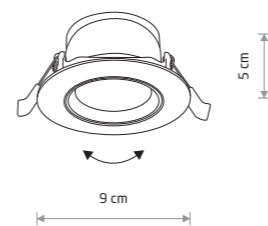

EGINA LED 5W

plastic

- 10546 3000K
- 10547 4000K

- 10548 3000K
- 10550 4000K

cut out 75 mm

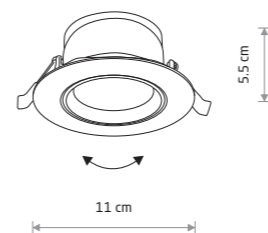

EGINA LED 10W

plastic

- 10551 3000K
- 10552 4000K

- 10553 3000K
- 10554 4000K

cut out 100 mm



EGINA LED 10W
10553

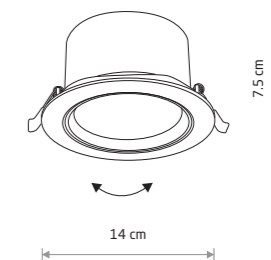

EGINA LED 15W

plastic

- 10555 3000K
- 10556 4000K

- 10557 3000K
- 10558 4000K

cut out 125 mm

Item No.	Power	Colour temp.	Luminous flux	Beam angle	Colour Rendering Index (CRI)	Input	Safety type	Power factor	Ingress protection	Lifetime
10535	6W LED	3000K	360 lm	110°	>80	~220-230 V, 50/60 Hz	□	>0.5	IP20	30000h
10536	6W LED	4000K	390 lm	110°	>80	~220-230 V, 50/60 Hz	□	>0.5	IP20	30000h
10537	10W LED	3000K	900 lm	110°	>80	~220-230 V, 50/60 Hz	□	>0.5	IP20	30000h
10538	10W LED	4000K	950 lm	110°	>80	~220-230 V, 50/60 Hz	□	>0.5	IP20	30000h
10540	15W LED	3000K	1450 lm	110°	>80	~220-230 V, 50/60 Hz	□	>0.5	IP20	30000h
10541	15W LED	4000K	1500 lm	110°	>80	~220-230 V, 50/60 Hz	□	>0.5	IP20	30000h
10542	18W LED	3000K	1700 lm	110°	>80	~220-230 V, 50/60 Hz	□	>0.5	IP20	30000h
10543	18W LED	4000K	1800 lm	110°	>80	~220-230 V, 50/60 Hz	□	>0.5	IP20	30000h
10544	24W LED	3000K	2400 lm	110°	>80	~220-230 V, 50/60 Hz	□	>0.5	IP20	30000h
10545	24W LED	4000K	2500 lm	110°	>80	~220-230 V, 50/60 Hz	□	>0.5	IP20	30000h

Item No.	Power	Colour temp.	Luminous flux	Beam angle	Colour Rendering Index (CRI)	Input	Safety type	Power factor	Ingress protection	Lifetime
10546	5W LED	3000K	350 lm	30°	>80	~220-230 V, 50/60 Hz	□	>0.5	IP20	30000h
10547	5W LED	4000K	370 lm	30°	>80	~220-230 V, 50/60 Hz	□	>0.5	IP20	30000h
10548	5W LED	3000K	330 lm	30°	>80	~220-230 V, 50/60 Hz	□	>0.5	IP20	30000h
10550	5W LED	4000K	350 lm	30°	>80	~220-230 V, 50/60 Hz	□	>0.5	IP20	30000h
10551	10W LED	3000K	700 lm	30°	>80	~220-230 V, 50/60 Hz	□	>0.5	IP20	30000h
10552	10W LED	4000K	750 lm	30°	>80	~220-230 V, 50/60 Hz	□	>0.5	IP20	30000h
10553	10W LED	3000K	650 lm	30°	>80	~220-230 V, 50/60 Hz	□	>0.5	IP20	30000h
10554	10W LED	4000K	700 lm	30°	>80	~220-230 V, 50/60 Hz	□	>0.5	IP20	30000h
10555	15W LED	3000K	1100 lm	30°	>80	~220-230 V, 50/60 Hz	□	>0.5	IP20	30000h
10556	15W LED	4000K	1200 lm	30°	>80	~220-230 V, 50/60 Hz	□	>0.5	IP20	30000h
10557	15W LED	3000K	1000 lm	30°	>80	~220-230 V, 50/60 Hz	□	>0.5	IP20	30000h
10558	15W LED	4000K	1100 lm	30°	>80	~220-230 V, 50/60 Hz	□	>0.5	IP20	30000h

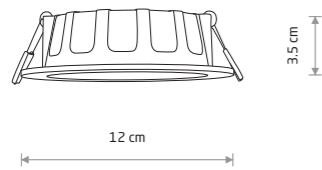

CL KOS LED 8W

plastic

8782 3000K 8781 4000K



cut out ø 100 mm

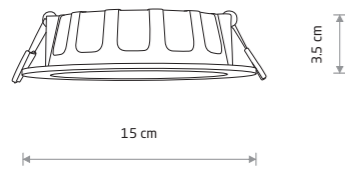

CL KOS LED 10W

plastic

8780 3000K 8778 4000K



cut out ø 125 mm

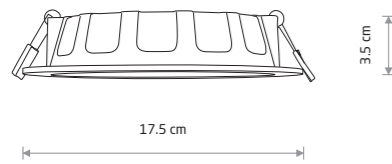

CL KOS LED 16W

plastic

8777 3000K 8776 4000K



cut out ø 150 mm

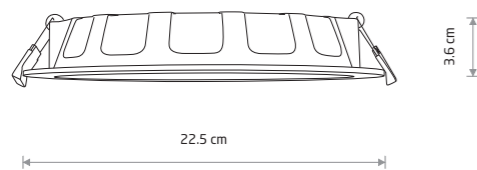

CL KOS LED 24W

plastic

8775 3000K 8774 4000K



cut out ø 200 mm



Item No.	Power	Colour temp.	Luminous flux	Beam angle	Colour Rendering Index (CRI)	Ingress protection	LED brand	Driver brand	Lifetime	Warranty
8782	8W LED	3000K	650 lm	100°	≥ 80	IP44/20	Sanan	Driver on board	50000h	5 years
8781	8W LED	4000K	670 lm	100°	≥ 80	IP44/20	Sanan	Driver on board	50000h	5 years
8780	10W LED	3000K	1000 lm	100°	≥ 80	IP44/20	Sanan	Driver on board	50000h	5 years
8778	10W LED	4000K	1100 lm	100°	≥ 80	IP44/20	Sanan	Driver on board	50000h	5 years
8777	16W LED	3000K	1500 lm	100°	≥ 80	IP44/20	Sanan	Driver on board	50000h	5 years
8776	16W LED	4000K	1600 lm	100°	≥ 80	IP44/20	Sanan	Driver on board	50000h	5 years
8775	24W LED	3000K	2300 lm	100°	≥ 80	IP44/20	Sanan	Driver on board	50000h	5 years
8774	24W LED	4000K	2600 lm	100°	≥ 80	IP44/20	Sanan	Driver on board	50000h	5 years

CL DIA LED 18W
8722

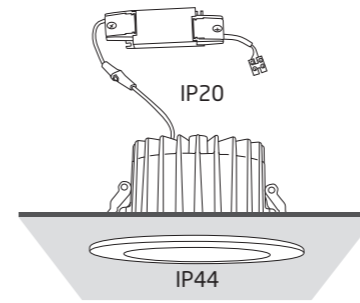

CL KEA LED 40W
8767

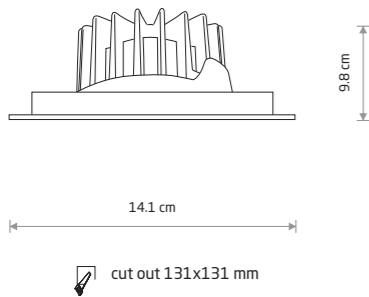

CL DIA LED 18W

zinc aluminum alloy

8722 3000K

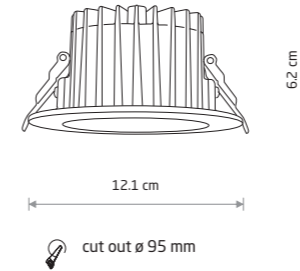

CL KEA LED 20W

plastic

8773 3000K 8772 4000K

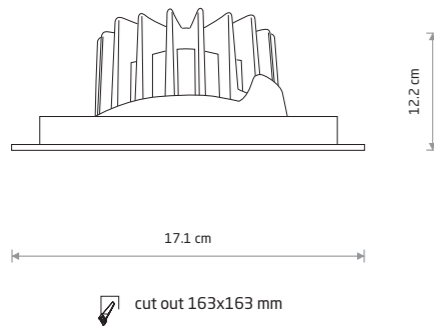

CL DIA LED 30W

zinc aluminum alloy

8720 3000K

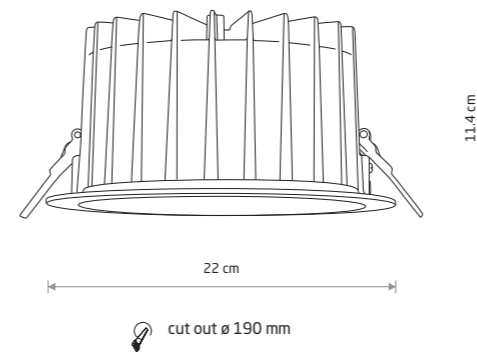

CL KEA LED 40W

plastic

8767 4000K



Item No.	Power	Colour temp.	Luminous flux	Beam angle	Colour Rendering Index (CRI)	Ingress protection	LED brand	Driver brand	Lifetime	Warranty
8720	30W LED	3000K	2250 lm	40°	≥ 90	IP20	Cree	Osram	50000h	5 years
8722	18W LED	3000K	1500 lm	40°	≥ 90	IP20	Cree	Osram	50000h	5 years

Item No.	Power	Colour temp.	Luminous flux	Beam angle	Colour Rendering Index (CRI)	Ingress protection	LED brand	Driver brand	Lifetime	Warranty
8773	20W LED	3000K	1150 lm	65°	≥ 90	IP44/20	Samsung	Osram	50000h	5 years
8772	20W LED	4000K	1150 lm	65°	≥ 90	IP44/20	Samsung	Osram	50000h	5 years
8767	40W LED	4000K	2700 lm	65°	≥ 90	IP44/20	Samsung	Osram	50000h	5 years

WHITE BLACK

Can be used in the bathroom

WHITE CHROME

MOD 9412

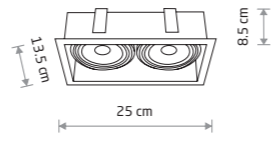
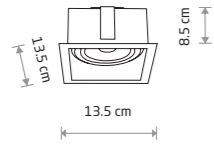

MOD

painting steel

■ 9417 □ 9413

1xGU10 ES111, max 15W only LED

cut out 120x120 mm

MOD

painting steel

■ 9416 □ 9412

2xGU10 ES111, max 15W only LED

cut out 230x120 mm

DOWNLIGHT ES111 9570

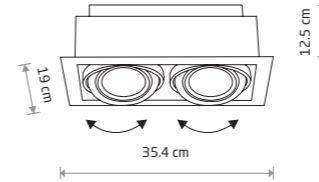

DOWNLIGHT ES111

painting steel

■ 9570 □ 9574

2xGU10 ES111, max 15W only LED

cut out 320x165 mm

MOD PLUS 9404

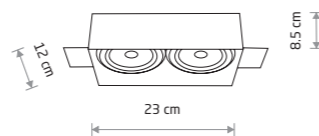
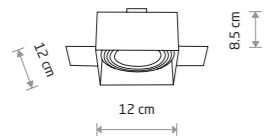

MOD PLUS

painting steel

■ 9404 □ 9408

1xGU10 ES111, max 15W only LED

cut out 120x120 mm

MOD PLUS

painting steel

■ 9403 □ 9407

2xGU10 ES111, max 15W only LED

cut out 230x120 mm

DOWNLIGHT ES111 9575

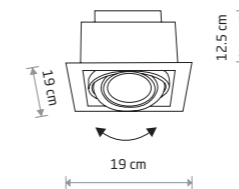

DOWNLIGHT ES111

painting steel

■ 9571 □ 9575

1xGU10 ES111, max 15W only LED

cut out 165x165 mm



EYE MOD 8937

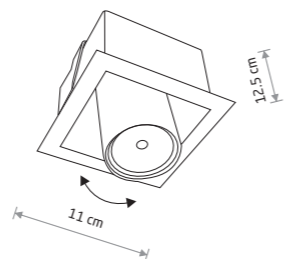

EYE MOD

■ painted steel

■ 8937

☒ 1xGU10 R50, max 10W only LED

☒ cut out 95×90 mm



EYE MOD 8938

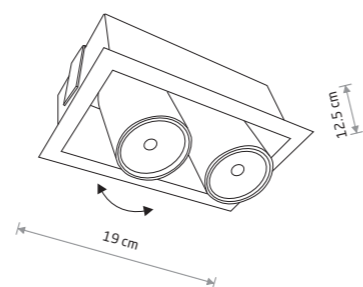

EYE MOD

■ painted steel

□ 8938 ■ 8940

☒ 2xGU10 R50, max 10W only LED

☒ cut out 175×90 mm

DOT 9378



DOT 9378

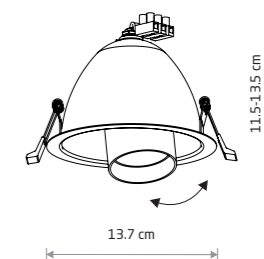

DOT

■ painted steel

□ 9378 ■ 8826

☒ 1xGU10 R50, max 10W only LED

☒ cut out ø 129 mm



Track Light Systems

TRACK LIGHT SYSTEMS

NANO LVM LOW VOLTAGE MAGNETIC TRACK LIGHT SYSTEM 24V

ULTRA THIN LVM LOW VOLTAGE MAGNETIC TRACK LIGHT SYSTEM 48V

LVM LOW VOLTAGE MAGNETIC TRACK LIGHT SYSTEM 48V

CTLS COMMERCIAL TRACK LIGHT SYSTEM

PROFILE TRACK LIGHT SYSTEM

Sposoby montażu
Installation methods

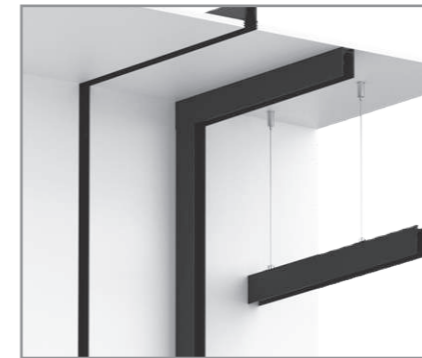

System szynoprzewodowy
Track light system

1 obwodowy system szynoprzewodowy
1 circuit track light system

1 obwodowy system szynoprzewodowy
1 circuit track light system

1 obwodowy system szynoprzewodowy
1 circuit track light system

3 obwodowy system szynoprzewodowy
3 circuits track light system

1 obwodowy system szynoprzewodowy
1 circuit track light system

Zastosowanie
Work position

Sufit / Ceiling

- Natynkowy / Surface
- Podtynkowy / Recessed
- Wiszący / Hanging

Ściana / Wall

- Natynkowy / Surface
- Podtynkowy / Recessed

Sufit / Ceiling

- Natynkowy / Surface

Ściana / Wall

- Natynkowy / Surface

Sufit / Ceiling

- Natynkowy / Surface
- Podtynkowy / Recessed
- Wiszący / Hanging

Ściana / Wall

- Natynkowy / Surface
- Podtynkowy / Recessed

Sufit / Ceiling

- Natynkowy / Surface
- Podtynkowy / Recessed
- Wiszący / Hanging

Sufit / Ceiling

- Natynkowy / Surface
- Podtynkowy / Recessed
- Wiszący / Hanging

Źródło światła
Source of light

Zintegrowane źródło światła
LED integrated

Zintegrowane źródło światła
LED integrated

Zintegrowane źródło światła
LED integrated

- Wymienne źródło światła,
- zintegrowane źródło światła
- Exchangable source of light,
- LED integrated

- Wymienne źródło światła,
- zintegrowane źródło światła
- Exchangable source of light,
- LED integrated

Napięcie
Voltage

--- 24V

--- 48V

--- 48V

~ 230V

~ 230V

Zastosuj z Cameleon System
Works with Cameleon System

No

No

No

Yes

Yes



NANO LVM Track Light System 24V

Visualisation by Iwona Ligęza

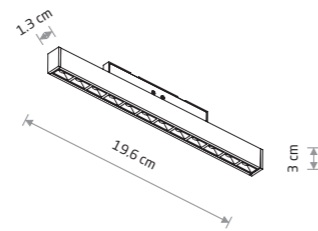

NANO - LVM FOCUS OUT LED 10W

■ painted aluminum, plastic

■ 11720

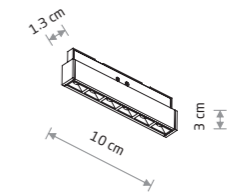

NANO - LVM FOCUS OUT LED 5W

■ painted aluminum, plastic

■ 11718



Item No.	Power	Colour temp.	Luminous flux	Beam angle	Colour Rendering Index (CRI)	Voltage DC	Safety type	Ingress protection	Lifetime
11720	10W LED	3000K	450 lm	24°	>90	24V	⚡	IP20	30000h

Item No.	Power	Colour temp.	Luminous flux	Beam angle	Colour Rendering Index (CRI)	Voltage DC	Safety type	Ingress protection	Lifetime
11718	5W LED	3000K	290 lm	24°	>90	24V	⚡	IP20	30000h



NANO - LVM LINE OUT LED 20W 11721



NANO - LVM LINE OUT LED 10W 11743

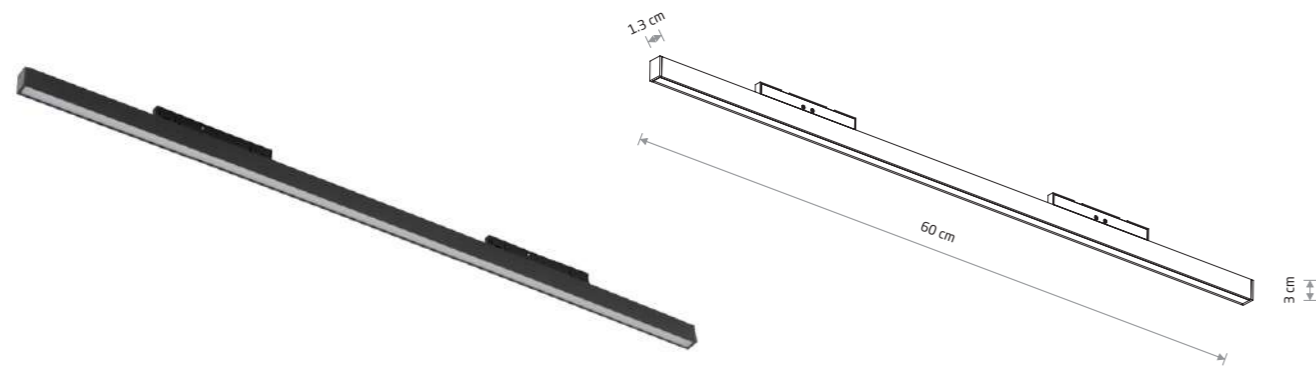

NANO - LVM LINE OUT LED 20W

painting aluminum, plastic

■ 11721

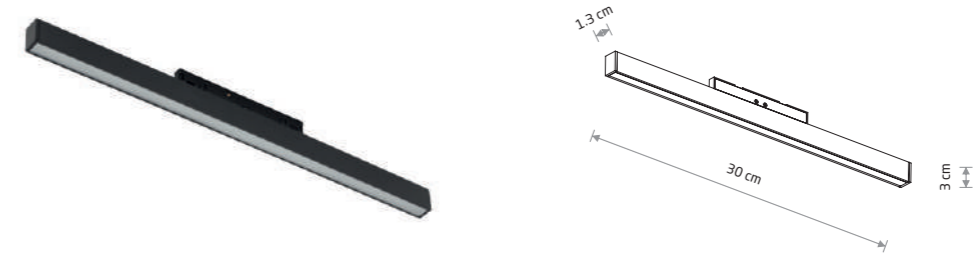

NANO - LVM LINE OUT LED 10W

painting aluminum, plastic

■ 11743



Item No.	Power	Colour temp.	Luminous flux	Beam angle	Colour Rendering Index (CRI)	Voltage DC	Safety type	Ingress protection	Lifetime
11721	20W LED	3000K	610 lm	100°	>90	24V	⚡	IP20	30000h

Item No.	Power	Colour temp.	Luminous flux	Beam angle	Colour Rendering Index (CRI)	Voltage DC	Safety type	Ingress protection	Lifetime
11743	10W LED	3000K	400 lm	100°	>90	24V	⚡	IP20	30000h

■ BLACK

■ BLACK



NANO - LVM LINE IN LED 6W 11717



NANO - LVM LINE OUT LED 6W 11723

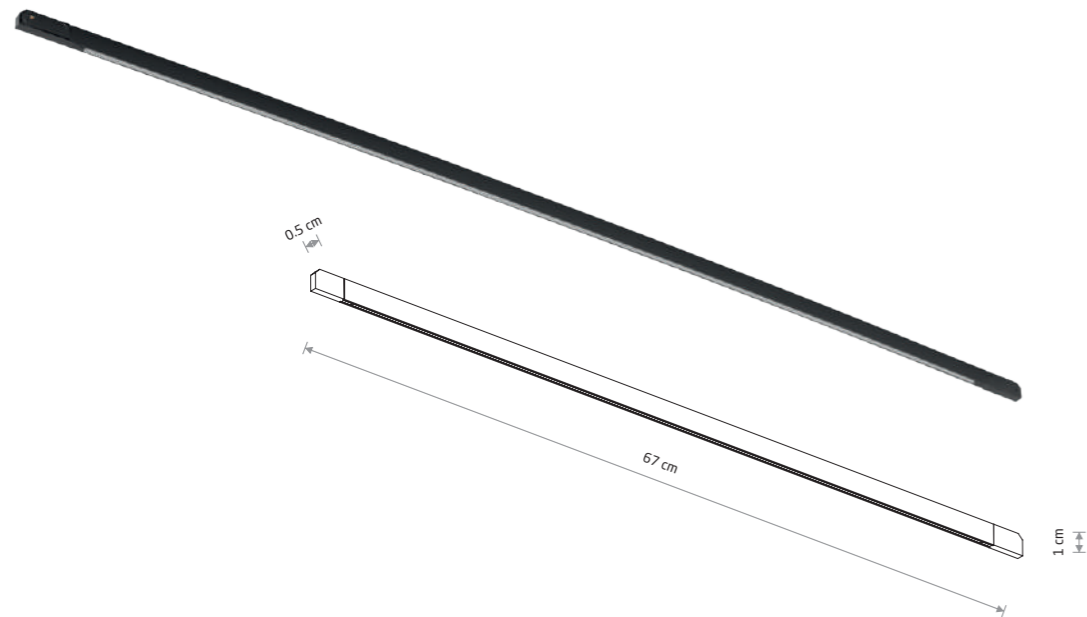

NANO - LVM LINE IN LED 6W

■ painted aluminum, plastic

■ 11717

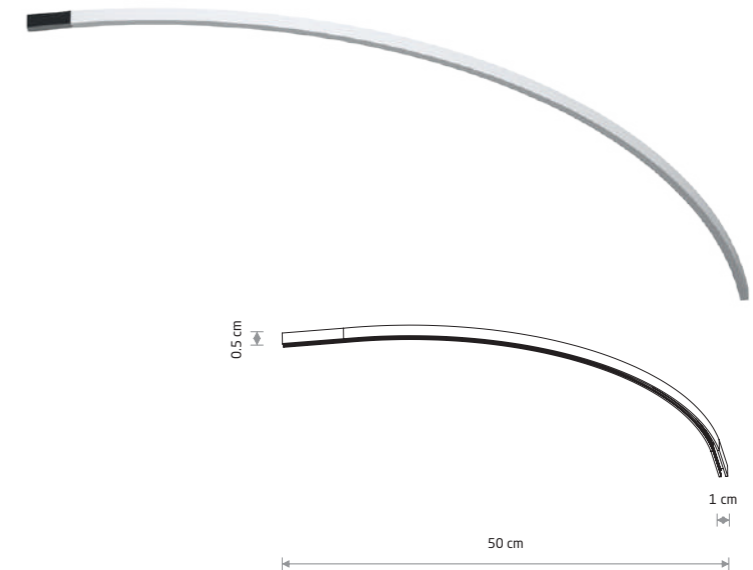

NANO - LVM FLEX LINE LED 6W

■ silicone, plastic

■ 11723



Item No.	Power	Colour temp.	Luminous flux	Beam angle	Colour Rendering Index (CRI)	Voltage DC	Safety type	Ingress protection	Lifetime
11717	6W LED	3000K	100 lm	100°	>90	24V	⚡	IP20	30000h

Item No.	Power	Colour temp.	Luminous flux	Beam angle	Colour Rendering Index (CRI)	Voltage DC	Safety type	Ingress protection	Lifetime
11723	6W LED	3000K	180 lm	100°	>90	24V	⚡	IP20	30000h



NANO - LVM SPOT LED 1W 11712



NANO - LVM MUG LED 7W 11722

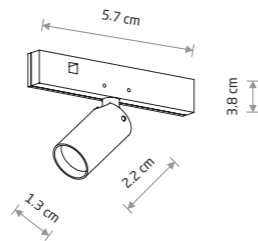
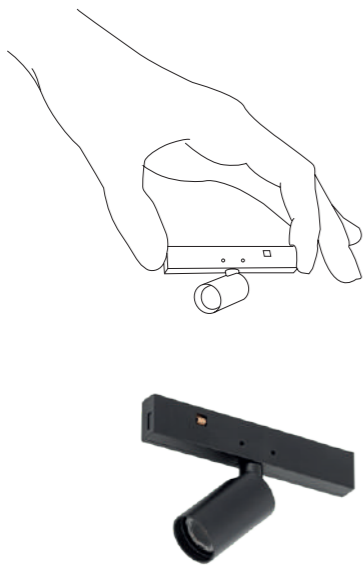

NANO - LVM SPOT LED 1W

■ painted aluminum, plastic

■ 11712

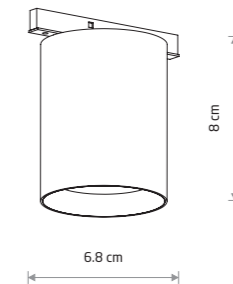

NANO - LVM MUG LED 7W

■ painted aluminum, plastic

■ 11722



Item No.	Power	Colour temp.	Luminous flux	Beam angle	Colour Rendering Index (CRI)	Voltage DC	Safety type	Ingress protection	Lifetime
11712	1W LED	3000K	65 lm	38°	>90	24V	⚡	IP20	30000h

■ BLACK

Item No.	Power	Colour temp.	Luminous flux	Beam angle	Colour Rendering Index (CRI)	Voltage DC	Safety type	Ingress protection	Lifetime
11722	7W LED	3000K	460 lm	24°	>90	24V	⚡	IP20	30000h

■ BLACK

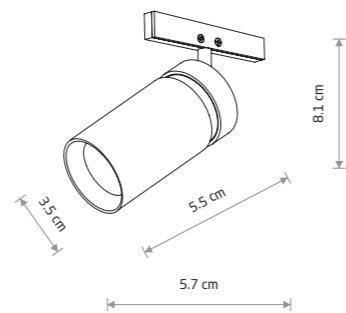
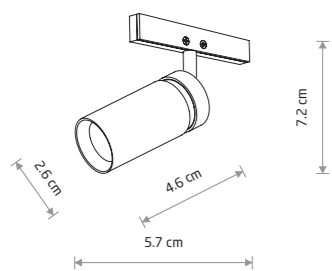

NANO - LVM SPOT ZOOM LED 2W

■ painted aluminum, plastic

■ 11713



NANO - LVM SPOT ZOOM LED 5W

■ painted aluminum, plastic

■ 11714

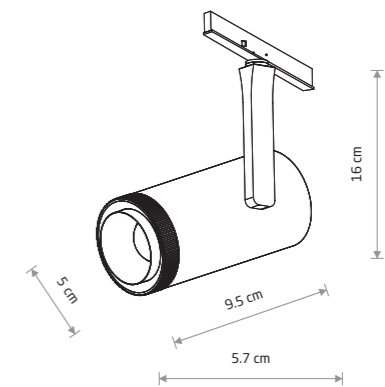
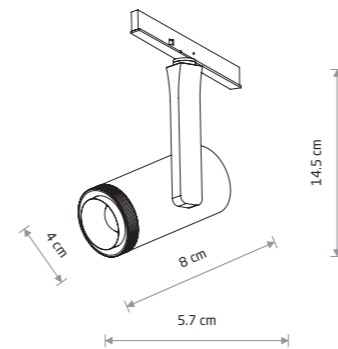

NANO - LVM SPOT ZOOM LED 7W

■ painted aluminum, plastic

■ 11715



NANO - LVM SPOT ZOOM LED 15W

■ painted aluminum, plastic

■ 11716



Item No.	Power	Colour temp.	Luminous flux	Beam angle	Colour Rendering Index (CRI)	Voltage DC	Safety type	Ingress protection	Lifetime
11713	2W LED	3000K	120 lm	15-45°	>90	24V	⚡	IP20	30000h
11714	5W LED	3000K	290 lm	15-45°	>90	24V	⚡	IP20	30000h

Item No.	Power	Colour temp.	Luminous flux	Beam angle	Colour Rendering Index (CRI)	Voltage DC	Safety type	Ingress protection	Lifetime
11715	7W LED	3000K	300 lm	15-45°	>90	24V	⚡	IP20	30000h
11716	15W LED	3000K	500 lm	15-45°	>90	24V	⚡	IP20	30000h

SPOSOBY MONTAŽU / INSTALLATION METHODS

1



SURFACE CONNECTION

2



RECESSED CONNECTION

3



SURFACE CONNECTION

4



SURFACE CONNECTION

5



RECESSED CONNECTION

6



SURFACE CONNECTION

7



RECESSED CONNECTION

8



SUSPENDED CONNECTION

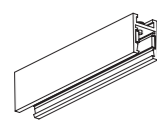

NANO - LVM TRACK

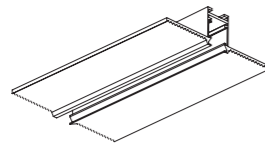

NANO - LVM RECESSED TRACK

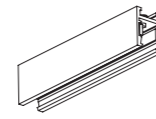

NANO - LVM TRACK

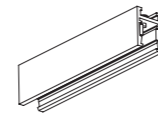

NANO - LVM TRACK

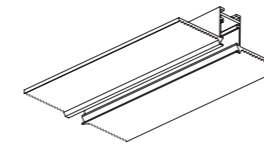

NANO - LVM RECESSED TRACK

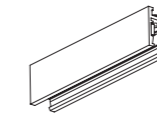

NANO - LVM TRACK

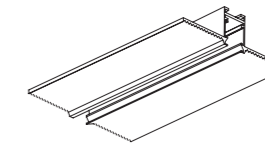

NANO - LVM RECESSED TRACK

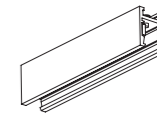

NANO - LVM TRACK

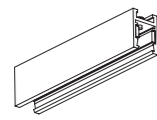

NANO - LVM TRACK

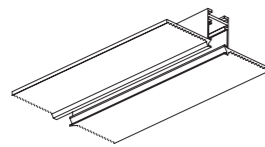

NANO - LVM RECESSED TRACK

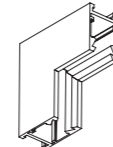

NANO - LVM INSIDE CORNER

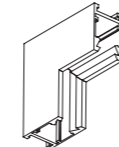

NANO - LVM INSIDE CORNER

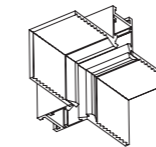

NANO - LVM RECESSED INSIDE CORNER

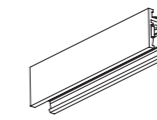

NANO - LVM TRACK

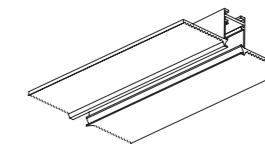

NANO - LVM RECESSED TRACK



NANO - LVM SUSPENSION KIT

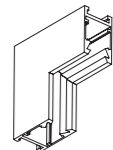

NANO - LVM INSIDE CORNER

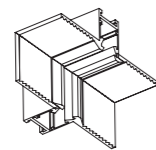

NANO - LVM RECESSED INSIDE CORNER

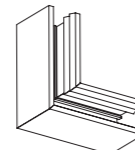

NANO - LVM HORIZONTAL CORNER



NANO - LVM CURVE TRACK R460

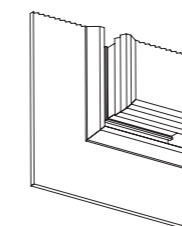

NANO - LVM RECESSED HORIZONTAL CORNER

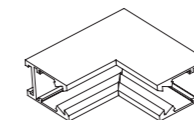

NANO - LVM INSIDE CORNER

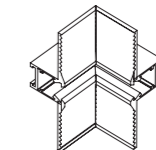

NANO - LVM RECESSED INSIDE CORNER



NANO - LVM OUTSIDE POWER SUPPLY CONDUCTIVE MODULE FOR SUSPENSION TRACK

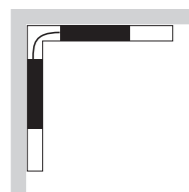

ELECTRICAL CONNECTION NANO - LVM CORNER CONDUCTIVE MODULE

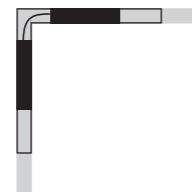

ELECTRICAL CONNECTION NANO - LVM CORNER CONDUCTIVE MODULE

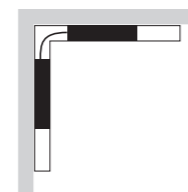

ELECTRICAL CONNECTION NANO - LVM CORNER CONDUCTIVE MODULE

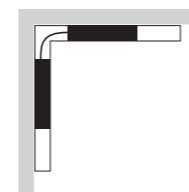

ELECTRICAL CONNECTION NANO - LVM CORNER CONDUCTIVE MODULE

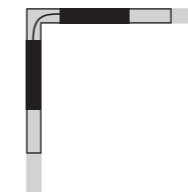

ELECTRICAL CONNECTION NANO - LVM CORNER CONDUCTIVE MODULE

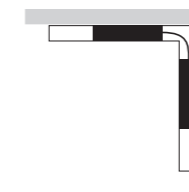

ELECTRICAL CONNECTION NANO - LVM CORNER CONDUCTIVE MODULE



ELECTRICAL CONNECTION NANO - LVM CORNER CONDUCTIVE MODULE



NANO LVM - LOW VOLTAGE MAGNETIC TRACK LIGHT SYSTEM 24V

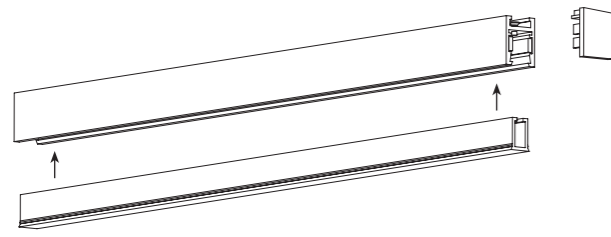

Zestaw zawiera listwę maskującą i 2 zatyczki
Set includes a masking strip and 2 plugs



- 1** NANO - LVM TRACK 1M
aluminum
■ 11724
- 2** NANO - LVM TRACK 2M
aluminum
■ 11725
- 3** NANO - LVM CURVE TRACK R460
aluminum
■ 11737

Schemat zasilania / Power supply circuit diagram

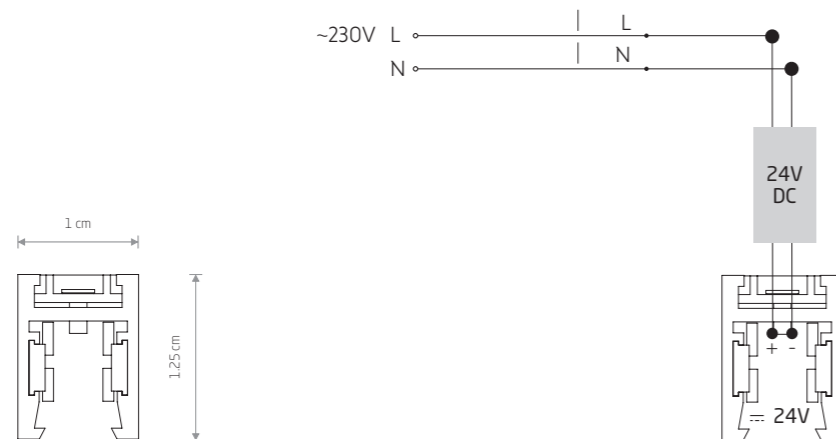

System szynoprzewodowy (NANO LVM) należy równomiernie obciążyć elektrycznie oraz równomiernie rozmieścić oprawy na jego długości.
Zalecany dystans pomiędzy mocowaniami max. 1000 mm.
Maksymalna długość systemu szynoprzewodowego z jednego źródła zasilania - 5 m.

The track light system (NANO LVM) should be evenly electrically loaded and the fittings should be evenly placed along its length.
The recommended fastening distance is max. 1000 mm.
Maximum length of track light system with a single power source is 5 m.

Sposób montażu / Installation methods

- 1. Zwieszenie na linkach
1. Suspended on steel wires



- 4** NANO - LVM OUTSIDE POWER SUPPLY CONDUCTIVE MODULE FOR SUSPENSION TRACK
painted steel, plastic
■ 11740
- 5** NANO - LVM RECESSED OUTSIDE POWER SUPPLY CONDUCTIVE MODULE FOR SUSPENSION TRACK
plastic
■ 11738
- 6** NANO - LVM SUSPENSION KIT
steel
■ 11744

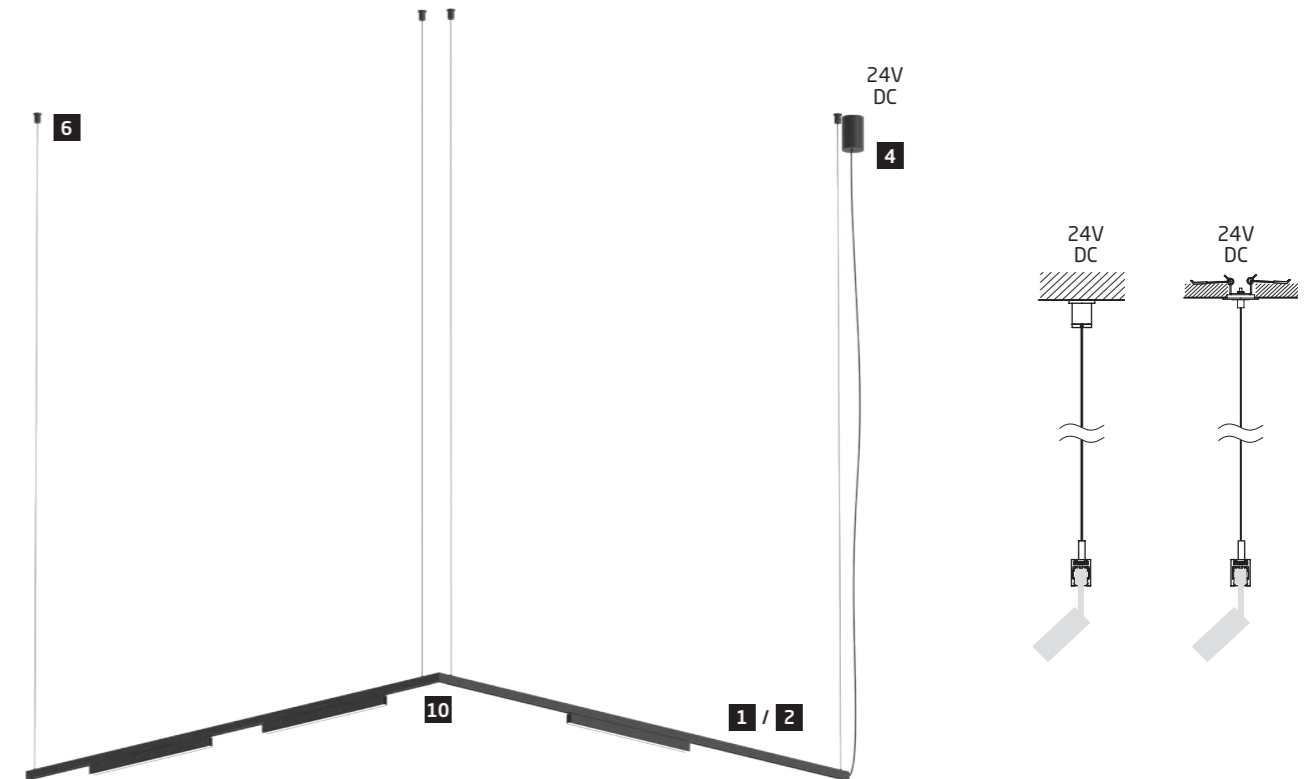

Sposób montażu / Installation method

2. Montaż bezpośredni 2. Surface mounting

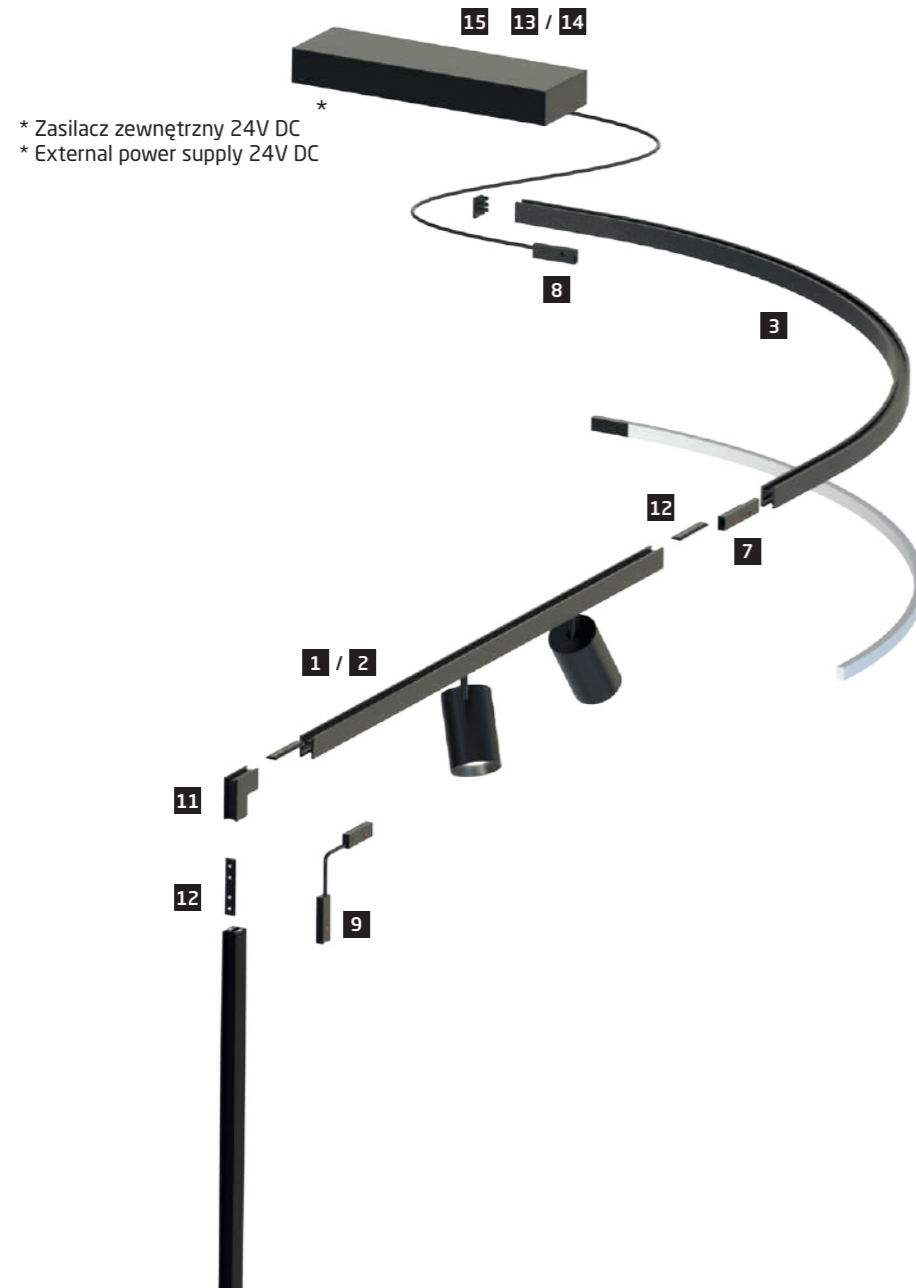

* Zasilacz zewnętrzny 24V DC
* External power supply 24V DC

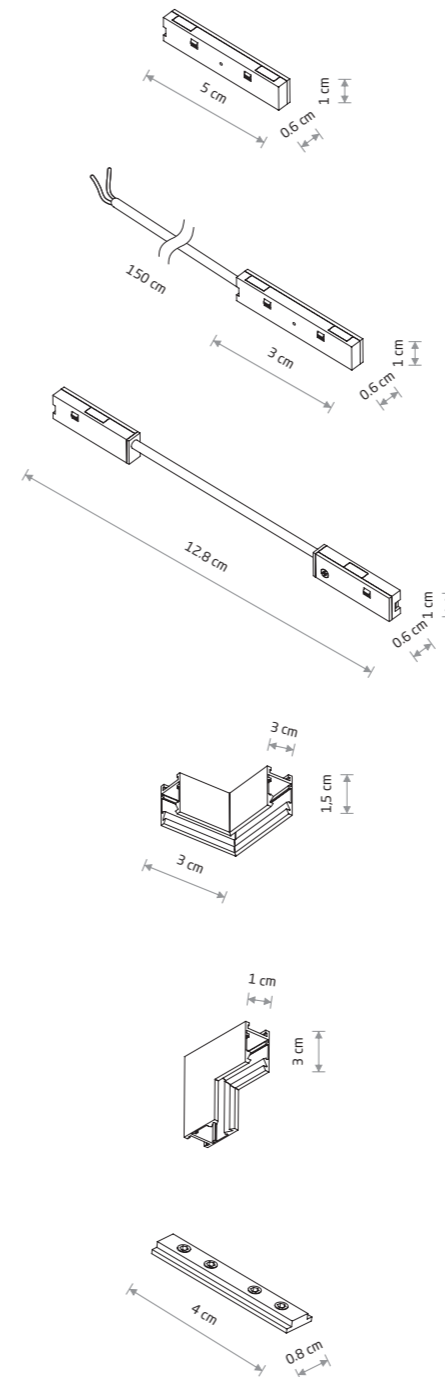
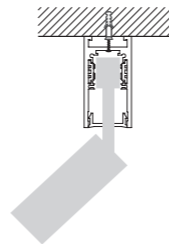

7 NANO - LVM STRAIGHT CONDUCTIVE MODULE

plastic

■ 11734

8 NANO - LVM OUTSIDE POWER SUPPLY CONDUCTIVE MODULE

plastic

■ 11736

9 NANO - LVM CORNER CONDUCTIVE MODULE

plastic

■ 11735

10 NANO - LVM HORIZONTAL CORNER

aluminum

■ 11727

11 NANO - LVM INSIDE CORNER

aluminum

■ 11728

12 NANO - LVM TRACK BUCKLE CONNECTOR

aluminum

■ 11726

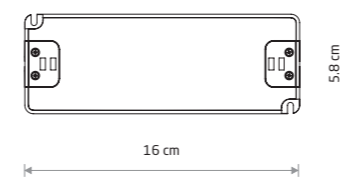

13 24V DC, 75W, POWER SUPPLY

plastic

■ 11875

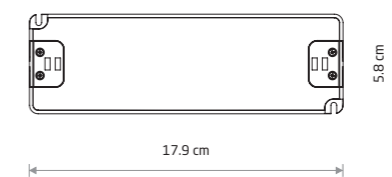

14 24V DC, 150W, POWER SUPPLY

plastic

■ 11874

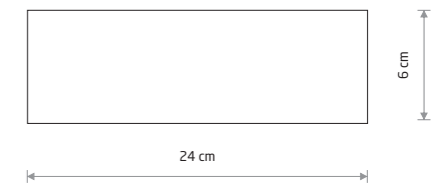

15 POWER SUPPLY COVER

painted steel

■ 11893 □ 11894

* Konieczność zastosowania zasilacza zewnętrznego 24V DC.
Zaleca się aby suma watażu użytych opraw nie przekraczała 90% mocy znamionowej zasilacza.
* Need for of using an external 24V DC power supply.
It is recommended that the total wattage of the luminaires used does not exceed 90% of the power supply's rated power.

NANO LVM - RECESSED LOW VOLTAGE MAGNETIC TRACK LIGHT SYSTEM 24V

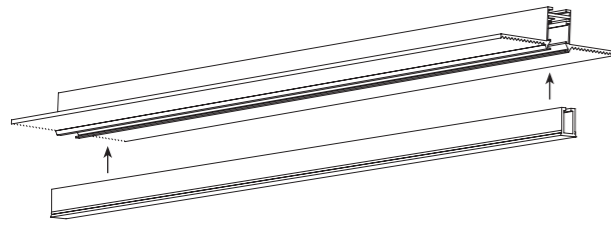

Zestaw zawiera listwę maskującą i 2 zatyczki
Set includes a masking strip and 2 plugs

- 1** NANO - LVM RECESSED TRACK 1M
aluminum
■ 11730

- 2** NANO - LVM RECESSED TRACK 2M
aluminum
■ 11731

Schemat zasilania / Power supply circuit diagram

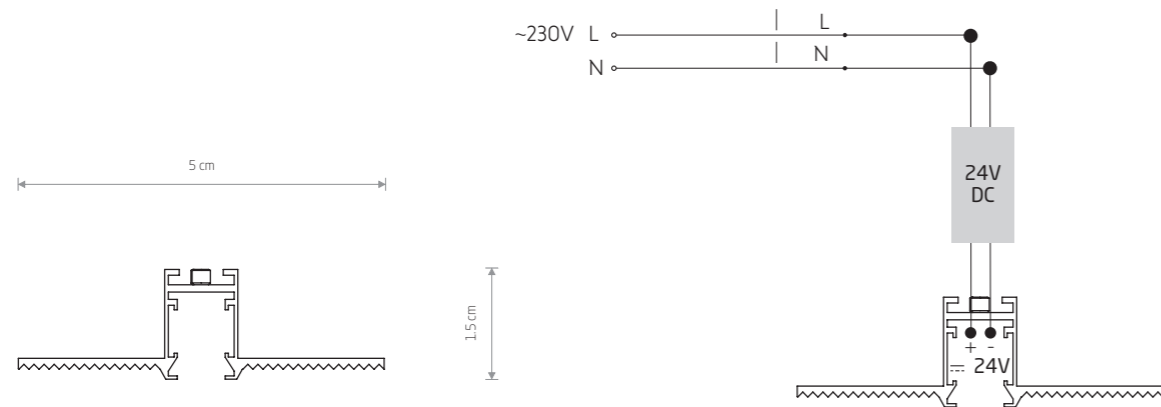

System szynoprzewodowy (NANO LVM) należy równomiernie obciążyć elektrycznie oraz równomiernie rozmieścić oprawy na jego długości.
Zalecany dystans pomiędzy mocowaniami 1000 mm.
Maksymalna długość systemu szynoprzewodowego z jednego źródła zasilania - 5 m.

The track light system (NANO LVM) should be evenly electrically loaded and the fittings should be evenly placed along its length.
The recommended fastening distance is 1000 mm.
Maximum length of track light system with a single power source is 5 m.

Sposób montażu / Installation method

1. Montaż podtynkowy
1. Recessed mounting

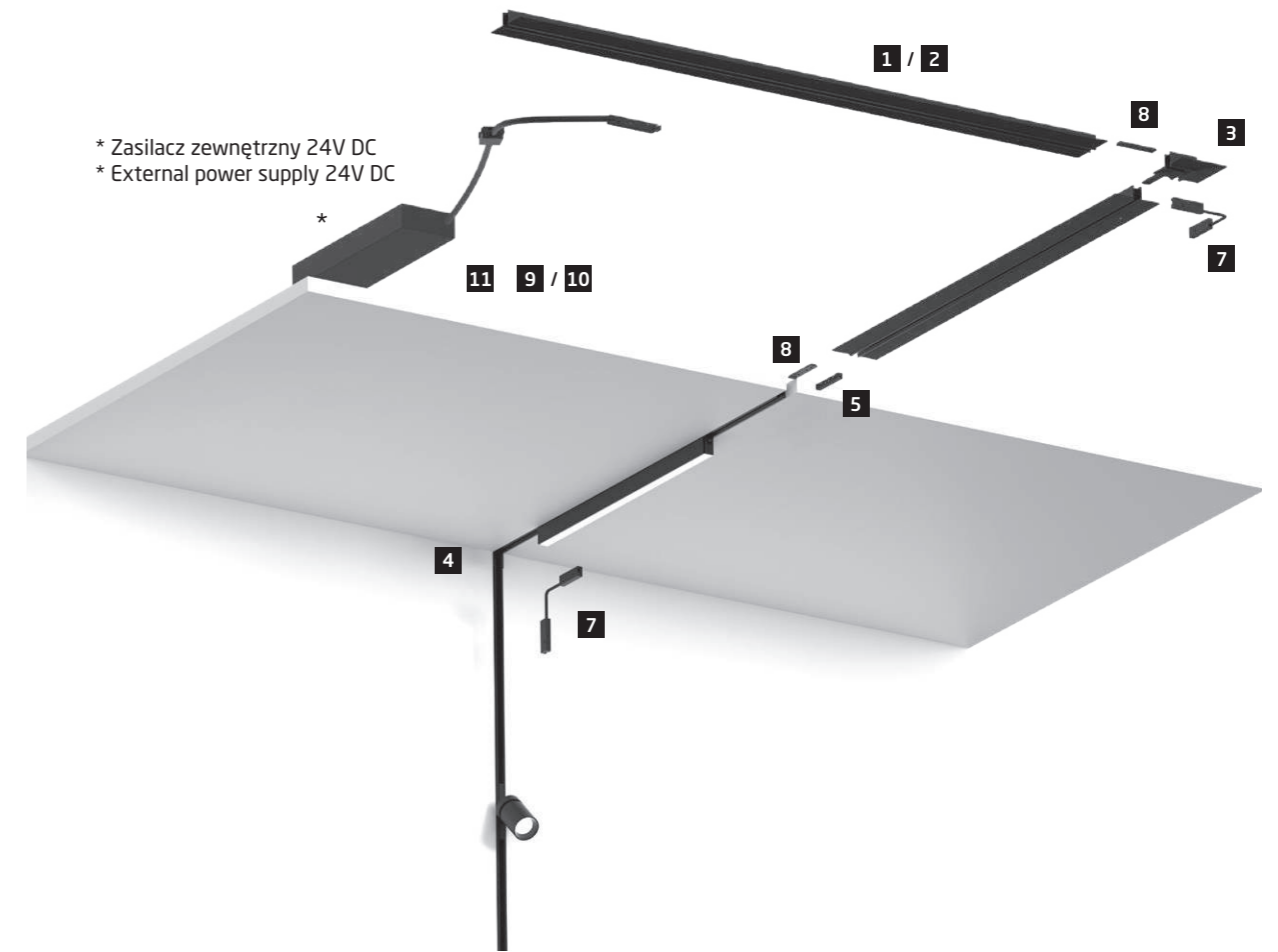

* Zasilacz zewnętrzny 24V DC
* External power supply 24V DC

- * Konieczność zastosowania zasilacza zewnętrznego 24V DC.
Zaleca się aby suma watażu użytych opraw nie przekraczała 90% mocy znamionowej zasilacza.
* Need for of using an external 24V DC power supply.
It is recommended that the total wattage of the luminaires used does not exceed 90% of the power supply's rated power.

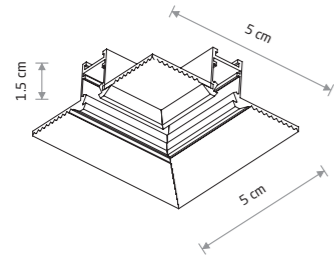

3 NANO - LVM RECESSED HORIZONTAL CORNER

aluminum

■ 11732

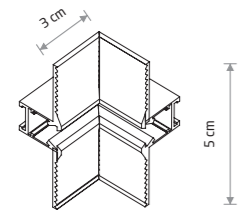

4 NANO - LVM RECESSED INSIDE CORNER

aluminum

■ 11733

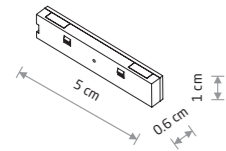

5 NANO - LVM STRAIGHT CONDUCTIVE MODULE

plastic

■ 11734

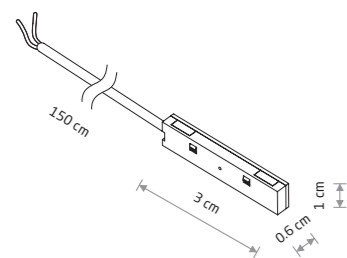

6 NANO - LVM OUTSIDE POWER SUPPLY CONDUCTIVE MODULE

plastic

■ 11736

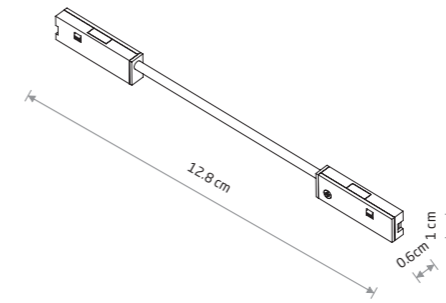

7 NANO - LVM CORNER CONDUCTIVE MODULE

plastic

■ 11735

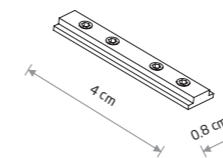

8 NANO - LVM TRACK BUCKLE CONNECTOR

aluminum

■ 11726

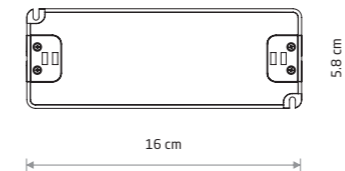

9 24V DC, 75W, POWER SUPPLY

plastic

11875

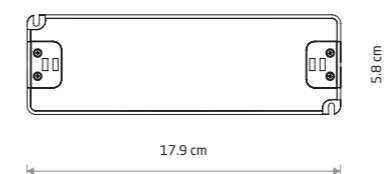

10 24V DC, 150W, POWER SUPPLY

plastic

11874



UT-LVM Track Light System 48V

Visualisation by Iwona Ligeza



UT-LVM FOCUS LED 18W 11306



UT-LVM FOCUS LED 12W 11305

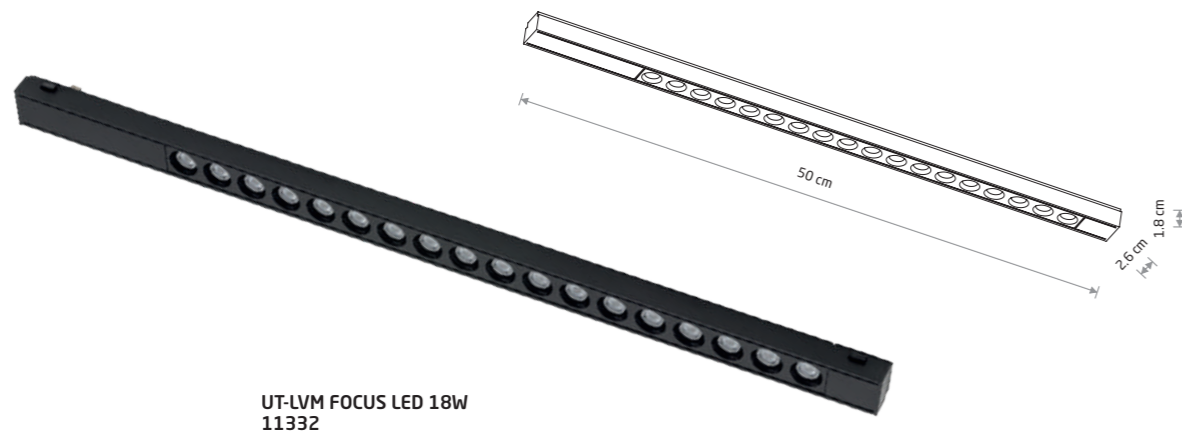

UT-LVM FOCUS LED 18W
11332

UT-LVM FOCUS LED 18W

aluminum

■ 11306 3000K ■ 11332 4000K



UT-LVM FOCUS LED 12W
11331

UT-LVM FOCUS LED 12W

aluminum

■ 11305 3000K ■ 11331 4000K



Item No.	Power	Colour temp.	Luminous flux	Beam angle	Colour Rendering Index (CRI)	Voltage DC	Safety type	Ingress protection	Lifetime
11306	18W LED	3000K	1500 lm	30°	≥90	48V	⚡	IP20	40000h
11332	18W LED	4000K	1500 lm	30°	≥90	48V	⚡	IP20	40000h

Item No.	Power	Colour temp.	Luminous flux	Beam angle	Colour Rendering Index (CRI)	Voltage DC	Safety type	Ingress protection	Lifetime
11305	12W LED	3000K	1000 lm	30°	≥90	48V	⚡	IP20	40000h
11331	12W LED	4000K	1000 lm	30°	≥90	48V	⚡	IP20	40000h



UT-LVM LINE LED 18W 11308



UT-LVM LINE LED 12W 11307

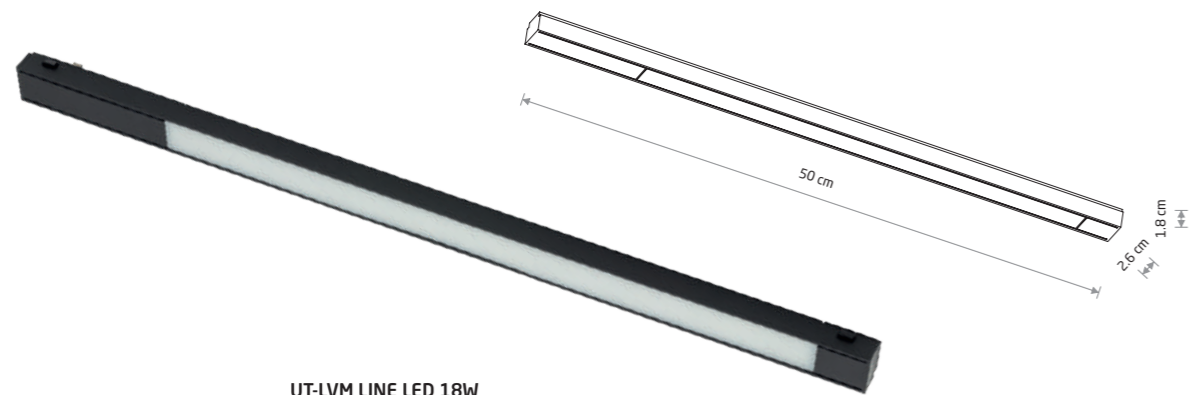

UT-LVM LINE LED 18W 11334

UT-LVM LINE LED 18W

aluminum

■ 11308 3000K ■ 11334 4000K

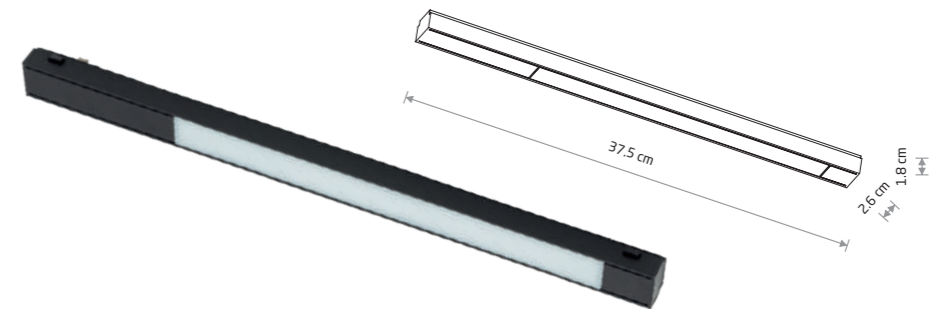

UT-LVM LINE LED 12W 11333

UT-LVM LINE LED 12W

aluminum

■ 11307 3000K ■ 11333 4000K



Item No.	Power	Colour temp.	Luminous flux	Beam angle	Colour Rendering Index (CRI)	Voltage DC	Safety type	Power factor	Lifetime
11308	18W LED	3000K	1500 lm	110°	≥90	48V	⚡	IP20	40000h
11334	18W LED	4000K	1500 lm	110°	≥90	48V	⚡	IP20	40000h

Item No.	Power	Colour temp.	Luminous flux	Beam angle	Colour Rendering Index (CRI)	Voltage DC	Safety type	Power factor	Lifetime
11307	12W LED	3000K	1000 lm	110°	≥90	48V	⚡	IP20	40000h
11333	12W LED	4000K	1000 lm	110°	≥90	48V	⚡	IP20	40000h



UT-LVM FOCUS OUT LED 12W 11313



UT-LVM FOCUS OUT LED 6W 11312



UT-LVM FOCUS OUT LED 12W 11338

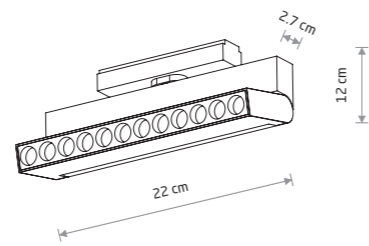

UT-LVM FOCUS OUT LED 12W

aluminum

■ 11313 3000K ■ 11338 4000K



UT-LVM FOCUS OUT LED 6W 11337

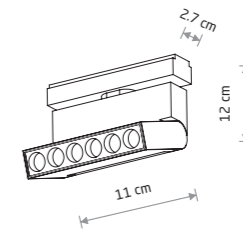

UT-LVM FOCUS OUT LED 6W

aluminum

■ 11312 3000K ■ 11337 4000K



Item No.	Power	Colour temp.	Luminous flux	Beam angle	Colour Rendering Index (CRI)	Voltage DC	Safety type	Ingress protection	Lifetime
11313	12W LED	3000K	1000 lm	30°	≥90	48V	⚡	IP20	40000h
11338	12W LED	4000K	1000 lm	30°	≥90	48V	⚡	IP20	40000h

Item No.	Power	Colour temp.	Luminous flux	Beam angle	Colour Rendering Index (CRI)	Voltage DC	Safety type	Ingress protection	Lifetime
11312	6W LED	3000K	500 lm	30°	≥90	48V	⚡	IP20	40000h
11337	6W LED	4000K	500 lm	30°	≥90	48V	⚡	IP20	40000h



UT-LVM FOCUS SWING LED 12W 11311



UT-LVM FOCUS SWING LED 6W 11310



UT-LVM FOCUS SWING LED 12W 11336

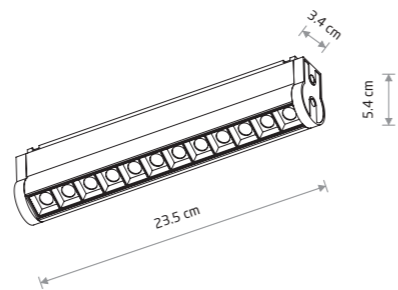

UT-LVM FOCUS SWING LED 12W

aluminum

■ 11311 3000K ■ 11336 4000K



UT-LVM FOCUS SWING LED 6W 11335

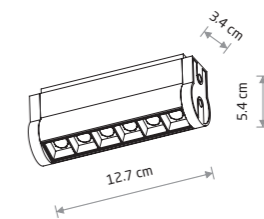

UT-LVM FOCUS SWING LED 6W

aluminum

■ 11310 3000K ■ 11335 4000K



Item No.	Power	Colour temp.	Luminous flux	Beam angle	Colour Rendering Index (CRI)	Voltage DC	Safety type	Ingress protection	Lifetime
11311	12W LED	3000K	1000 lm	30°	≥90	48V	⚡	IP20	40000h
11336	12W LED	4000K	1000 lm	30°	≥90	48V	⚡	IP20	40000h

Item No.	Power	Colour temp.	Luminous flux	Beam angle	Colour Rendering Index (CRI)	Voltage DC	Safety type	Ingress protection	Lifetime
11310	6W LED	3000K	500 lm	30°	≥90	48V	⚡	IP20	40000h
11335	6W LED	4000K	500 lm	30°	≥90	48V	⚡	IP20	40000h



UT-LVM SPOT LED 5W 11314



UT-LVM SPOT LED 9W 11315



UT-LVM SPOT LED 5W
11340

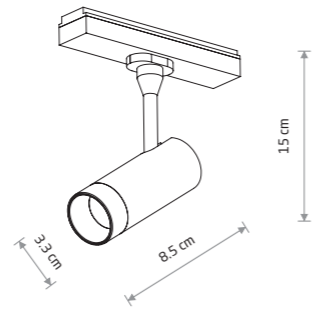

UT-LVM SPOT LED 5W

aluminum

■ 11314 3000K ■ 11340 4000K



UT-LVM SPOT LED 9W
11341

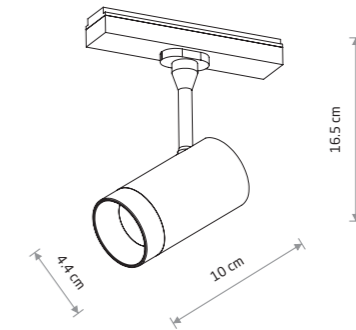

UT-LVM SPOT LED 9W

aluminum

■ 11315 3000K ■ 11341 4000K



Item No.	Power	Colour temp.	Luminous flux	Beam angle	Colour Rendering Index (CRI)	Voltage DC	Safety type	Ingress protection	Lifetime
11314	5W LED	3000K	450 lm	36°	≥90	48V	⚡	IP20	40000h
11340	5W LED	4000K	450 lm	36°	≥90	48V	⚡	IP20	40000h

Item No.	Power	Colour temp.	Luminous flux	Beam angle	Colour Rendering Index (CRI)	Voltage DC	Safety type	Ingress protection	Lifetime
11315	9W LED	3000K	850 lm	36°	≥90	48V	⚡	IP20	40000h
11341	9W LED	4000K	850 lm	36°	≥90	48V	⚡	IP20	40000h



UT-LVM SPOT LED 12W 11316



UT-LVM SPOT LED 12W 11342

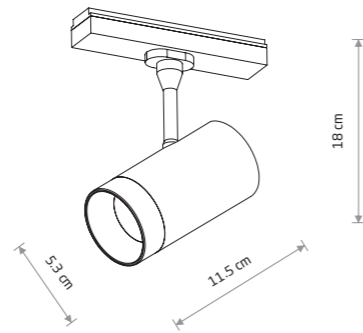

UT-LVM SPOT LED 12W

aluminum

■ 11316 3000K ■ 11342 4000K

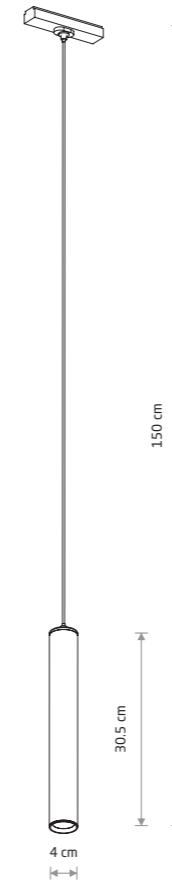

UT-LVM ROLLER LED 10W

aluminum

■ 11317 3000K ■ 11343 4000K



UT-LVM ROLLER LED 10W 11317

Item No.	Power	Colour temp.	Luminous flux	Beam angle	Colour Rendering Index (CRI)	Voltage DC	Safety type	Ingress protection	Lifetime
11316	12W LED	3000K	1200 lm	36°	≥90	48V	⚡	IP20	40000h
11342	12W LED	4000K	1200 lm	36°	≥90	48V	⚡	IP20	40000h

Item No.	Power	Colour temp.	Luminous flux	Beam angle	Colour Rendering Index (CRI)	Voltage DC	Safety type	Ingress protection	Lifetime
11317	10W LED	3000K	1000 lm	36°	≥90	48V	⚡	IP20	40000h
11343	10W LED	4000K	1000 lm	36°	≥90	48V	⚡	IP20	40000h

SPOSOBY MONTAŻU / INSTALLATION METHODS

1



SURFACE CONNECTION

2



SURFACE CONNECTION

3



SURFACE CONNECTION

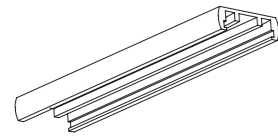

UT-LVM TRACK

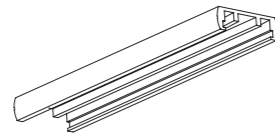

UT-LVM TRACK

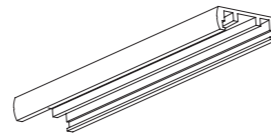

UT-LVM TRACK

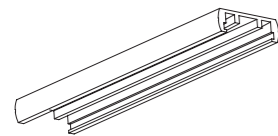

UT-LVM TRACK

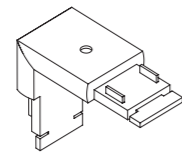

UT-LVM VERTICAL CONNECTOR

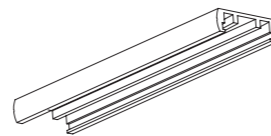

UT-LVM TRACK

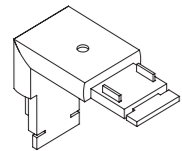

UT-LVM VERTICAL CONNECTOR

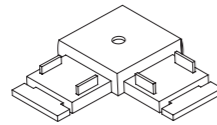

UT-LVM L CONNECTOR

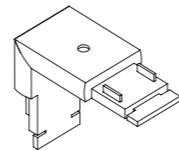

UT-LVM VERTICAL CONNECTOR

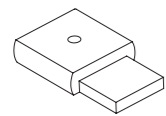

UT-LVM END CAP

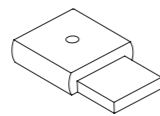

UT-LVM END CAP

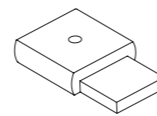

UT-LVM END CAP

UT-LVM TRACK LIGHT SYSTEM 48V

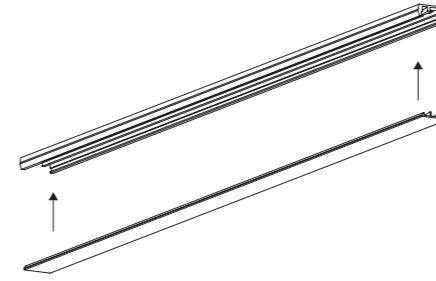

Zestaw zawiera listwę maskującą
Set includes a masking strip

1

UT-LVM TRACK 1M

aluminum

11320

2

UT-LVM TRACK 2M

aluminum

11318

Schemat zasilania / Power supply circuit diagram

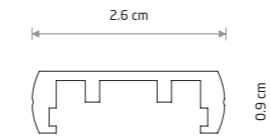
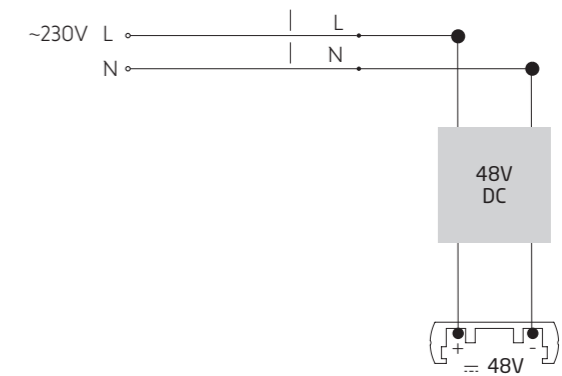

System szynoprzewodowy (UT-LVM) należy równomiernie obciążyć elektrycznie oraz równomiernie rozmieścić oprawy na jego długości.
Zalecany dystans pomiędzy mocowaniami max. 1000 mm.
Maksymalna długość systemu szynoprzewodowego z jednego źródła zasilania - 20 m.

The track light system (UT-LVM) should be evenly electrically loaded and the fittings should be evenly placed along its length.
The recommended fastening distance is max. 1000 mm.
Maximum length of track light system with a single power source is 20 m.

SPOSOBY MONTAŻU / INSTALLATION METHODS

1. Montaż bezpośredni
1. Surface mounting

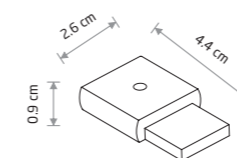
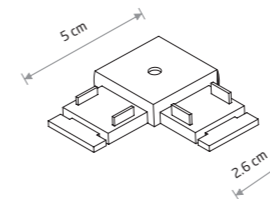
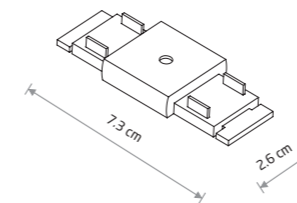
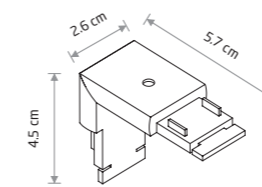
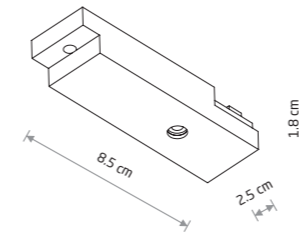
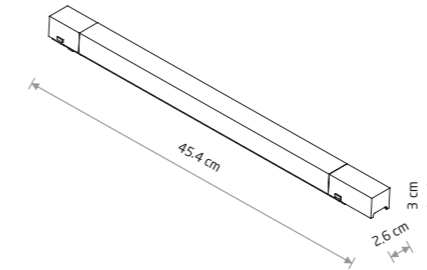
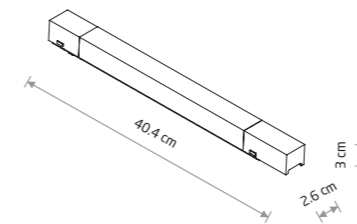

- 3** UT-LVM 48V, 100W
INSIDE POWER SUPPLY
aluminum
■ 11328
- 4** UT-LVM 48V, 200W
INSIDE POWER SUPPLY
aluminum
■ 11330
- 5** UT-LVM OUTSIDE
POWER SUPPLY
CONDUCTIVE MODULE
plastic, copper
■ 11321
- 6** UT-LVM VERTICAL
CONNECTOR
plastic, copper
■ 11326
- 7** UT-LVM STRAIGHT
CONNECTOR
plastic, copper
■ 11322
- 8** UT-LVM L CONNECTOR
plastic, copper
■ 11325
- 9** UT-LVM END CAP
plastic
■ 11327



LVM Track Light System 48V



LVM FOCUS LED 15W 10150



LVM FOCUS LED 9W 10144

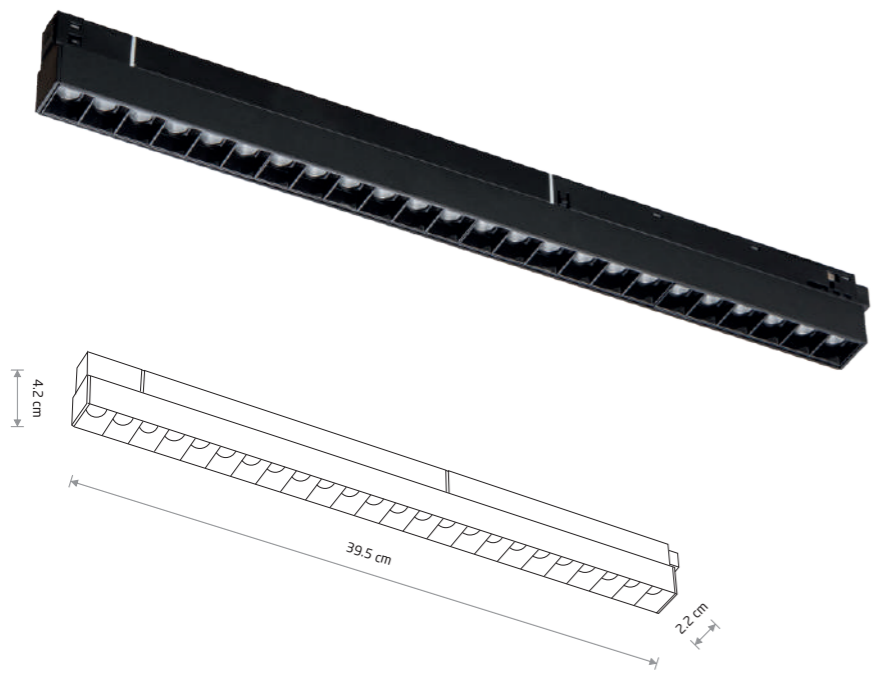

LVM FOCUS LED 15W
10643

LVM FOCUS LED 15W
painted aluminum, plastic

- 10150 3000K ■ 10643 4000K
- 11630 3000K □ 11631 4000K

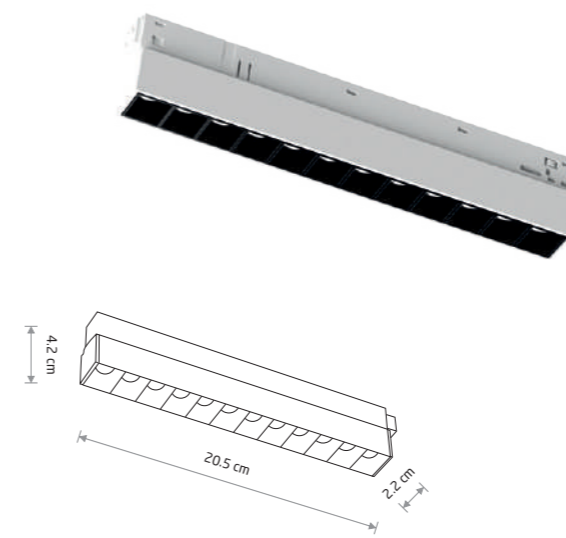

LVM FOCUS LED 9W
11632

LVM FOCUS LED 9W
painted aluminum, plastic

- 10144 3000K ■ 10644 4000K
- 11632 3000K □ 11633 4000K

Item No.	Power	Colour temp.	Luminous flux	Beam angle	Colour Rendering Index (CRI)	Voltage DC	Safety type	Ingress protection	Lifetime
10150	15W LED	3000K	1300 lm	30°	>90	48V	⚡	IP20	30000h
10643	15W LED	4000K	1400 lm	30°	>90	48V	⚡	IP20	30000h
11630	15W LED	3000K	1300 lm	30°	>90	48V	⚡	IP20	30000h
11631	15W LED	4000K	1400 lm	30°	>90	48V	⚡	IP20	30000h

Item No.	Power	Colour temp.	Luminous flux	Beam angle	Colour Rendering Index (CRI)	Voltage DC	Safety type	Ingress protection	Lifetime
10144	9W LED	3000K	800 lm	30°	>90	48V	⚡	IP20	30000h
10644	9W LED	4000K	880 lm	30°	>90	48V	⚡	IP20	30000h
11632	9W LED	3000K	800 lm	30°	>90	48V	⚡	IP20	30000h
11633	9W LED	4000K	880 lm	30°	>90	48V	⚡	IP20	30000h

■ BLACK □ WHITE

□ WHITE ■ BLACK



LVM FOCUS OUT LED 15W 10151



LVM FOCUS OUT LED 9W 10145



LVM FOCUS OUT LED 15W
10645

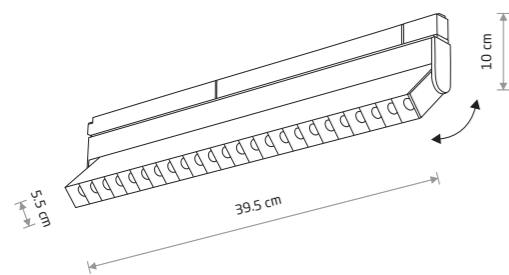

LVM FOCUS OUT LED 15W

■ painted aluminum, plastic

■ 10151 3000K ■ 10645 4000K



LVM FOCUS OUT LED 9W
11634

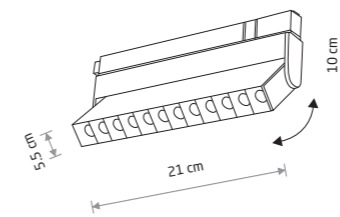

LVM FOCUS OUT LED 9W

■ painted aluminum, plastic

■ 10145 3000K ■ 10646 4000K

■ 11634 3000K ■ 11635 4000K



Item No.	Power	Colour temp.	Luminous flux	Beam angle	Colour Rendering Index (CRI)	Voltage DC	Safety type	Ingress protection	Lifetime
10151	15W LED	3000K	1300 lm	30°	>90	48V	⚡	IP20	30000h
10645	15W LED	4000K	1400 lm	30°	>90	48V	⚡	IP20	30000h

Item No.	Power	Colour temp.	Luminous flux	Beam angle	Colour Rendering Index (CRI)	Voltage DC	Safety type	Ingress protection	Lifetime
10145	9W LED	3000K	800 lm	30°	>90	48V	⚡	IP20	30000h
10646	9W LED	4000K	880 lm	30°	>90	48V	⚡	IP20	30000h
11634	9W LED	3000K	800 lm	30°	>90	48V	⚡	IP20	30000h
11635	9W LED	4000K	880 lm	30°	>90	48V	⚡	IP20	30000h

■ BLACK ■ WHITE

■ WHITE ■ BLACK



LVM LINE LED 15W 10148



LVM LINE LED 9W 10143

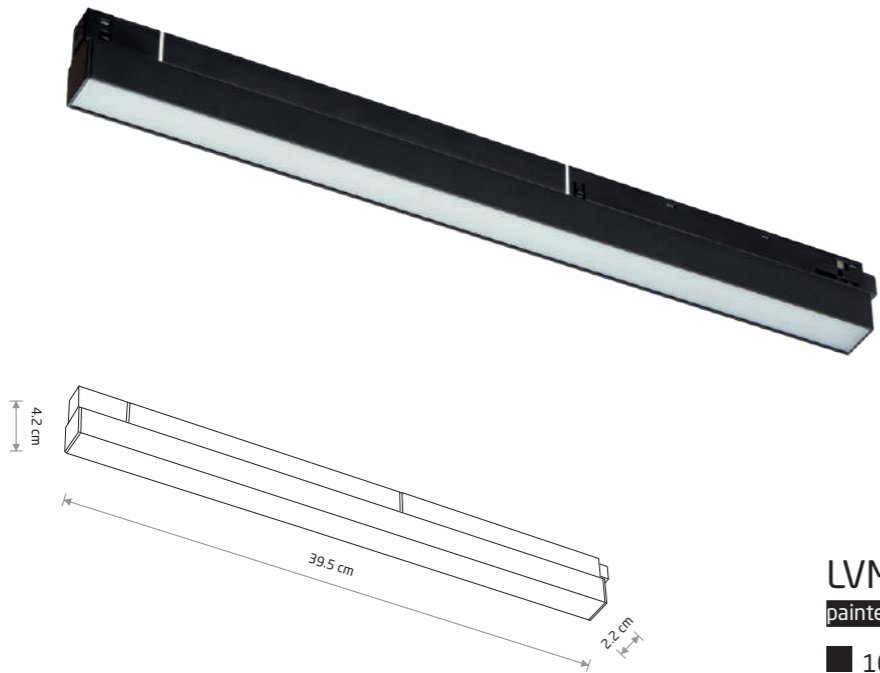

LVM LINE LED 15W
10650

LVM LINE LED 15W

Painted aluminum, plastic

- 10148 3000K ■ 10650 4000K
- 11636 3000K □ 11637 4000K



LVM LINE LED 9W
10651

LVM LINE LED 9W

Painted aluminum, plastic

- 10143 3000K ■ 10651 4000K
- 11638 3000K □ 11639 4000K

Item No.	Power	Colour temp.	Luminous flux	Beam angle	Colour Rendering Index (CRI)	Voltage DC	Safety type	Ingress protection	Lifetime
10148	15W LED	3000K	700 lm	110°	>90	48V	III	IP20	30000h
10650	15W LED	4000K	770 lm	110°	>90	48V	III	IP20	30000h
11636	15W LED	3000K	700 lm	110°	>90	48V	III	IP20	30000h
11637	15W LED	4000K	770 lm	110°	>90	48V	III	IP20	30000h

Item No.	Power	Colour temp.	Luminous flux	Beam angle	Colour Rendering Index (CRI)	Voltage DC	Safety type	Ingress protection	Lifetime
10143	9W LED	3000K	400 lm	110°	>90	48V	III	IP20	30000h
10651	9W LED	4000K	440 lm	110°	>90	48V	III	IP20	30000h
11638	9W LED	3000K	400 lm	110°	>90	48V	III	IP20	30000h
11639	9W LED	4000K	440 lm	110°	>90	48V	III	IP20	30000h

■ BLACK □ WHITE

□ WHITE ■ BLACK



LVM SPOT LED 15W 10147



LVM SPOT LED 9W 10142



LVM SPOT LED 15W 10655



LVM SPOT LED 9W 10656

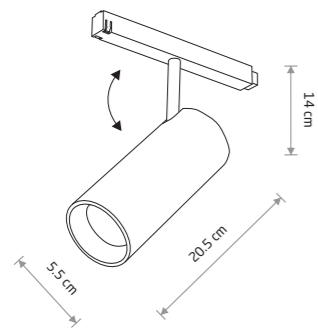

LVM SPOT LED 15W

painting aluminum, plastic

- 10147 3000K ■ 10655 4000K
- 11642 3000K □ 11643 4000K

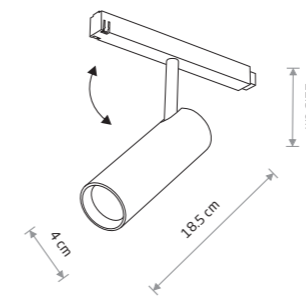

LVM SPOT LED 9W

painting aluminum, plastic

- 10142 3000K ■ 10656 4000K
- 11644 3000K □ 11645 4000K



Item No.	Power	Colour temp.	Luminous flux	Beam angle	Colour Rendering Index (CRI)	Voltage DC	Safety type	Ingress protection	Lifetime
10147	15W LED	3000K	1020 lm	30°	>90	48V	⚡	IP20	30000h
10655	15W LED	4000K	1100 lm	30°	>90	48V	⚡	IP20	30000h
11642	15W LED	3000K	1020 lm	30°	>90	48V	⚡	IP20	30000h
11643	15W LED	4000K	1100 lm	30°	>90	48V	⚡	IP20	30000h

Item No.	Power	Colour temp.	Luminous flux	Beam angle	Colour Rendering Index (CRI)	Voltage DC	Safety type	Ingress protection	Lifetime
10142	9W LED	3000K	780 lm	30°	>90	48V	⚡	IP20	30000h
10656	9W LED	4000K	850 lm	30°	>90	48V	⚡	IP20	30000h
11644	9W LED	3000K	780 lm	30°	>90	48V	⚡	IP20	30000h
11645	9W LED	4000K	850 lm	30°	>90	48V	⚡	IP20	30000h

■ BLACK □ WHITE

□ WHITE ■ BLACK



LVM ROLLER LED 9W
10652

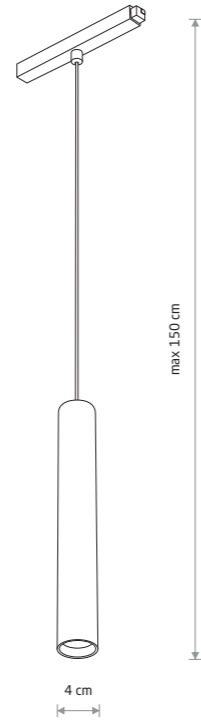

LVM ROLLER LED 9W

painted aluminum, plastic

- 10146 3000K ■ 10652 4000K
- 11640 3000K □ 11641 4000K



Item No.	Power	Colour temp.	Luminous flux	Beam angle	Colour Rendering Index (CRI)	Voltage DC	Safety type	Ingress protection	Lifetime
10146	9W LED	3000K	620 lm	36°	>90	48V	⚡	IP20	30000h
10652	9W LED	4000K	680 lm	36°	>90	48V	⚡	IP20	30000h
11640	9W LED	3000K	620 lm	36°	>90	48V	⚡	IP20	30000h
11641	9W LED	4000K	680 lm	36°	>90	48V	⚡	IP20	30000h

■ BLACK □ WHITE



Visualisation by Iwona Ligęza



LVM LID LED 8W
10647

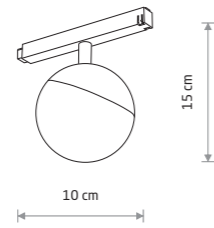

LVM LID LED 8W

■ painted aluminum, plastic PMMA

■ 10152 3000K ■ 10647 4000K



LVM LID LED 8W
10648

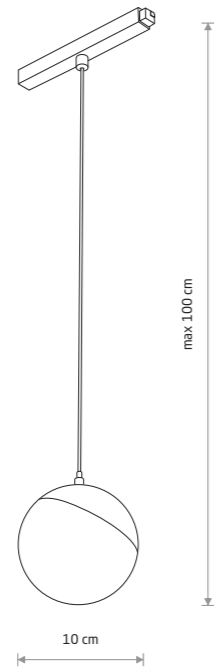

LVM LID LED 8W

■ painted aluminum, plastic PMMA

■ 10153 3000K ■ 10648 4000K



LVM SLOT LED 5W
10653

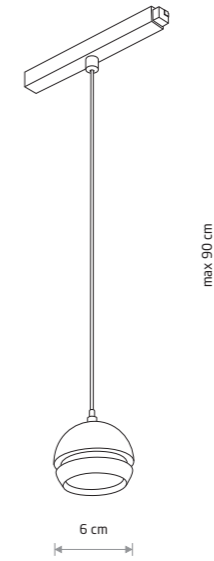

LVM SLOT LED 5W

■ painted aluminum, plastic PMMA

■ 10154 3000K ■ 10653 4000K



LVM SLOT LED 8W
10654

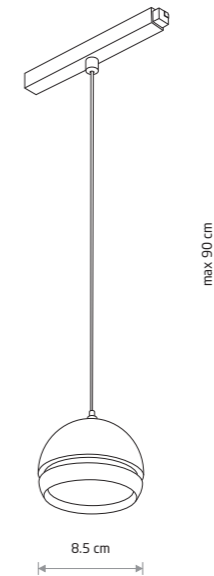

LVM SLOT LED 8W

■ painted aluminum, plastic PMMA

■ 10155 3000K ■ 10654 4000K



Item No.	Power	Colour temp.	Luminous flux	Beam angle	Colour Rendering Index (CRI)	Voltage DC	Safety type	Ingress protection	Lifetime
10152	8W LED	3000K	650 lm	160°	>90	48v	III	IP20	30000h
10647	8W LED	4000K	650 lm	160°	>90	48v	III	IP20	30000h
10153	8W LED	3000K	650 lm	160°	>90	48v	III	IP20	30000h
10648	8W LED	4000K	650 lm	160°	>90	48v	III	IP20	30000h

Item No.	Power	Colour temp.	Luminous flux	Beam angle	Colour Rendering Index (CRI)	Voltage DC	Safety type	Ingress protection	Lifetime
10154	5W LED	3000K	210 lm	100°	>90	48v	III	IP20	30000h
10653	5W LED	4000K	250 lm	100°	>90	48v	III	IP20	30000h
10155	8W LED	3000K	370 lm	100°	>90	48v	III	IP20	30000h
10654	8W LED	4000K	400 lm	100°	>90	48v	III	IP20	30000h

SPOSOBY MONTAŻU / INSTALLATION METHODS

1



SURFACE CONNECTION

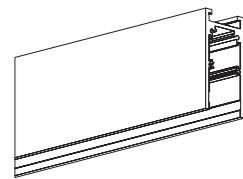

LVM TRACK

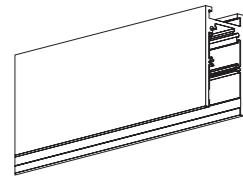

LVM TRACK

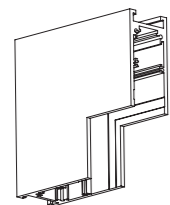

LVM INSIDE CORNER

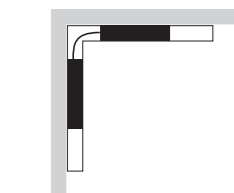

ELECTRICAL CONNECTION
LVM CORNER CONDUCTIVE
MODULE

2



RECESSED - SURFACE
CONNECTION

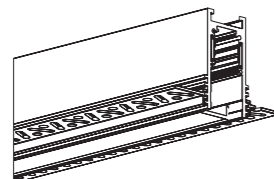

LVM RECESSED TRACK

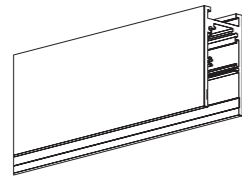

LVM TRACK

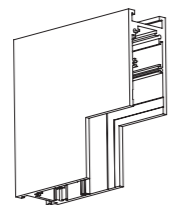

LVM INSIDE CORNER

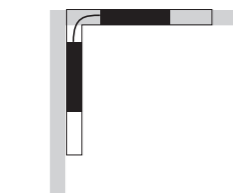

ELECTRICAL CONNECTION
LVM CORNER CONDUCTIVE
MODULE

3



SURFACE - RECESSED
CONNECTION

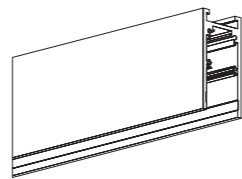

LVM TRACK

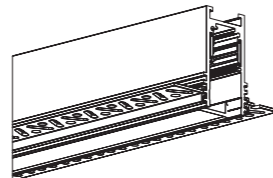

LVM RECESSED TRACK

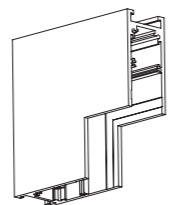

LVM INSIDE CORNER

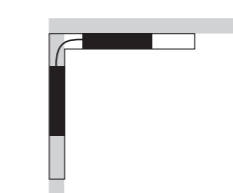

ELECTRICAL CONNECTION
LVM CORNER CONDUCTIVE
MODULE

4



RECESSED CONNECTION

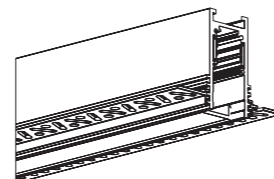

LVM RECESSED TRACK

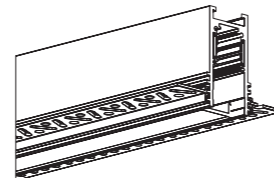

LVM RECESSED TRACK

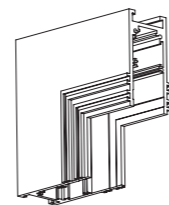

LVM RECESSED
INSIDE CORNER

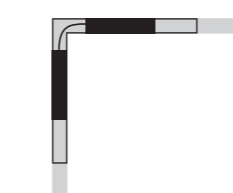

ELECTRICAL CONNECTION
LVM CORNER CONDUCTIVE
MODULE

5



SURFACE CONNECTION

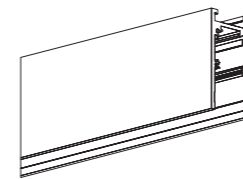

LVM TRACK

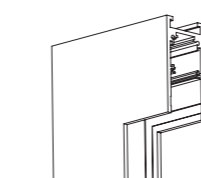

LVM INSIDE CORNER

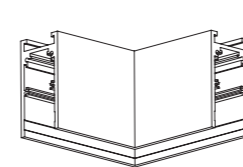

LVM HORIZONTAL
CORNER

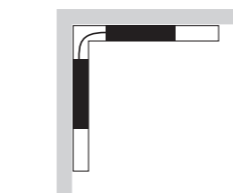

ELECTRICAL CONNECTION
LVM CORNER CONDUCTIVE
MODULE

6



RECESSED CONNECTION

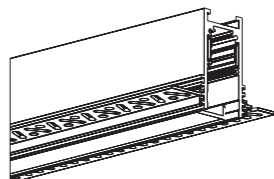

LVM RECESSED TRACK

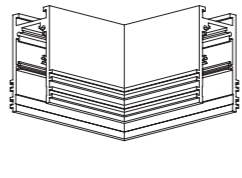

LVM RECESSED
HORIZONTAL CORNER

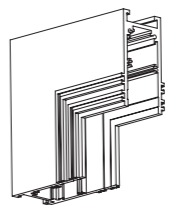

LVM RECESSED
INSIDE CORNER

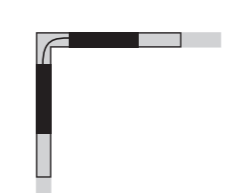

ELECTRICAL CONNECTION
LVM CORNER CONDUCTIVE
MODULE

7



SUSPENDED CONNECTION

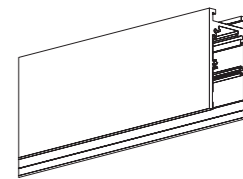

LVM TRACK

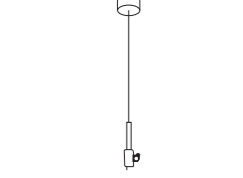

LVM POWER SUPPLY KIT

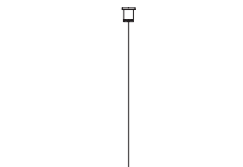

LVM SUSPENSION
KIT

SPOSOBY MONTAŻU / INSTALLATION METHODS

8



SURFACE CONNECTION

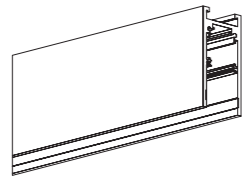

LVM TRACK

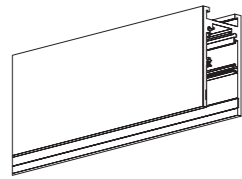

LVM TRACK

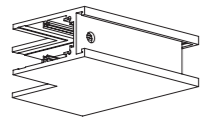

LVM INSIDE CORNER

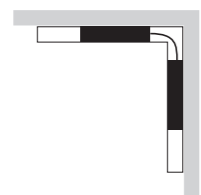

ELECTRICAL CONNECTION
LVM CORNER CONDUCTIVE
MODULE

9

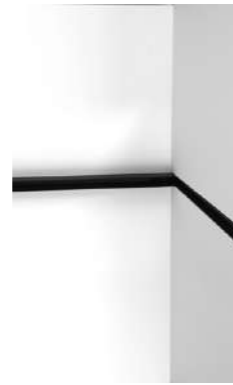

RECESSED - SURFACE
CONNECTION

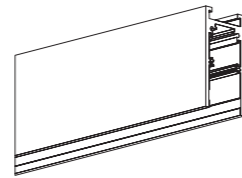

LVM TRACK

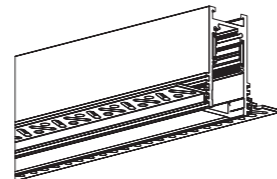

LVM RECESSED TRACK

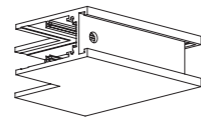

LVM INSIDE CORNER

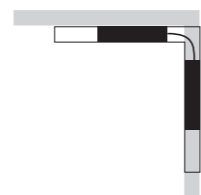

ELECTRICAL CONNECTION
LVM CORNER CONDUCTIVE
MODULE

10



SURFACE - RECESSED
CONNECTION

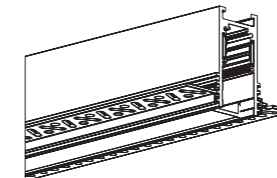

LVM RECESSED TRACK

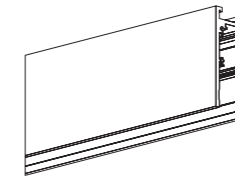

LVM TRACK

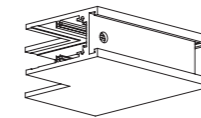

LVM INSIDE CORNER

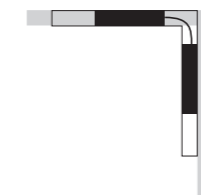

ELECTRICAL CONNECTION
LVM CORNER CONDUCTIVE
MODULE

11

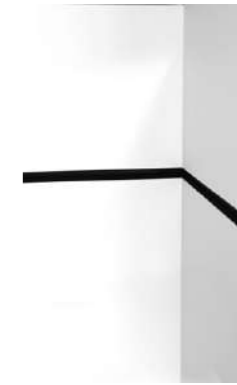

RECESSED CONNECTION

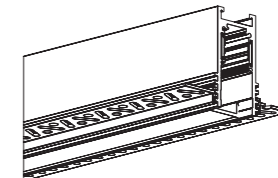

LVM RECESSED TRACK

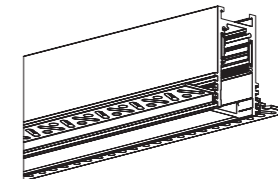

LVM RECESSED TRACK

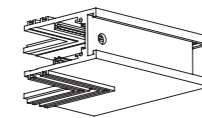

LVM RECESSED
INSIDE CORNER

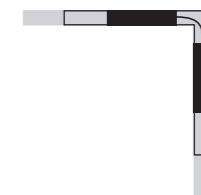

ELECTRICAL CONNECTION
LVM CORNER CONDUCTIVE
MODULE

LVM - LOW VOLTAGE MAGNETIC TRACK LIGHT SYSTEM

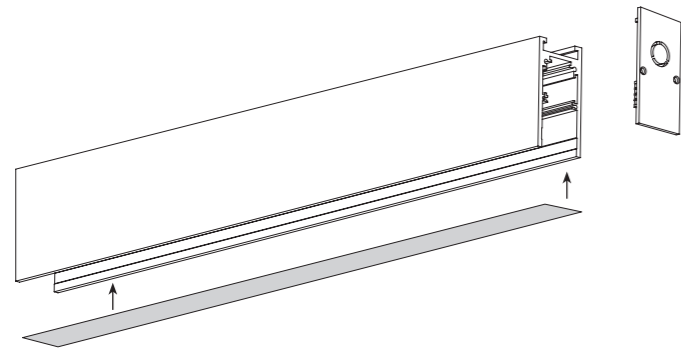

Zestaw zawiera listwę maskującą i 2 zatyczki
Set includes a masking strip and 2 plugs

1 LVM TRACK 1M

aluminum

10162 11626

2 LVM TRACK 2M

aluminum

10163 11627

Schemat zasilania / Power supply circuit diagram

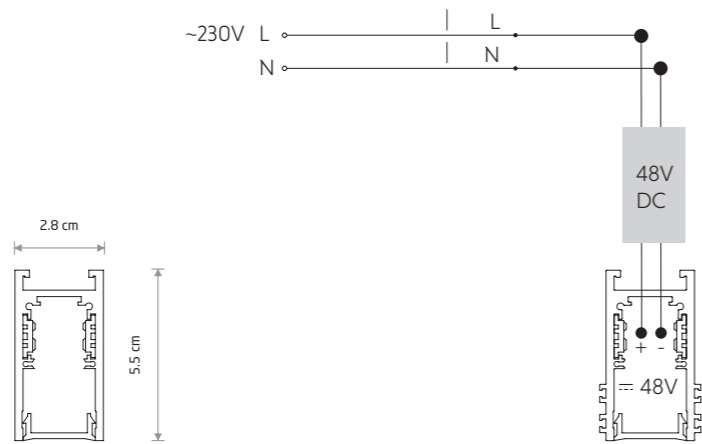

System szynoprzewodowy (LVM) należy równomiernie obciążyć elektrycznie oraz równomiernie rozmieścić oprawy na jego długości.
Zalecany dystans pomiędzy mocowaniami max. 1000 mm.
Maksymalna długość systemu szynoprzewodowego z jednego źródła zasilania - 20 m.

The track light system (LVM) should be evenly electrically loaded and the fittings should be evenly placed along its length.
The recommended fastening distance is max. 1000 mm.
Maximum length of track light system with a single power source is 20 m.

BLACK WHITE

Sposób montażu / Installation method

- Zwieszenie na linkach
- Suspended on steel wires

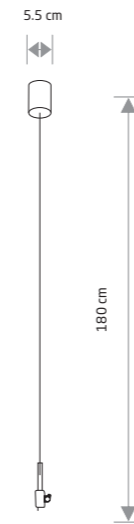

3 LVM POWER SUPPLY KIT

plastic, painted steel

10597 11803



4 LVM SUSPENSION KIT

steel

10170



WHITE SILVER BLACK

Sposób montażu / Installation method

2. Montaż bezpośredni
2. Surface mounting

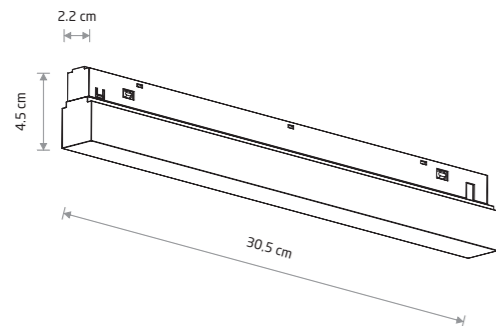
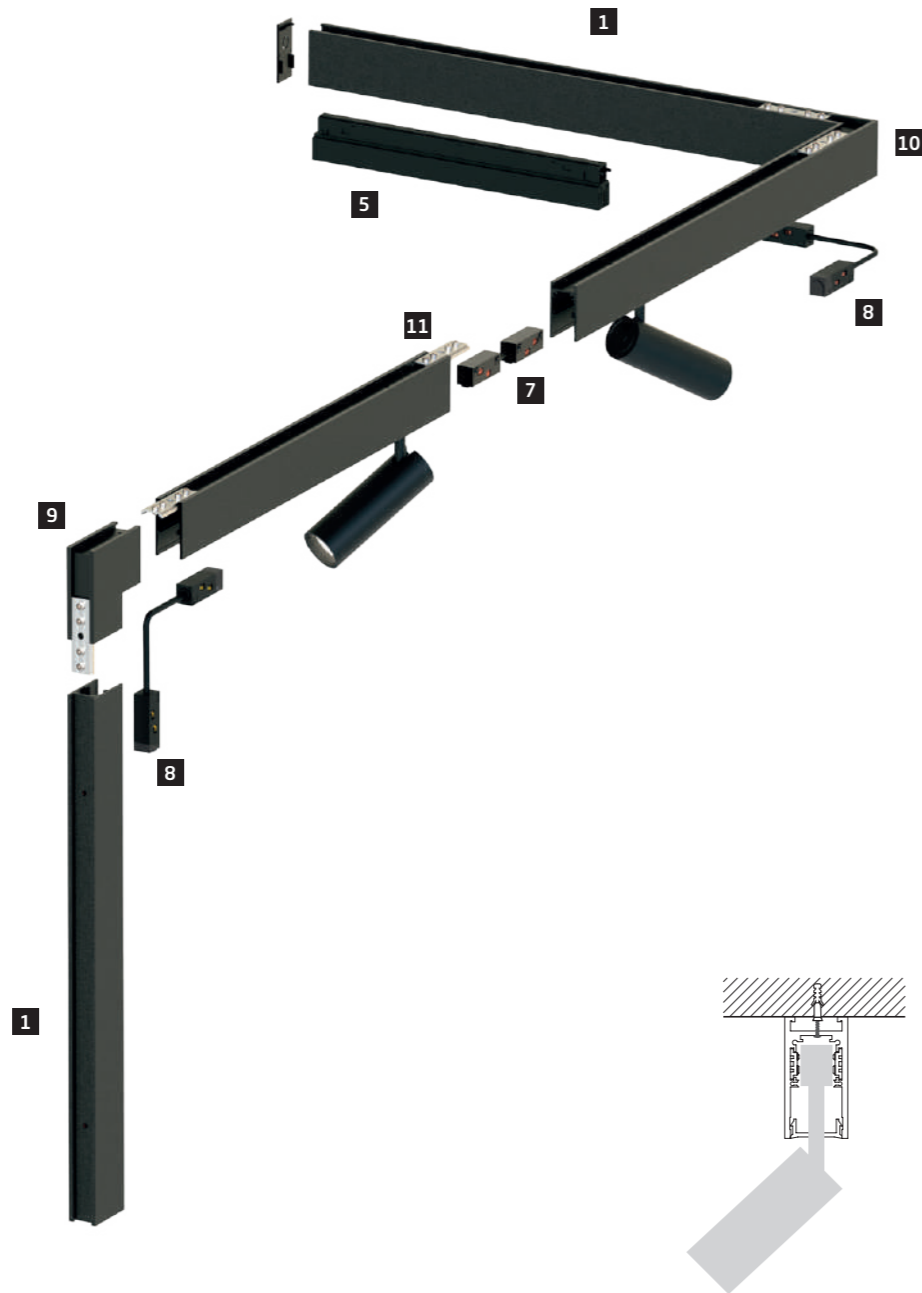

5 LVM 48V, 150W,
INSIDE POWER SUPPLY
aluminum
■ 10161 □ 11616

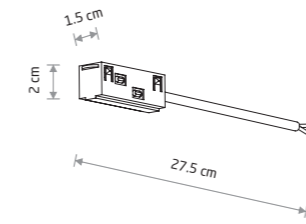

6 LVM OUTSIDE POWER SUPPLY
CONDUCTIVE MODULE
plastic
■ 10168 □ 11621

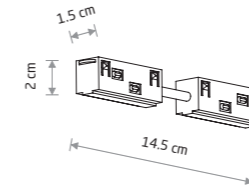

7 LVM STRAIGHT
CONDUCTIVE MODULE
plastic
■ 10167 □ 11628

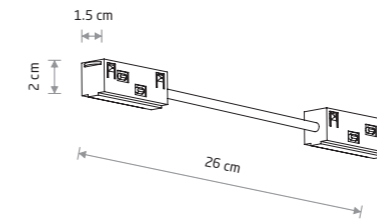

8 LVM CORNER
CONDUCTIVE MODULE
plastic
■ 10166 □ 11617

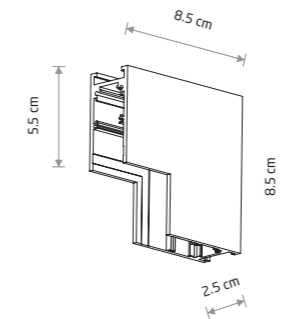

9 LVM INSIDE CORNER
aluminum
■ 10165 □ 11620
includes 2xLVM TRACK BUCKLE CONNECTOR

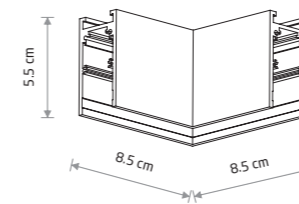

10 LVM HORIZONTAL
CORNER
aluminum
■ 10164 □ 11618
includes 2xLVM TRACK BUCKLE CONNECTOR

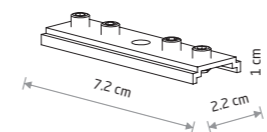

11 LVM TRACK BUCKLE
CONNECTOR
steel
■ 10171

LVM - RECESSED LOW VOLTAGE MAGNETIC TRACK LIGHT SYSTEM

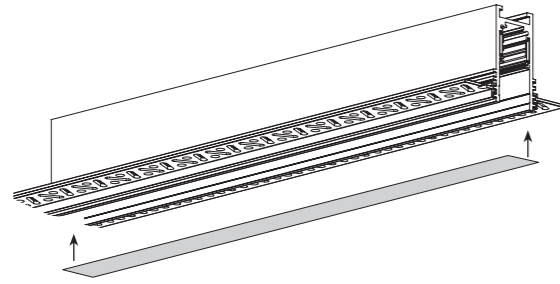

Zestaw zawiera listwę maskującą i 2 zatyczki
Set includes a masking strip and 2 plugs

1 LVM RECESSED TRACK 1M

aluminum

■ 10156 □ 11624

2 LVM RECESSED TRACK 2M

aluminum

■ 10157 □ 11625

Schemat zasilania / Power supply circuit diagram

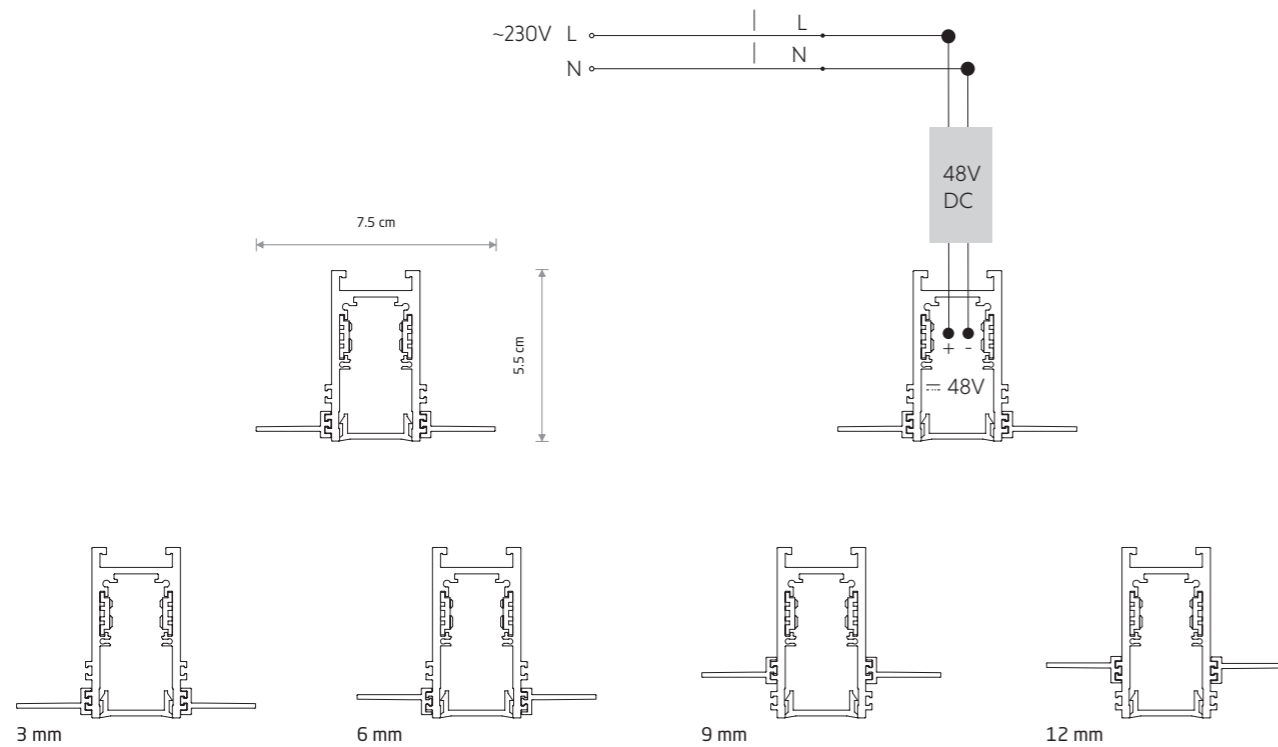

Konstrukcja szynoprzewodów umożliwia dostosowanie wysokości skrzydełek do różnych grubości płyt gipsowo-kartonowych.
Możliwa regulacja to: 3, 6, 9 i 12 mm.
System szynoprzewodowy (LVM) należy równomiernie obciążyć elektrycznie oraz równomiernie rozmieścić oprawy na jego długości.
Zalecany dystans pomiędzy mocowaniami max. 1000 mm.
Maksymalna długość systemu szynoprzewodowego z jednego źródła zasilania - 20 m.

The design of the track light system makes it possible to adjust the height of the wings for different thicknesses of drywall.
Possible adjustments are: 3, 6, 9 and 12 mm.
The track light system (LVM) should be evenly electrically loaded and the fittings should be evenly placed along its length.
The recommended fastening distance is max. 1000 mm.
Maximum length of track light system with a single power source is 20 m.

Sposób montażu / Installation method

1. Montaż podtynkowy
1. Recessed mounting

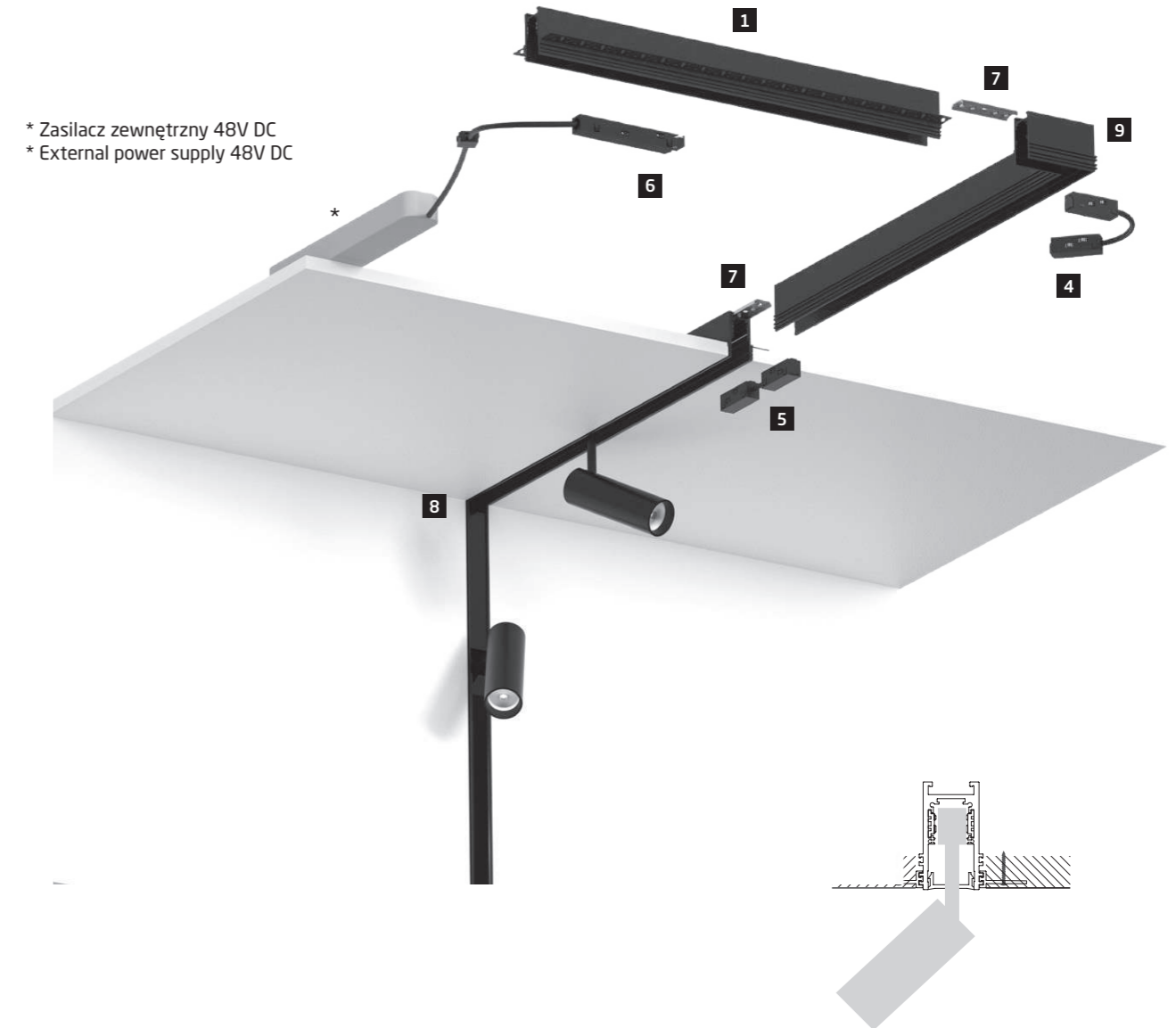

* Zasilacz zewnętrzny 48V DC
* External power supply 48V DC

* Możliwość zastosowania zasilacza zewnętrznego 48V DC.
Zaleca się aby suma watażu użytych opraw nie przekraczała 90% mocy znamionowej zasilacza.
* Possibility of using an external 48V DC power supply.
It is recommended that the total wattage of the luminaires used does not exceed 90% of the power supply's rated power.

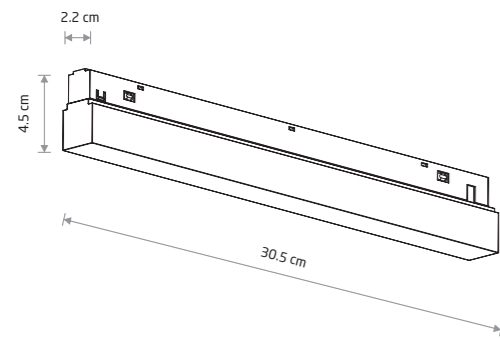

3 LVM 48V, 150W, INSIDE POWER SUPPLY

aluminium

■ 10161 □ 11616

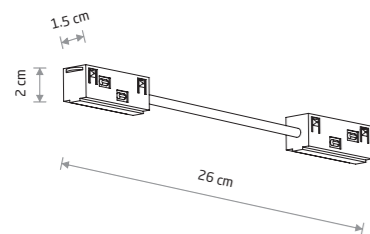

4 LVM CORNER CONDUCTIVE MODULE

plastic

■ 10166 □ 11617

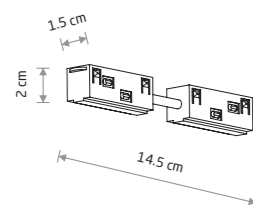

5 LVM STRAIGHT CONDUCTIVE MODULE

plastic

■ 10167 □ 11628

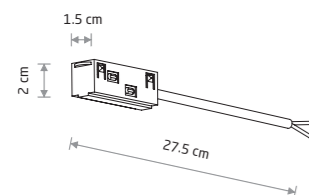

6 LVM OUTSIDE POWER SUPPLY CONDUCTIVE MODULE

plastic

■ 10168 □ 11621

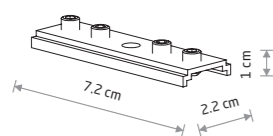

7 LVM TRACK BUCKLE CONNECTOR

steel

■ 10171

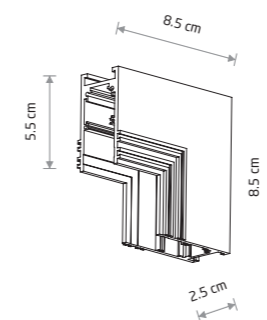

8 LVM RECESSED INSIDE CORNER

aluminium

■ 10160 □ 11623

includes 2xLVM TRACK BUCKLE CONNECTOR

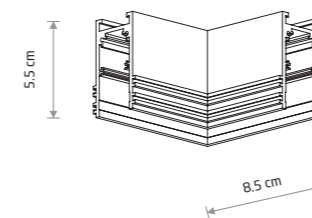

9 LVM RECESSED HORIZONTAL CORNER

aluminium

■ 10158 □ 11622

includes 2xLVM TRACK BUCKLE CONNECTOR

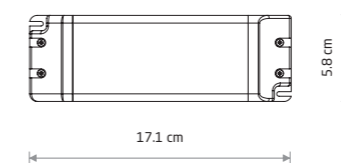

10 48V DC, 80W, POWER SUPPLY

plastic

11301



11 48V DC, 200W, POWER SUPPLY

plastic

11287

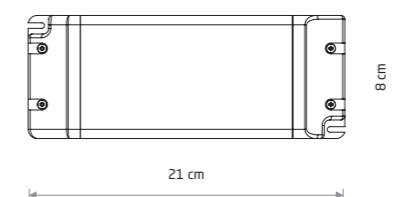

12 48V DC, 320W, POWER SUPPLY

plastic

11278



Visualisation by Iwona Ligeza

CTLS - Commercial Track Light System

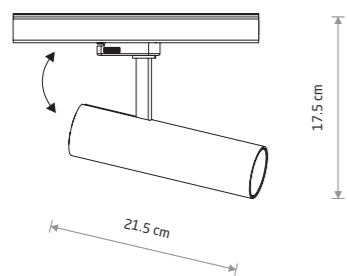
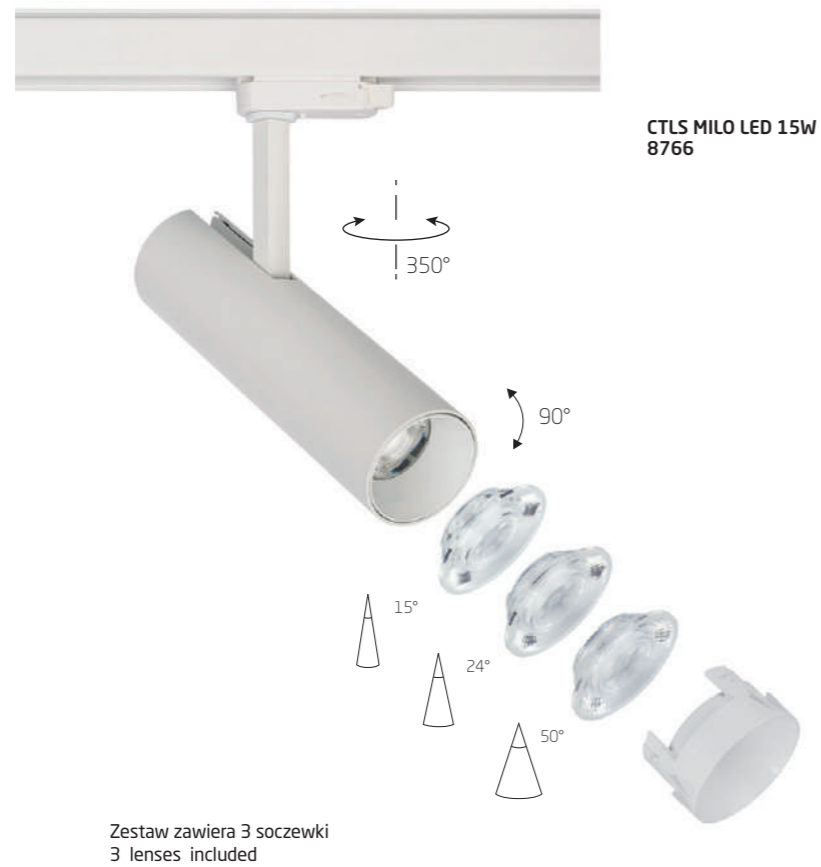

CTLS MILO LED 15W

zinc aluminum alloy

8766 3000K 8765 4000K

8764 3000K 8763 4000K

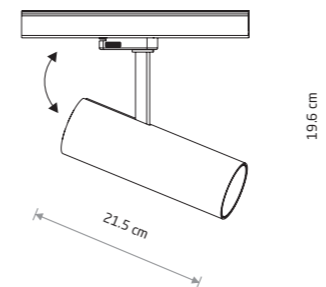

CTLS MILO LED 25W

zinc aluminum alloy

8762 3000K



Item No.	Power	Colour temp.	Luminous flux	Beam angle	Colour Rendering Index (CRI)	Ingress protection	LED brand	Driver brand	Lifetime	Warranty
8766	15W LED	3000K	1300 lm	15/24/50°	≥ 90	IP20	Samsung	Ostram	50000h	5 years
8765	15W LED	4000K	1300 lm	15/24/50°	≥ 90	IP20	Samsung	Ostram	50000h	5 years
8764	15W LED	3000K	1300 lm	15/24/50°	≥ 90	IP20	Samsung	Ostram	50000h	5 years
8763	15W LED	4000K	1300 lm	15/24/50°	≥ 90	IP20	Samsung	Ostram	50000h	5 years

Item No.	Power	Colour temp.	Luminous flux	Beam angle	Colour Rendering Index (CRI)	Ingress protection	LED brand	Driver brand	Lifetime	Warranty
8762	25W LED	3000K	1900 lm	15/24/40°	≥ 90	IP20	Samsung	Ostram	50000h	5 years



CTLS NEA LED 20W
8757

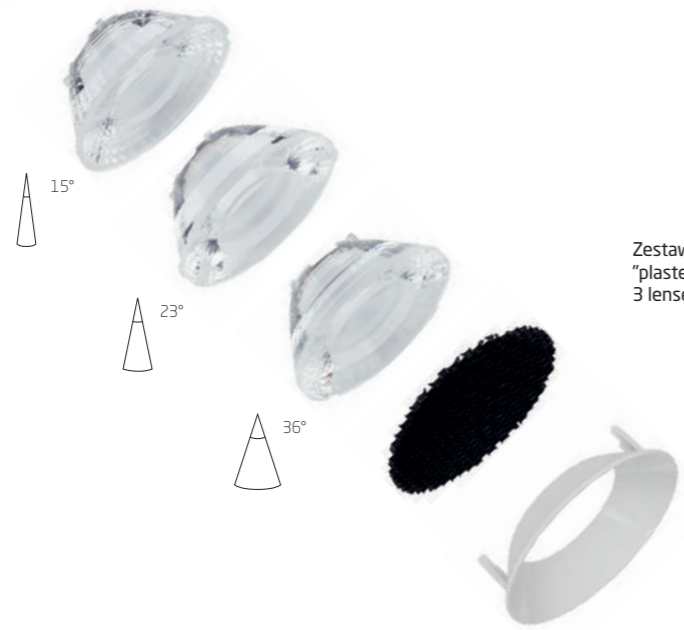

Zestaw zawiera 3 soczewki i filtr przeciwośnieniowy "plaster miodu"
3 lenses and anti-glare "honeycomb" included

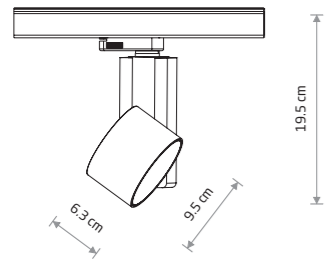

CTLS NEA LED 20W

zinc aluminum alloy

8757 3000K 8756 4000K



CTLS NEA LED 30W
8752



Zestaw zawiera 3 soczewki i filtr przeciwośnieniowy "plaster miodu"
3 lenses and anti-glare "honeycomb" included

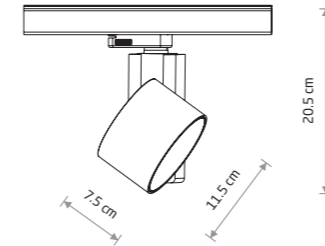

CTLS NEA LED 30W

zinc aluminum alloy

8752 4000K



Item No.	Power	Colour temp.	Luminous flux	Beam angle	Colour Rendering Index (CRI)	Ingress protection	LED brand	Driver brand	Lifetime	Warranty
8757	20W LED	3000K	1600 lm	15/23/36°	≥ 90	IP20	Samsung	Ostram	50000h	5 years
8756	20W LED	4000K	1600 lm	15/23/36°	≥ 90	IP20	Samsung	Ostram	50000h	5 years

Item No.	Power	Colour temp.	Luminous flux	Beam angle	Colour Rendering Index (CRI)	Ingress protection	LED brand	Driver brand	Lifetime	Warranty
8752	30W LED	4000K	2600 lm	20/25/37°	≥ 90	IP20	Samsung	Ostram	50000h	5 years



CTLS NEA LED 40W 8747

Zestaw zawiera 3 soczewki i filtr przeciwośnieniowy "plaster miodu"
3 lenses and anti-glare "honeycomb" included

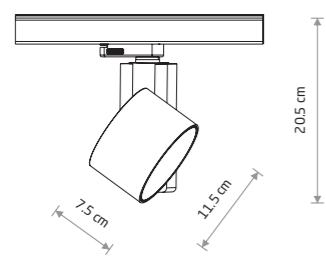

CTLS NEA LED 40W

zinc aluminum alloy

8747 4000K



CTLS NEA LED 40W 8747

Item No.	Power	Colour temp.	Luminous flux	Beam angle	Colour Rendering Index (CRI)	Ingress protection	LED brand	Driver brand	Lifetime	Warranty
8747	40W LED	4000K	3600 lm	20/25/37°	≥ 90	IP20	Samsung	Ostram	50000h	5 years

WHITE



CTLS TINOS LED 10W
10396



CTLS TINOS LED 20W
10391



CTLS TINOS LED 30W
10398

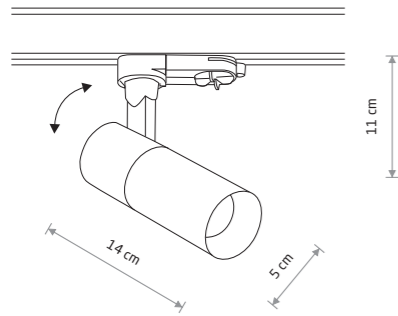

CTLS TINOS LED 10W

Painted aluminum, plastic

- 10390 3000K 10393 4000K
- 10396 3000K 10399 4000K

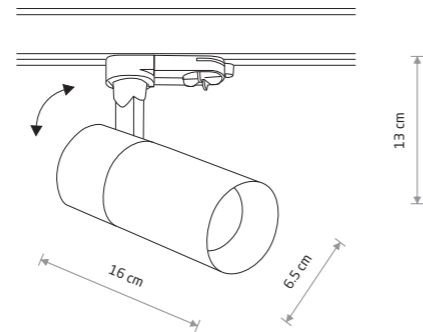

CTLS TINOS LED 20W

Painted aluminum, plastic

- 10391 3000K 10394 4000K
- 10397 3000K 10400 4000K

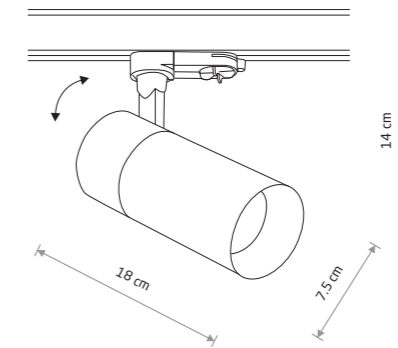

CTLS TINOS LED 30W

Painted aluminum, plastic

- 10398 3000K 10401 4000K
- 10395 4000K

Item No.	Power	Colour temp.	Luminous flux	Beam angle	Colour Rendering Index (CRI)	Input	Safety type	Power factor	Ingress protection	Lifetime
10390	10W LED	3000K	950 lm	36°	>80	~220-230 V, 50/60 Hz	⊕	>0.9	IP20	30000h
10393	10W LED	4000K	1000 lm	36°	>80	~220-230 V, 50/60 Hz	⊕	>0.9	IP20	30000h
10396	10W LED	3000K	880 lm	36°	>80	~220-230 V, 50/60 Hz	⊕	>0.9	IP20	30000h
10399	10W LED	4000K	980 lm	36°	>80	~220-230 V, 50/60 Hz	⊕	>0.9	IP20	30000h
10391	20W LED	3000K	1800 lm	36°	>80	~220-230 V, 50/60 Hz	⊕	>0.9	IP20	30000h
10394	20W LED	4000K	2000 lm	36°	>80	~220-230 V, 50/60 Hz	⊕	>0.9	IP20	30000h
10397	20W LED	3000K	1700 lm	36°	>80	~220-230 V, 50/60 Hz	⊕	>0.9	IP20	30000h
10400	20W LED	4000K	1900 lm	36°	>80	~220-230 V, 50/60 Hz	⊕	>0.9	IP20	30000h

Item No.	Power	Colour temp.	Luminous flux	Beam angle	Colour Rendering Index (CRI)	Input	Safety type	Power factor	Ingress protection	Lifetime
10398	30W LED	3000K	2600 lm	36°	>80	~220-230 V, 50/60 Hz	⊕	>0.9	IP20	30000h
10401	30W LED	4000K	2900 lm	36°	>80	~220-230 V, 50/60 Hz	⊕	>0.9	IP20	30000h
10395	30W LED	4000K	3000 lm	36°	>80	~220-230 V, 50/60 Hz	⊕	>0.9	IP20	30000h

WHITE BLACK

WHITE BLACK

CTLS SNOWBALL
11296

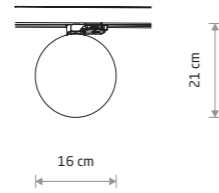

CTLS SNOWBALL
plastic PC, glass, painted steel

■ 11296

● 1xG9, max 12W only LED

● BULB LED G9, 4W

□ 7503 3000K □ 7504 4000K

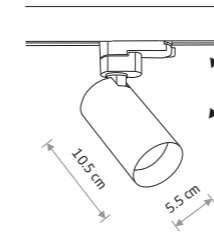

CTLS MONO
painted steel, plastic ABS

■ 10235 □ 10236

■ 10238 ■ 10239

● 1xGU10 R50, max 10W only LED

solid brass, plastic ABS

■ 10237

● 1xGU10 R50, max 10W only LED

CTLS MONO 10239



CTLS SNOWBALL
11295

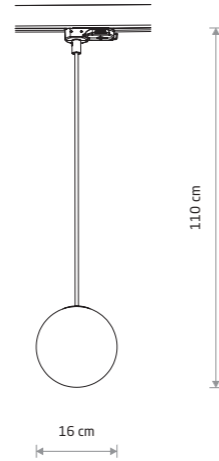
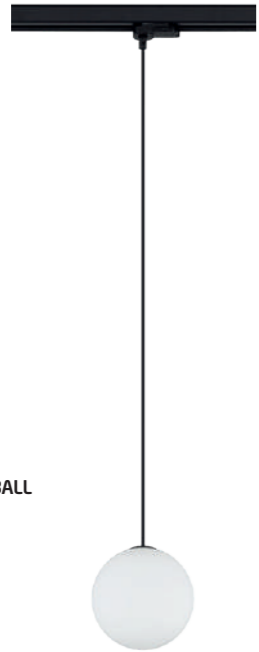

CTLS SNOWBALL
plastic PC, glass, painted steel

■ 11295

● 1xG9, max 12W only LED

● BULB LED G9, 4W

□ 7503 3000K □ 7504 4000K

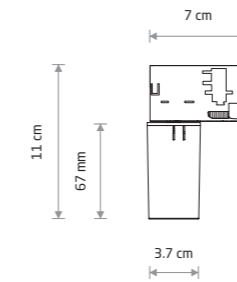

CAMELEON ADAPTER
CTLS
plastic

■ 8281 □ 8282

CAMELEON ADAPTER CTLS
8281



CTLS - COMMERCIAL TRACK LIGHT SYSTEM, 3 CIRCUIT

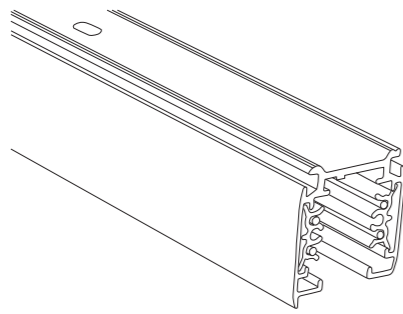

1 CTLS TRACK 3 CIRCUIT 1M

aluminum

8715 8714

2 CTLS TRACK 3 CIRCUIT 2M

aluminum

8717 8716

Sposoby montażu / Installation methods

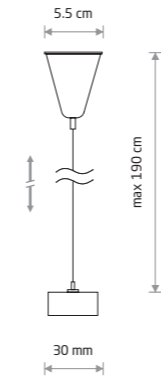

3 CTLS SUSPENSION KIT 3 CIRCUIT

plastic, steel

8696 8697

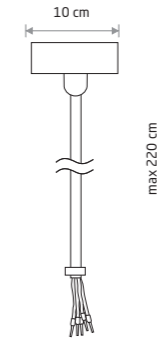

4 CTLS POWER SUPPLY KIT 3 CIRCUIT

painted steel, painted steel, plastic

8284 8283

1. Zwieszenie na linkach
1. Suspended on steel wires

Schematy zasilania / Power supply circuit diagrams

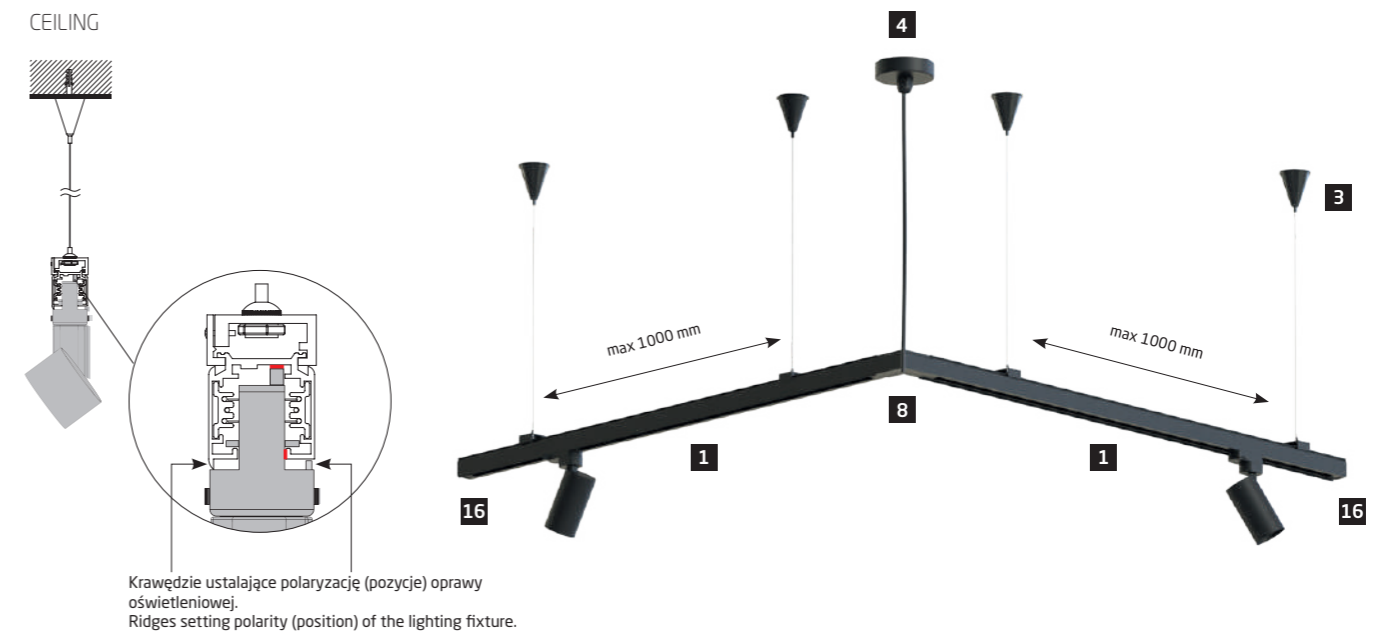
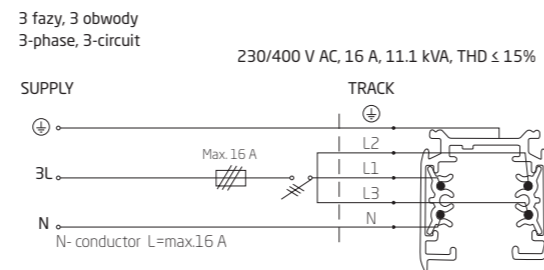
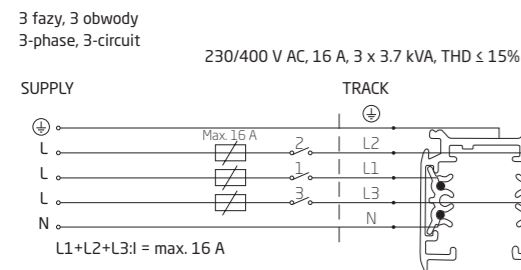
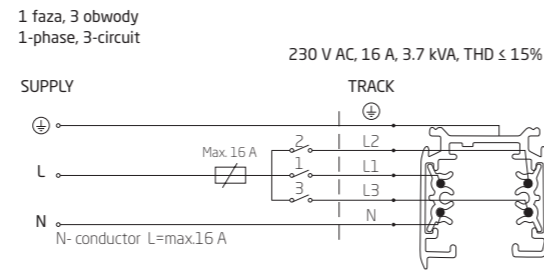
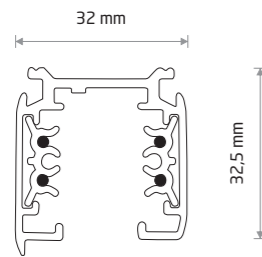

2. Montaż bezpośredni
2. Surface mounting



Maksymalna długość systemu szynoprzewodowego - 100 m.
Zalecany dystans pomiędzy mocowaniami max. 1000 mm.
System szynoprzewodowy (CTLS) należy równomiernie obciążyć elektrycznie oraz równomiernie rozmieścić oprawy na jego długości.

Maximum length of track lights system - 100 m.
The recommended fastening distance is max. 1000 mm.
The track light system (CTLS) should be evenly electrically loaded and the fittings should be evenly placed along its length.

WHITE BLACK

WHITE BLACK

CTLS - POLARITY IN COMMERCIAL TRACK LIGHT SYSTEM

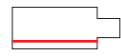
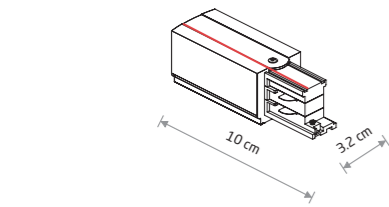
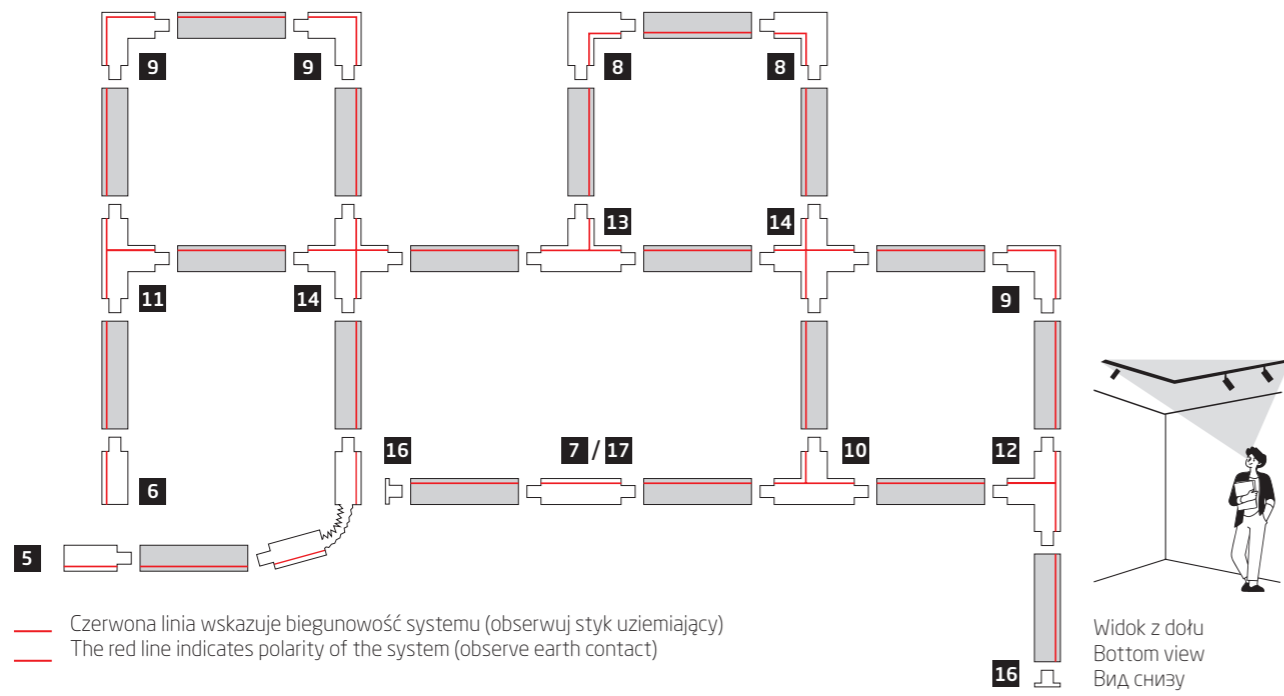

5 CTLS POWER END CAP, RIGHT (PE-R)
 plastic, copper
 8712 8713

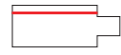
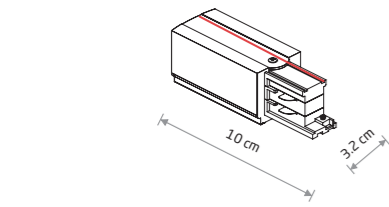

6 CTLS POWER END CAP, LEFT (PE-L)
 plastic, copper
 8232 8233

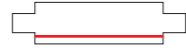
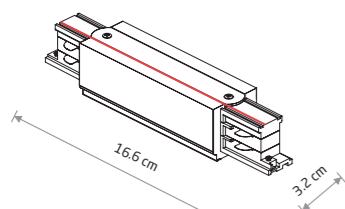

7 CTLS POWER STRAIGHT CONNECTOR
 plastic, copper
 8707 8708

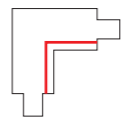
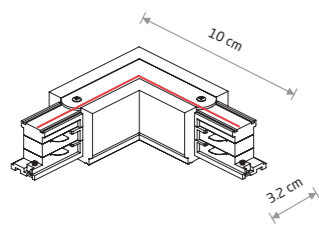

8 CTLS POWER L CONNECTOR, RIGHT (L-R)
 plastic, copper
 8227 8228

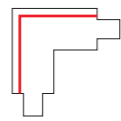
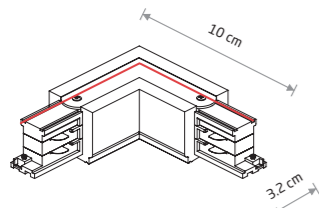

9 CTLS POWER L CONNECTOR, LEFT (L-L)
 plastic, copper
 8705 8706

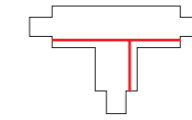
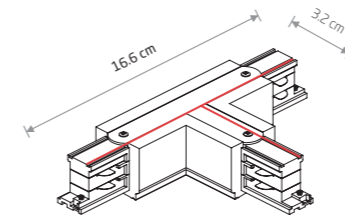

10 CTLS POWER T CONNECTOR, LEFT 2 (T-L2)
 plastic, copper
 8236 8237

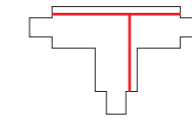
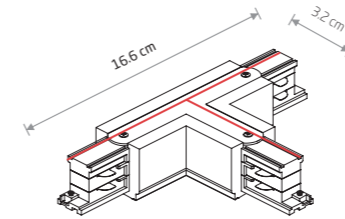

11 CTLS POWER T CONNECTOR, LEFT 1 (T-L1)
 plastic, copper
 8243 8244

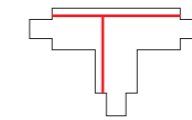
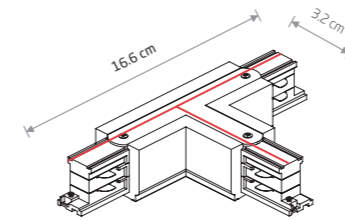

12 CTLS POWER T CONNECTOR, RIGHT 2 (T-R2)
 plastic, copper
 8703 8704

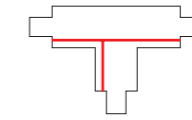
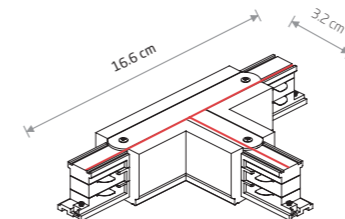

13 CTLS POWER T CONNECTOR, RIGHT 1 (T-R1)
 plastic, copper
 8241 8242

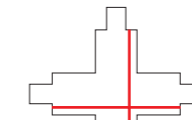
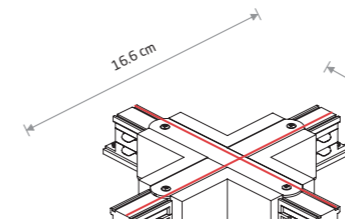

14 CTLS POWER X CONNECTOR
 plastic, copper
 8701 8702

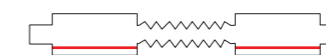
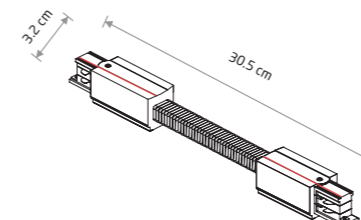

15 CTLS POWER FLEX CONNECTOR
 plastic, copper
 8698 8700

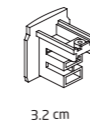

16 CTLS DEAD END CAP
 plastic
 8710 8711

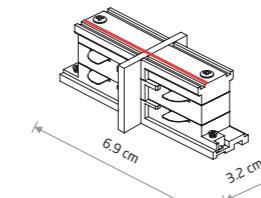

17 CTLS STRAIGHT CONNECTOR MINI
 plastic, copper
 8085 8084

CTLS - RECESSED COMMERCIAL TRACK LIGHT SYSTEM, 3 CIRCUIT

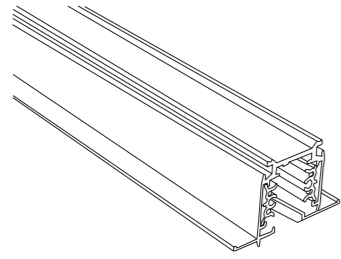

1 CTLS RECESSED TRACK 3 CIRCUIT 1M

aluminum

8693 8692

2 CTLS RECESSED TRACK 3 CIRCUIT 2M

aluminum

8695 8694

Schematy zasilania / Power supply circuit diagrams

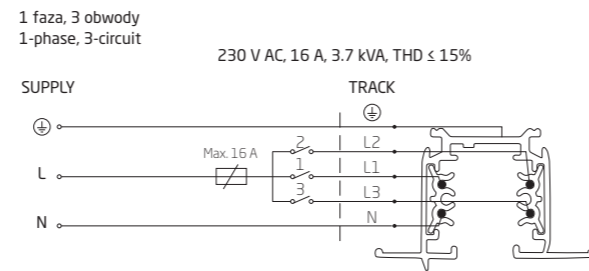
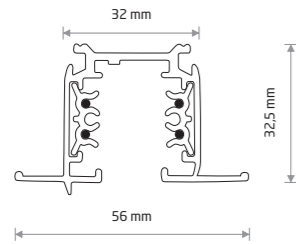

3 fazy, 3 obwody
3-phase, 3-circuit

230/400 V AC, 16 A, 3 x 3.7 kVA, THD ≤ 15%

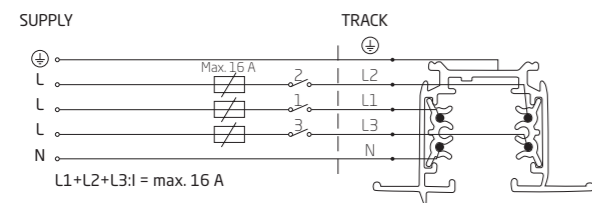

3 fazy, 3 obwody
3-phase, 3-circuit

230/400 V AC, 16 A, 11.1 kVA, THD ≤ 15%

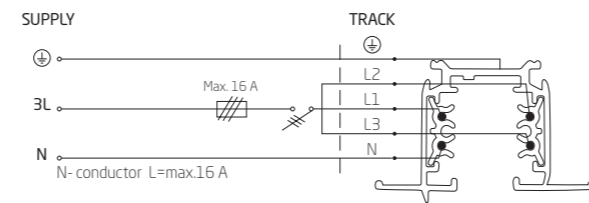

Maksymalna długość systemu szynoprzewodowego - 100 m.
Zalecany dystans pomiędzy mocowaniami max. 1000 mm.
System szynoprzewodowy (CTLS) należy równomiernie obciążyć elektrycznie oraz równomiernie rozmieścić oprawy na jego długości.

Maximum length of track lights system - 100 m.
The recommended fastening distance is max. 1000 mm.
The track light system (CTLS) should be evenly electrically loaded and the fittings should be evenly placed along its length.

Sposób montażu / Installation method

- 1. Montaż podtynkowy
- 1. Recessed mounting

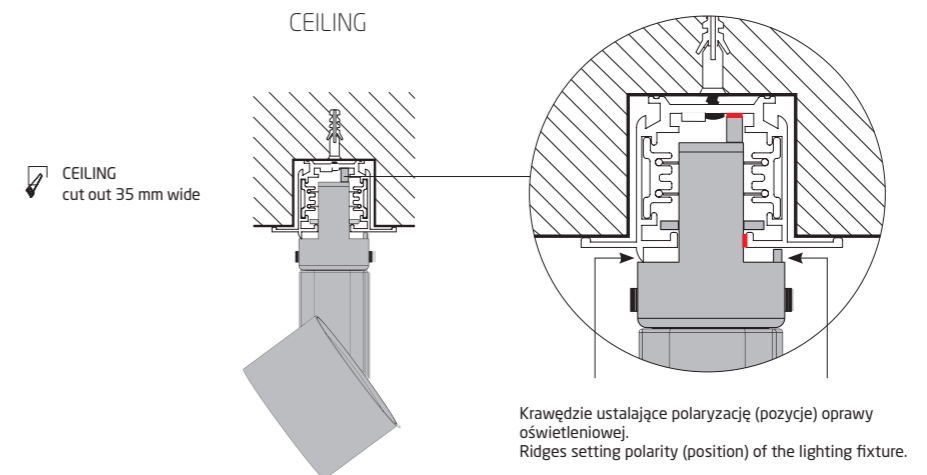
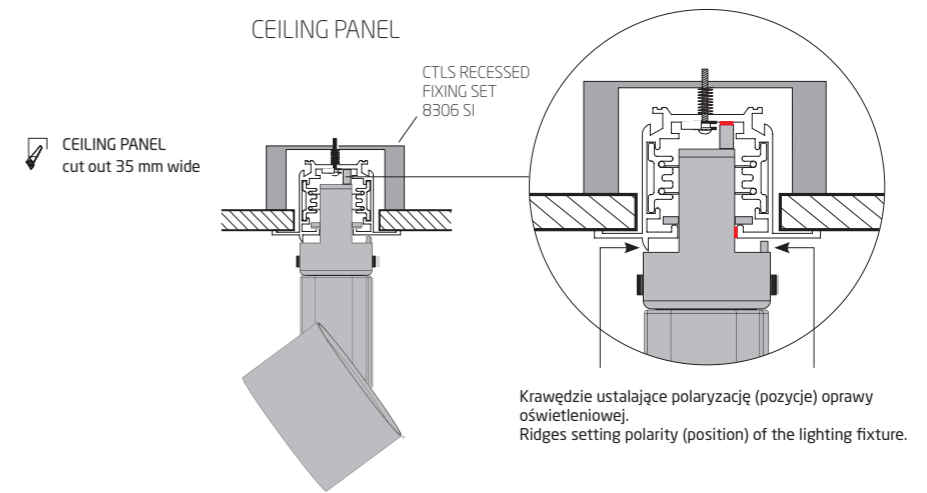

CTLS - POLARITY IN RECESSED COMMERCIAL TRACK LIGHT SYSTEM

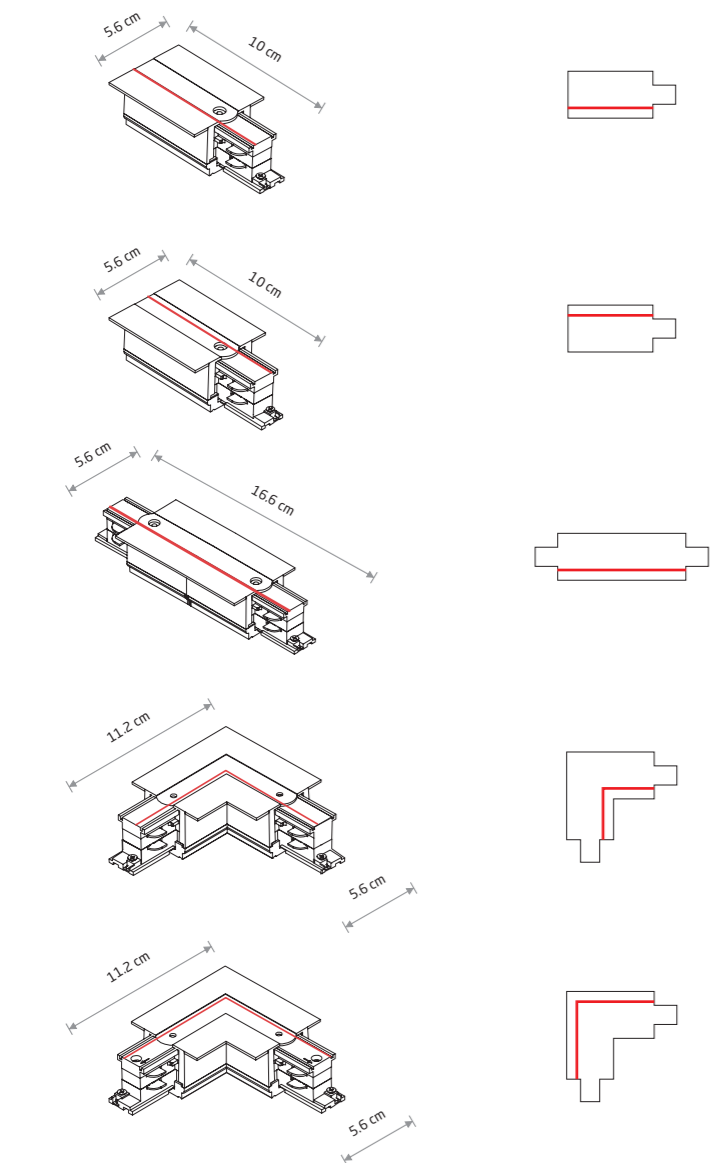
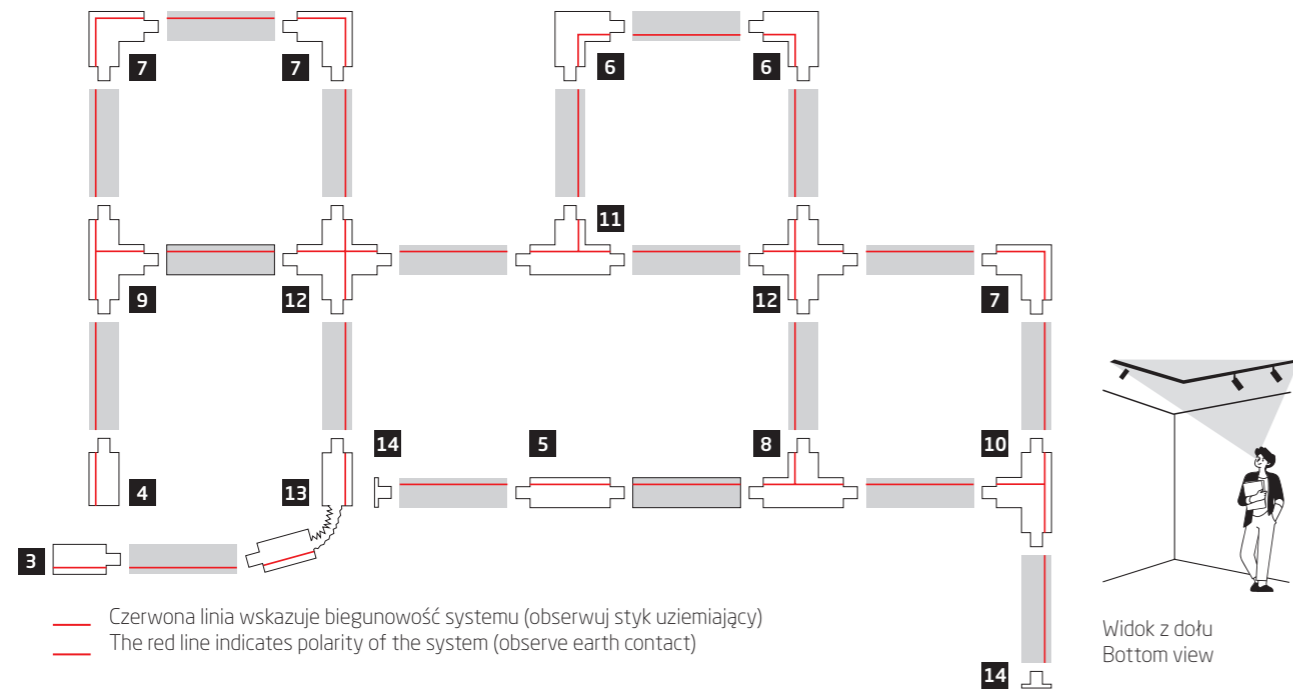

3 CTLS RECESSED POWER END CAP, RIGHT (PE-R)
 plastic, copper

8691 8690

4 CTLS RECESSED POWER END CAP, LEFT (PE-L)
 plastic, copper

8234 8235

5 CTLS RECESSED POWER STRAIGHT CONNECTOR
 plastic, copper

8686 8685

6 CTLS RECESSED POWER L CONNECTOR, RIGHT (L-R)
 plastic, copper

8230 8231

7 CTLS RECESSED POWER L CONNECTOR, LEFT (L-L)
 plastic, copper

8684 8683

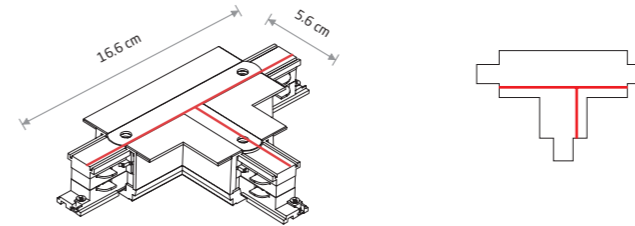

8 CTLS RECESSED POWER T CONNECTOR, LEFT 2 (T-L2)
 plastic, copper

8238 8240

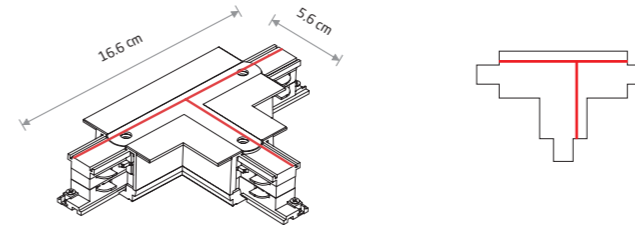

9 CTLS RECESSED POWER T CONNECTOR, LEFT 1 (T-L1)
 plastic, copper

8247 8248

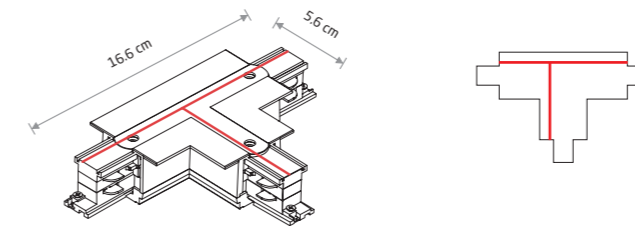

10 CTLS RECESSED POWER T CONNECTOR, RIGHT 2 (T-R2)
 plastic, copper

8681 8682

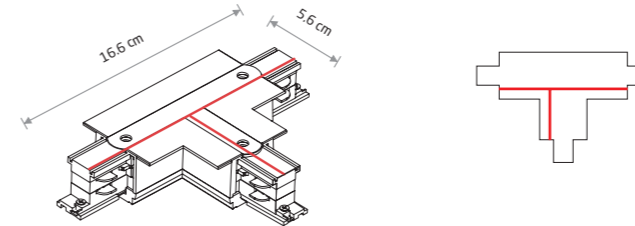

11 CTLS RECESSED POWER T CONNECTOR, RIGHT 1 (T-R1)
 plastic, copper

8245 8246

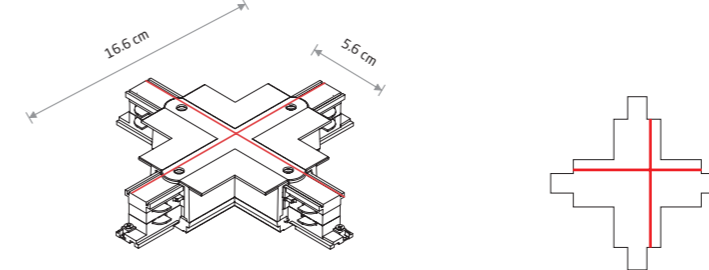

12 CTLS RECESSED POWER X CONNECTOR
 plastic, copper

8678 8680

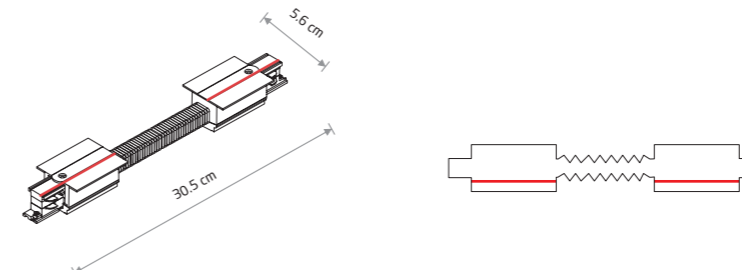

13 CTLS RECESSED POWER FLEX CONNECTOR
 plastic, copper

8676 8677



14 CTLS RECESSED DEAD END CAP
 plastic

8688 8687



15 CTLS RECESSED FIXING SET
 steel

8306

WHITE BLACK

SILVER WHITE BLACK



Profile Track Light System



PROFILE TINOS LED 7W 10385



PROFILE TINOS LED 10W 10373



PROFILE TINOS LED 20W 10383



PROFILE TINOS LED 30W 10375

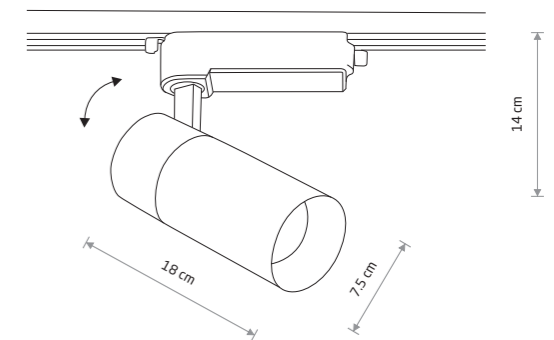
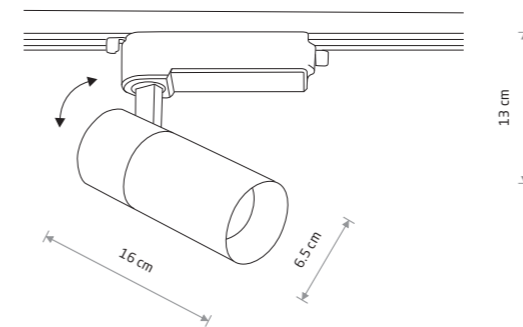
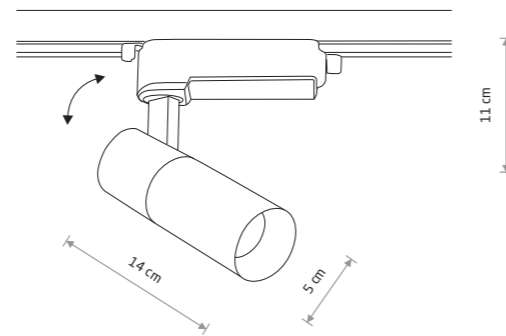
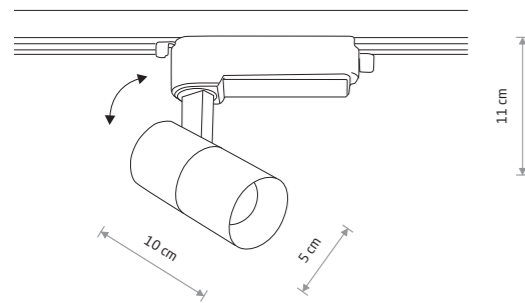

PROFILE TINOS LED 7W

Painted aluminum, plastic

- 10372 3000K 10376 4000K
- 10381 3000K 10385 4000K



PROFILE TINOS LED 10W

Painted aluminum, plastic

- 10373 3000K 10377 4000K
- 10382 3000K 10386 4000K



PROFILE TINOS LED 20W

Painted aluminum, plastic

- 10374 3000K 10378 4000K
- 10383 3000K 10387 4000K



PROFILE TINOS LED 30W

Painted aluminum, plastic

- 10375 3000K 10380 4000K
- 10384 3000K 10388 4000K



Item No.	Power	Colour temp.	Luminous flux	Beam angle	Colour Rendering Index (CRI)	Input	Safety type	Power factor	Ingress protection	Lifetime
10372	7W LED	3000K	550 lm	36°	>80	~220-230 V, 50/60 Hz	☐	>0.9	IP20	30000h
10376	7W LED	4000K	570 lm	36°	>80	~220-230 V, 50/60 Hz	☐	>0.9	IP20	30000h
10381	7W LED	3000K	530 lm	36°	>80	~220-230 V, 50/60 Hz	☐	>0.9	IP20	30000h
10385	7W LED	4000K	550 lm	36°	>80	~220-230 V, 50/60 Hz	☐	>0.9	IP20	30000h
10373	10W LED	3000K	950 lm	36°	>80	~220-230 V, 50/60 Hz	☐	>0.9	IP20	30000h
10377	10W LED	4000K	1000 lm	36°	>80	~220-230 V, 50/60 Hz	☐	>0.9	IP20	30000h
10382	10W LED	3000K	880 lm	36°	>80	~220-230 V, 50/60 Hz	☐	>0.9	IP20	30000h
10386	10W LED	4000K	980 lm	36°	>80	~220-230 V, 50/60 Hz	☐	>0.9	IP20	30000h

Item No.	Power	Colour temp.	Luminous flux	Beam angle	Colour Rendering Index (CRI)	Input	Safety type	Power factor	Ingress protection	Lifetime
10374	20W LED	3000K	1800 lm	36°	>80	~220-230 V, 50/60 Hz	☐	>0.9	IP20	30000h
10378	20W LED	4000K	2000 lm	36°	>80	~220-230 V, 50/60 Hz	☐	>0.9	IP20	30000h
10383	20W LED	3000K	1700 lm	36°	>80	~220-230 V, 50/60 Hz	☐	>0.9	IP20	30000h
10387	20W LED	4000K	1900 lm	36°	>80	~220-230 V, 50/60 Hz	☐	>0.9	IP20	30000h
10375	30W LED	3000K	2800 lm	36°	>80	~220-230 V, 50/60 Hz	☐	>0.9	IP20	30000h
10380	30W LED	4000K	3000 lm	36°	>80	~220-230 V, 50/60 Hz	☐	>0.9	IP20	30000h
10384	30W LED	3000K	2600 lm	36°	>80	~220-230 V, 50/60 Hz	☐	>0.9	IP20	30000h
10388	30W LED	4000K	2900 lm	36°	>80	~220-230 V, 50/60 Hz	☐	>0.9	IP20	30000h

☐ WHITE ■ BLACK

☐ WHITE ■ BLACK



PROFILE IRIS LED 7W 8996

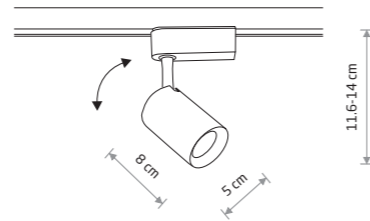

PROFILE IRIS LED 7W

painting aluminum, plastic PC

8995 3000K 8997 4000K

8996 3000K 8998 4000K



PROFILE IRIS LED 20W 9005

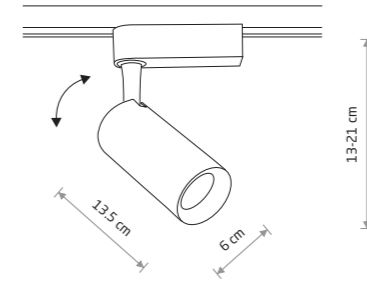

PROFILE IRIS LED 12W 9002

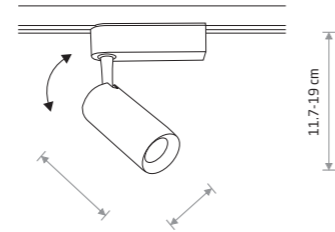

PROFILE IRIS LED 12W

painting aluminum, plastic PC

9000 3000K 9002 4000K

9001 3000K 9003 4000K



PROFILE IRIS LED 20W

painting aluminum, plastic PC

9004 3000K 9006 4000K

9005 3000K 9007 4000K



Item No.	Power	Colour temp.	Luminous flux	Beam angle	Colour Rendering Index (CRI)	Input	Safety type	Power factor	Ingress protection	Lifetime
8995	7W LED	3000K	550 lm	30°	>80	~220-230 V, 50/60 Hz	☐	>0.5	IP20	30000h
8996	7W LED	3000K	530 lm	30°	>80	~220-230 V, 50/60 Hz	☐	>0.5	IP20	30000h
8997	7W LED	4000K	560 lm	30°	>80	~220-230 V, 50/60 Hz	☐	>0.5	IP20	30000h
8998	7W LED	4000K	550 lm	30°	>80	~220-230 V, 50/60 Hz	☐	>0.5	IP20	30000h
9000	12W LED	3000K	1000 lm	30°	>80	~220-230 V, 50/60 Hz	☐	>0.5	IP20	30000h
9001	12W LED	3000K	950 lm	30°	>80	~220-230 V, 50/60 Hz	☐	>0.5	IP20	30000h
9002	12W LED	4000K	1100 lm	30°	>80	~220-230 V, 50/60 Hz	☐	>0.5	IP20	30000h
9003	12W LED	4000K	1000 lm	30°	>80	~220-230 V, 50/60 Hz	☐	>0.5	IP20	30000h

Item No.	Power	Colour temp.	Luminous flux	Beam angle	Colour Rendering Index (CRI)	Input	Safety type	Power factor	Ingress protection	Lifetime
9004	20W LED	3000K	1500 lm	30°	>80	~220-230 V, 50/60 Hz	☐	>0.5	IP20	30000h
9005	20W LED	3000K	1400 lm	30°	>80	~220-230 V, 50/60 Hz	☐	>0.5	IP20	30000h
9006	20W LED	4000K	1600 lm	30°	>80	~220-230 V, 50/60 Hz	☐	>0.5	IP20	30000h
9007	20W LED	4000K	1500 lm	30°	>80	~220-230 V, 50/60 Hz	☐	>0.5	IP20	30000h

☐ WHITE ■ BLACK

☐ WHITE ■ BLACK



PROFILE MIKE 7661

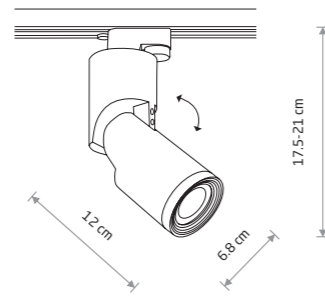

PROFILE MIKE

painting aluminum, plastic

■ 7661

☛ 1xGU10 R50, max 15W only LED



PROFILE ZOOM LED 7625



PROFILE INDIA 7657

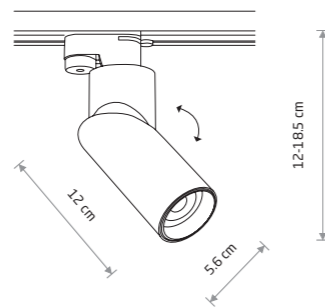

PROFILE INDIA

painting aluminum, plastic

■ 7657

☛ 1xGU10 R50, max 15W only LED

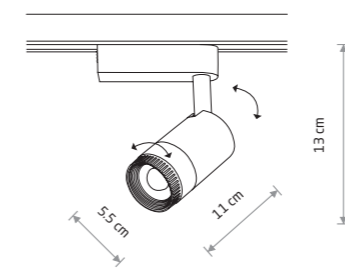

PROFILE ZOOM LED

painting aluminum, plastic

□ 7623 3000K □ 7624 4000K

■ 7625 3000K ■ 7626 4000K



BEAM CONE

BEAM ANGLE 15°



BEAM ANGLE 50°



PROFILE FOCUS LED 7621

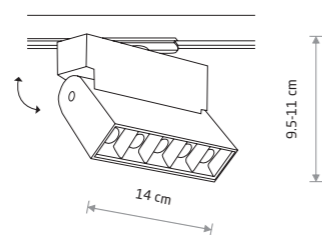

PROFILE FOCUS LED

painting aluminum, plastic

□ 7618 3000K □ 7620 4000K

■ 7621 3000K ■ 7622 4000K



Item No.	Power	Colour temp.	Luminous flux	Beam angle	Colour Rendering Index (CRI)	Input	Safety type	Power factor	Ingress protection
7618	10W LED	3000K	600 lm	36°	>90	~220-230 V, 50/60 Hz	☐	>0.9	IP20
7620	10W LED	4000K	600 lm	36°	>90	~220-230 V, 50/60 Hz	☐	>0.9	IP20
7621	10W LED	3000K	600 lm	36°	>90	~220-230 V, 50/60 Hz	☐	>0.9	IP20
7622	10W LED	4000K	600 lm	36°	>90	~220-230 V, 50/60 Hz	☐	>0.9	IP20
7623	9W LED	3000K	600 lm	15-50°	>90	~220-230 V, 50/60 Hz	☐	>0.9	IP20
7624	9W LED	4000K	660 lm	15-50°	>90	~220-230 V, 50/60 Hz	☐	>0.9	IP20
7625	9W LED	3000K	600 lm	15-50°	>90	~220-230 V, 50/60 Hz	☐	>0.9	IP20
7626	9W LED	4000K	660 lm	15-50°	>90	~220-230 V, 50/60 Hz	☐	>0.9	IP20



PROFILE EYE SUPER C 9244

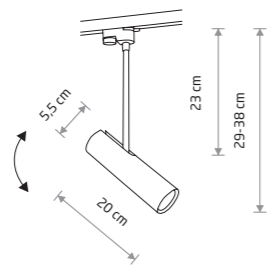

PROFILE EYE SUPER C

painting steel, plastic PC

9245 9244

1xGU10 R50, max 10W only LED

PROFILE BIT PLUS

painting steel, plastic PC

9018

1xGU10 ES111, max 15W only LED

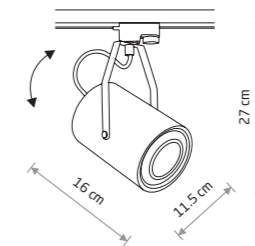

PROFILE BIT PLUS 9018



PROFILE EYE SUPER A 9325

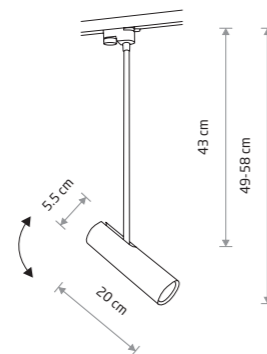

PROFILE EYE SUPER A

painting steel, plastic PC

9324 9325

1xGU10 R50, max 10W only LED

PROFILE BIT

painting steel, plastic PC

8823

1xGU10 ES111, max 15W only LED

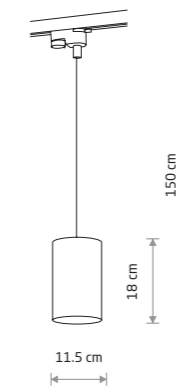

PROFILE BIT 8823

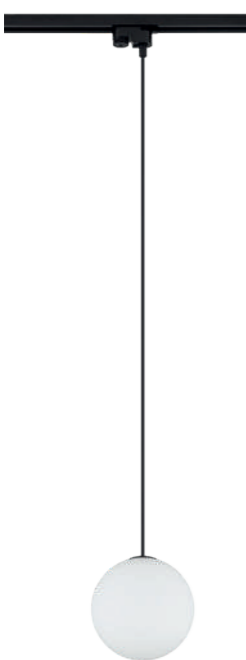

PROFILE SNOWBALL 11297

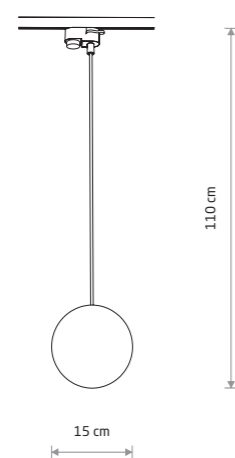

PROFILE SNOWBALL

plastic PC, glass, painting steel

11297

1xG9, max 12W only LED

BULB LED G9, 4W

7503 3000K 7504 4000K

PROFILE EYE

painting steel, plastic PC

9337 9338

1xGU10 R50, max 10W only LED

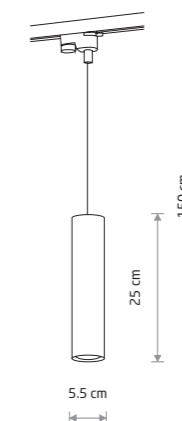

PROFILE EYE 9338



PROFILE EYE SPOT 9322

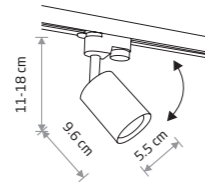

PROFILE EYE SPOT

painted steel, plastic PC, chrome

9321 9322

1xGU10 R50, max 10W only LED

PROFILE SNOWBALL

plastic PC, glass, painted steel

11298

1xG9, max 12W only LED

BULB LED G9, 4W

7503 3000K 7504 4000K

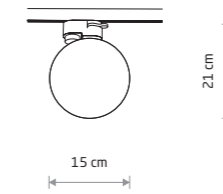

PROFILE SNOWBALL 11298



PROFILE MONO 7583

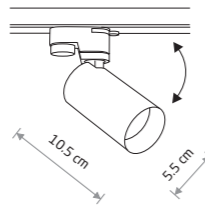

PROFILE MONO

painted steel, plastic ABS

7581 7582

7584 7585

1xGU10 R50, max 10W only LED

solid brass, painted steel, plastic ABS

7583

1xGU10 R50, max 10W only LED

PROFILE VESPA

painted steel, plastic PC, chrome

8824 8825

1xGU10 ES111, max 15W only LED

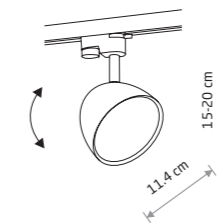

PROFILE VESPA 8825



PROFILE PUCK 10358

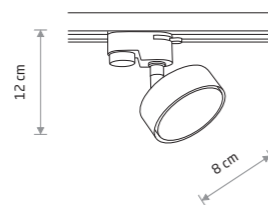

PROFILE PUCK

painted steel, plastic PC

10358

1xGX53, max 12W only LED

CAMELEON ADAPTER PROFILE

plastic

8360 8361

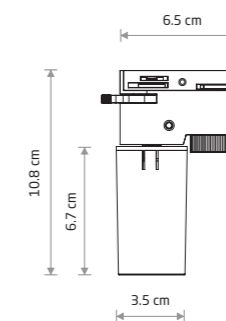

CAMELEON ADAPTER PROFILE 8360



PROFILE TRACK LIGHT SYSTEM

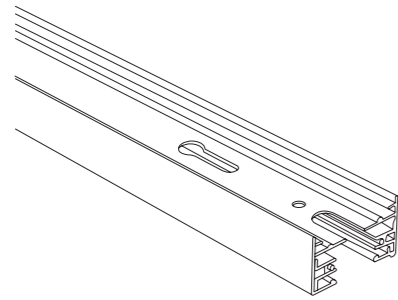

1 PROFILE TRACK 1 M

Painted aluminum

9450 9448

2 PROFILE TRACK 2 M

Painted aluminum

9451 9452

Sposoby montażu / Installation methods

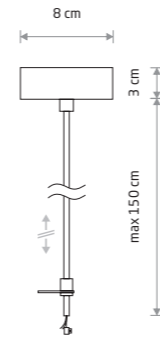

3 PROFILE POWER SUPPLY KIT

Painted steel

9237 9238

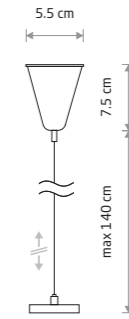

4 PROFILE SUSPENSION KIT

Painted steel, plastic

9461 9460

Schemat zasilania / Power supply circuit diagram

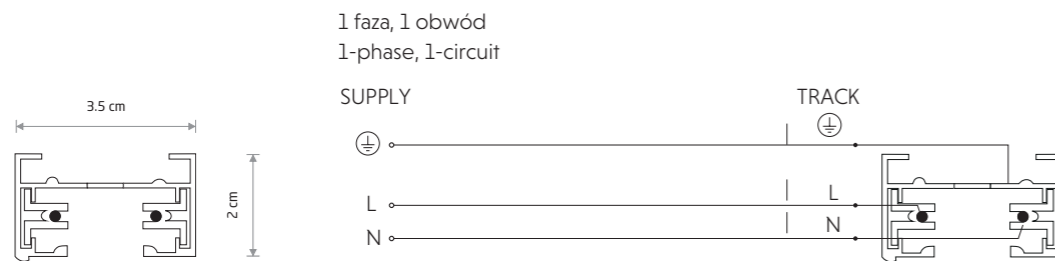

Zalecany dystans pomiędzy mocowaniami max. 1000 mm
Maksymalna długość jednego obwodu systemu szynoprzewodowego PROFILE - 20 m, a maksymalne obciążenie elektryczne - 1500W
System szynoprzewodowy należy równomiernie obciążyć elektrycznie oraz równomiernie rozmieścić oprawy na jego długości.

The recommended fastening distance is max. 1000 mm
The maximum length of one circuit of PROFILE track light system - 20 m, and the maximum circuit power load - 1500W
The track light system should be evenly electrically loaded and the fittings should be evenly placed along its length.

1. Zwieszenie na linkach stalowych 1. Suspended on steel wires

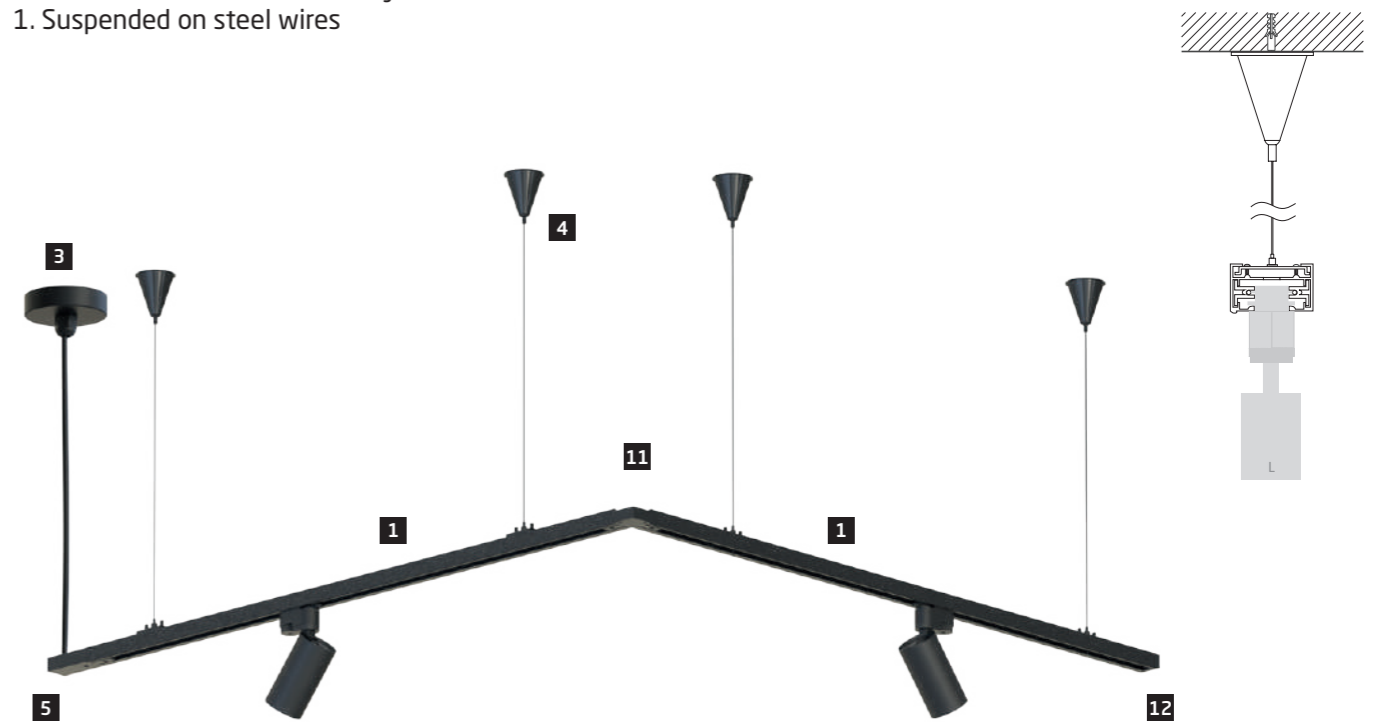

2. Montaż bezpośredni 2. Surface mounting

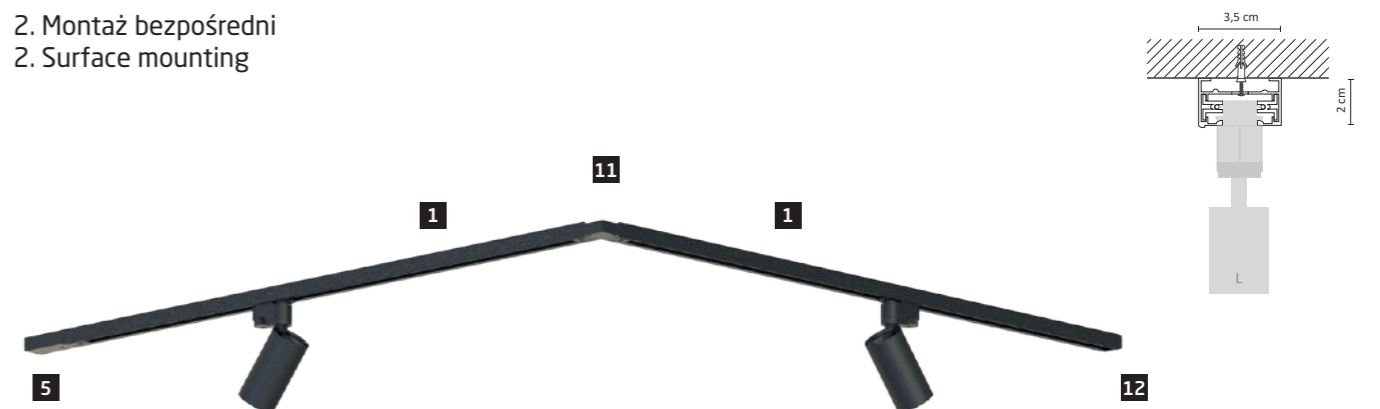

PROFILE TRACK LIGHT SYSTEM

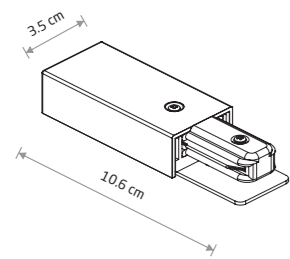
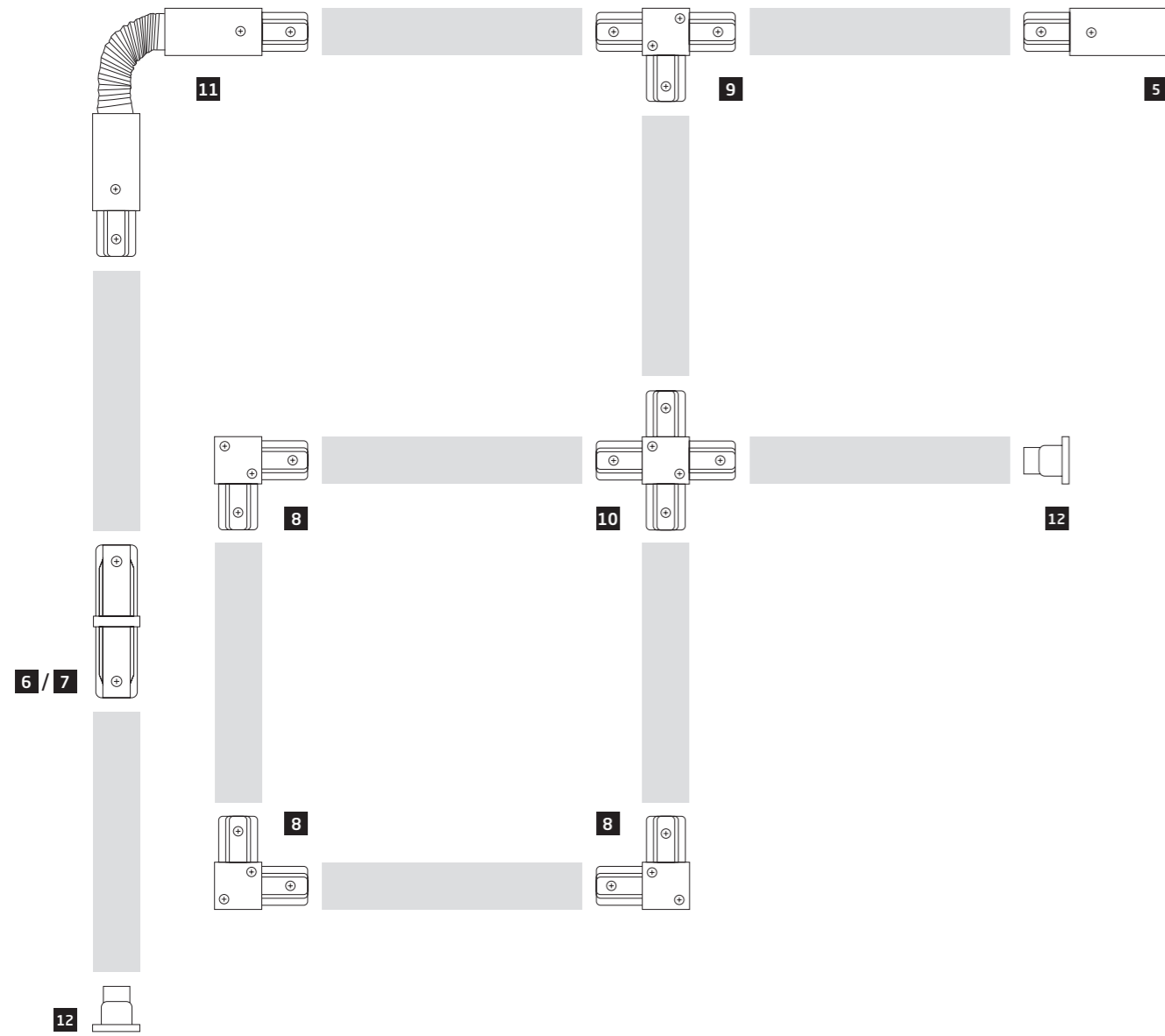

5 PROFILE POWER END CAP

plastic PC, steel, copper

9462 9463

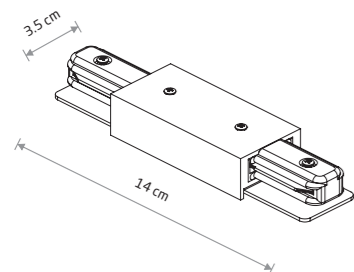

6 PROFILE POWER STRAIGHT CONNECTOR

plastic PC, steel

10225 10226

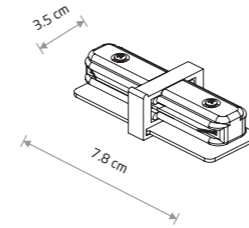

7 PROFILE STRAIGHT CONNECTOR

plastic PC, steel, copper

9454 9453

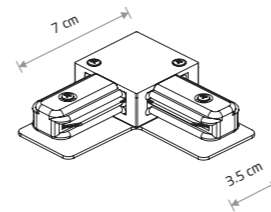

8 PROFILE L CONNECTOR

plastic PC, steel, copper

9456 9455

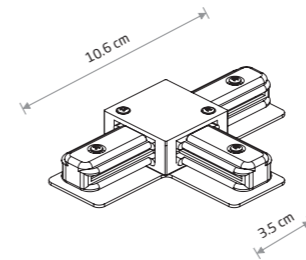

9 PROFILE T CONNECTOR

plastic PC, steel, copper

9187 9186

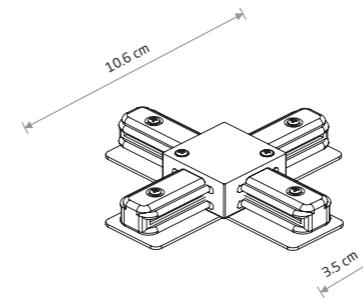

10 PROFILE X CONNECTOR

plastic PC, steel, copper

9190 9188

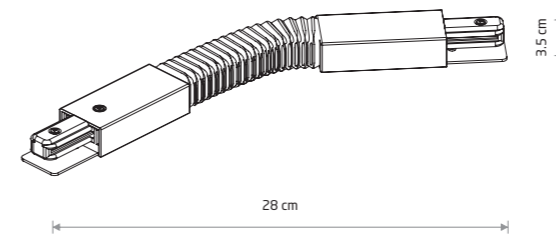

11 PROFILE FLEX CONNECTOR

plastic PC, steel, copper

8382 8383

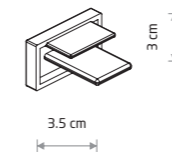

12 PROFILE DEAD END CAP

plastic PC

9457 9458

PROFILE RECESSED TRACK LIGHT SYSTEM

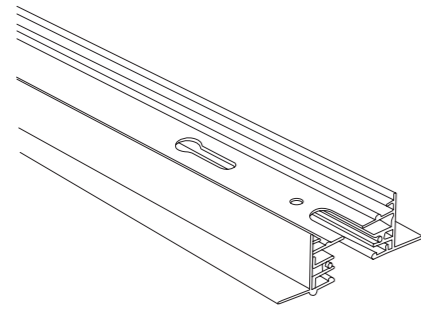

1 PROFILE RECESSED TRACK 1 METER

Painted aluminum

9012 9013

2 PROFILE RECESSED TRACK 2 METERS

Painted aluminum

9014 9015

Schemat zasilania / Power supply circuit diagram

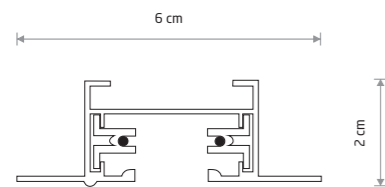

1 faza, 1 obwód
1-phase, 1-circuit

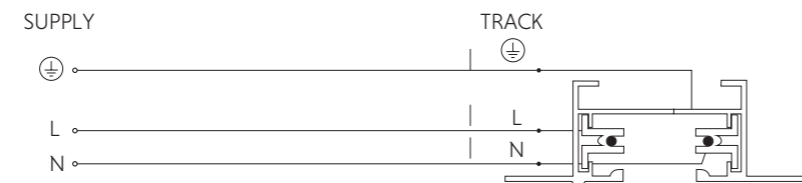

Sposób montażu / Installation method

- 1. Montaż podtynkowy
- 1. Recessed mounting

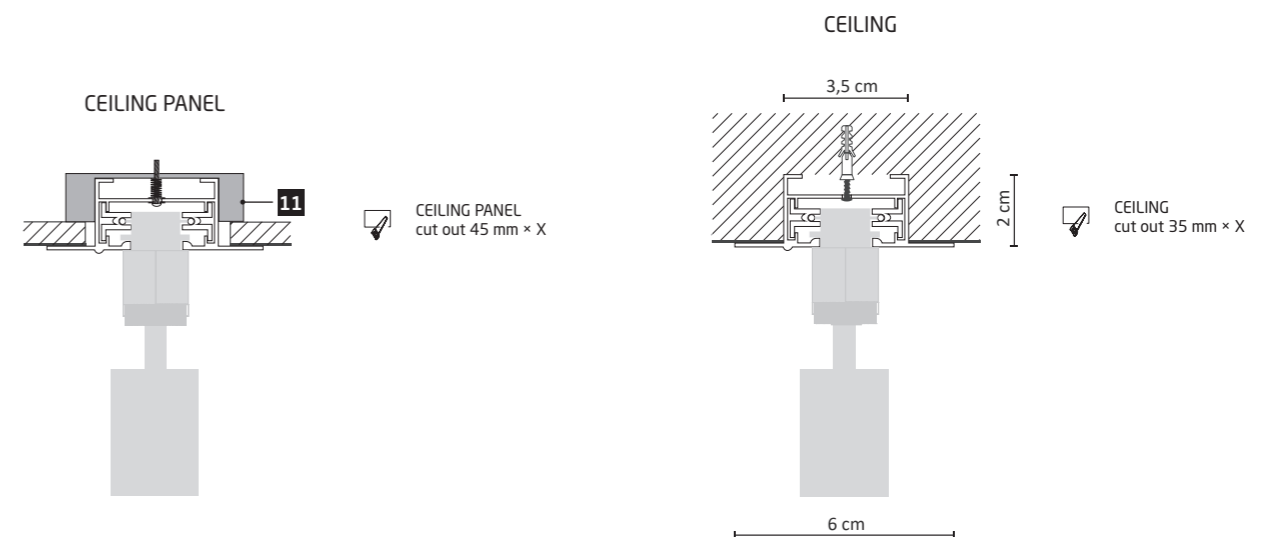
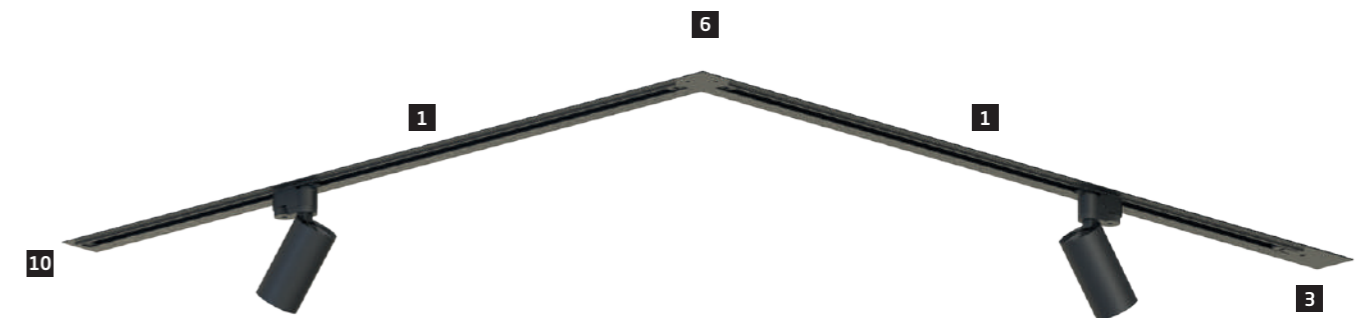

Zalecany dystans pomiędzy mocowaniami max. 1000 mm.
Maksymalna długość jednego obwodu systemu szynoprzewodowego PROFILE - 20 m, a maksymalne obciążenie elektryczne - 1500W.
System szynoprzewodowy należy równomiernie obciążyć elektrycznie oraz równomiernie rozmieścić oprawy na jego długości.

The recommended fastening distance is max. 1000 mm.
The maximum length of one circuit of track light system PROFILE - 20 m, and the maximum circuit power load - 1500W.
The track light system should be evenly electrically loaded and the fittings should be evenly placed along its length.

WHITE BLACK

PROFILE RECESSED TRACK LIGHTS SYSTEM

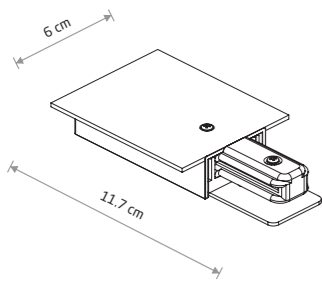
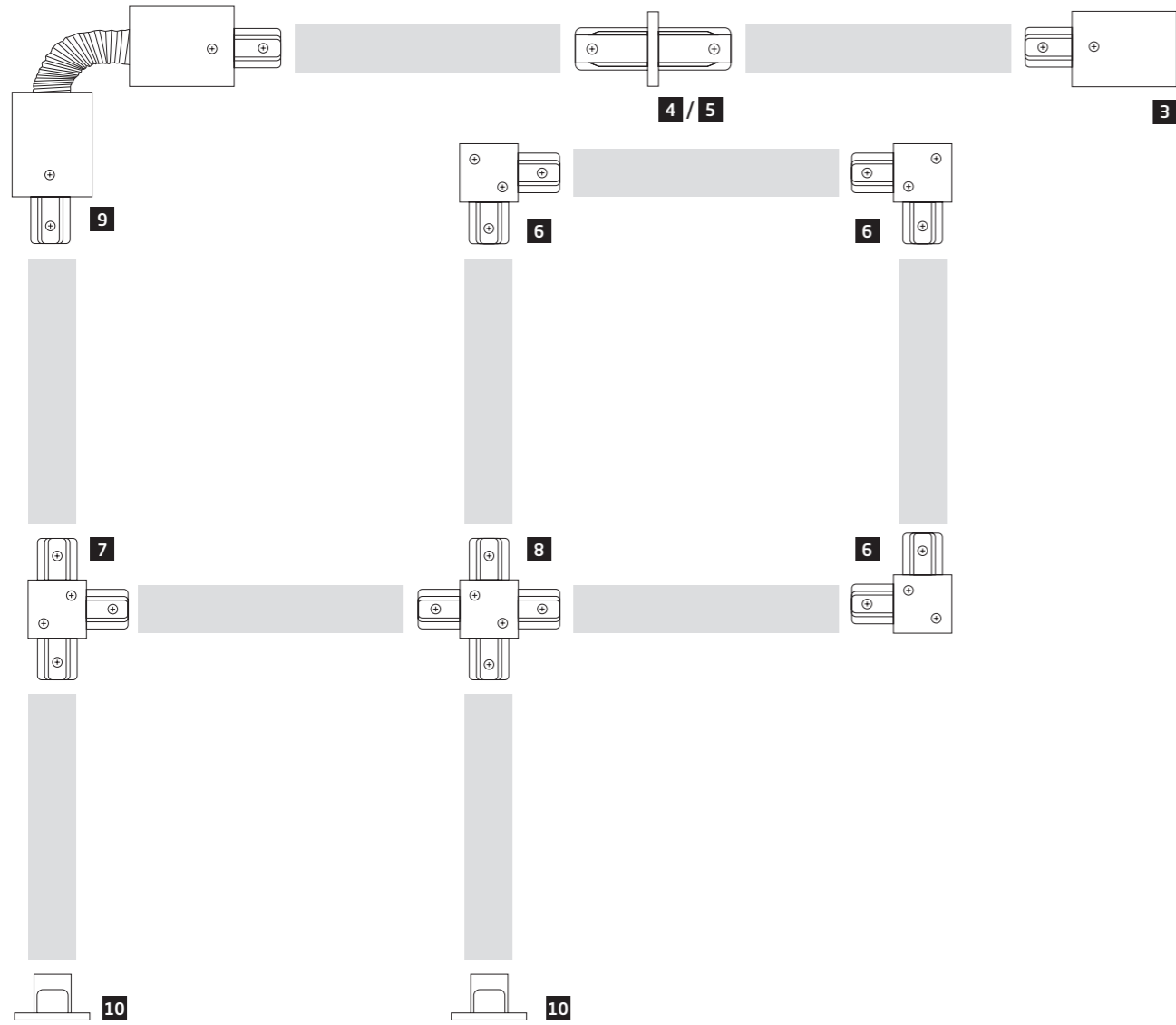

3 PROFILE RECESSED POWER END CAP
plastic PC, steel, copper
□ 8972 ■ 8973

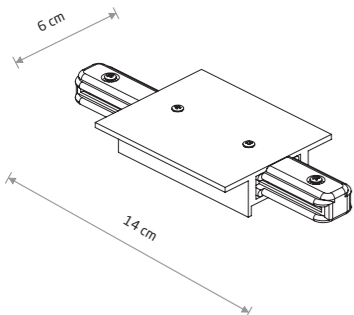

4 PROFILE RECESSED POWER STRAIGHT CONNECTOR
plastic PC, steel
□ 10227 ■ 10228

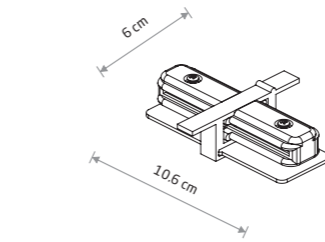

5 PROFILE RECESSED STRAIGHT CONNECTOR
plastic PC, steel, copper
□ 8967 ■ 8968

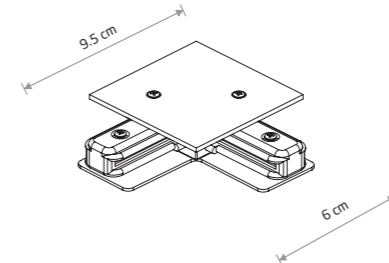

6 PROFILE RECESSED L CONNECTOR
plastic PC, steel, copper
□ 8970 ■ 8971

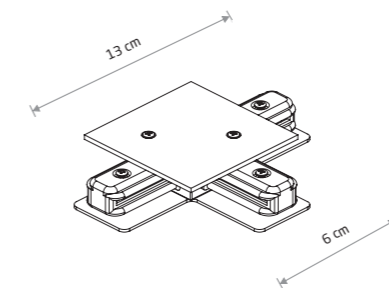

7 PROFILE RECESSED T CONNECTOR
plastic PC, steel, copper
□ 8834 ■ 8835

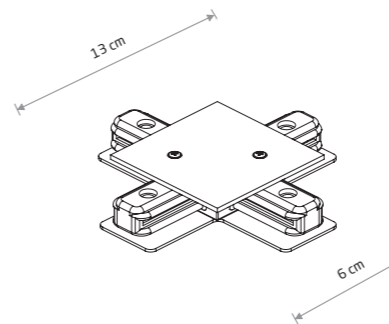

8 PROFILE RECESSED X CONNECTOR
plastic PC, steel, copper
□ 8836 ■ 8837

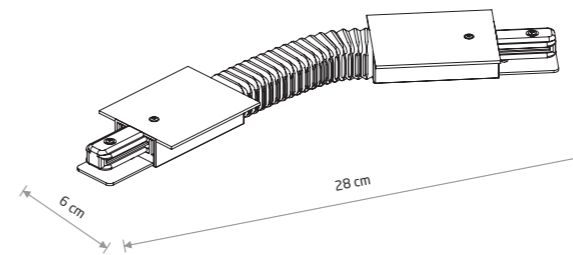

9 PROFILE RECESSED FLEX CONNECTOR
plastic PC, steel, copper
□ 8384 ■ 8385

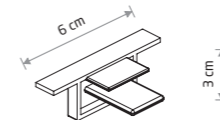

10 PROFILE RECESSED DEAD END CAP
plastic PC
□ 8974 ■ 8975

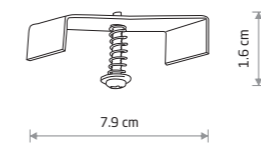

11 PROFILE RECESSED FIXING SET
steel
■ 8805



Bathroom lighting



ICE BALL 8126

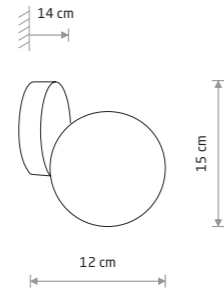

ICE BALL

brass-plated steel, glass

■ 8126

■ 1xG9, max 10W only LED

IP44

ARALIA

brass-plated steel, glass

■ 10527

■ 1xG9, max 10W only LED

IP44

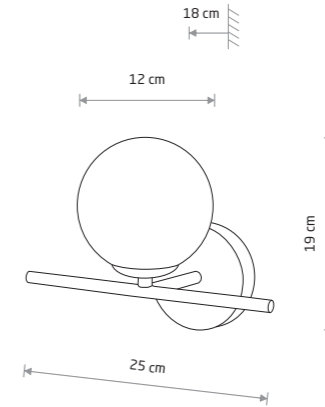

ARALIA 10527



ALOE 10525

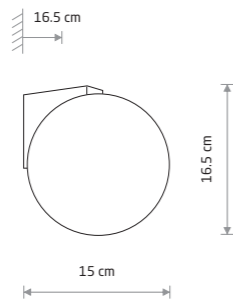

ALOE

brass-plated steel, glass

■ 10525

■ 1xG9, max 10W only LED

IP44

AGAVE

brass-plated steel, glass

■ 10526

■ 1xG9, max 10W only LED

IP44

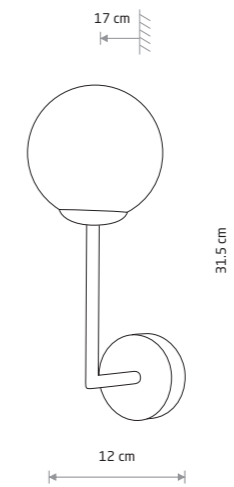

AGAVE 10526



NATALIE 10727



NATALIE 10727



NATALIE 10726



NATALIE 10724



NATALIE 10723

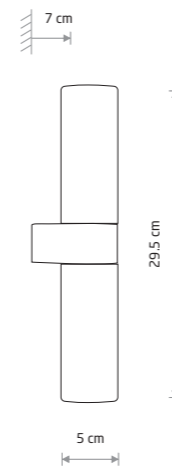

NATALIE
aluminum, glass

- 10726 10727 10728

2xG9, max 10W only LED

IP44

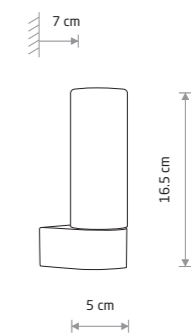

NATALIE
aluminum, glass

- 10723 10724 10725

1xG9, max 10W only LED

IP44



ICE TUBE LED S 8121

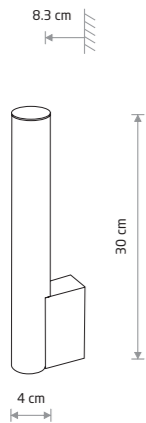

ICE TUBE LED S
plastic PC, chrome plated steel

8121



ICE TUBE LED M 8122

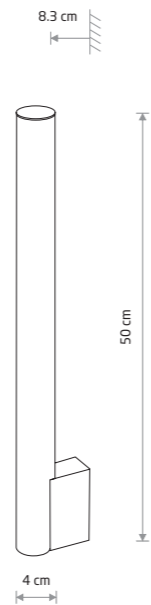

ICE TUBE LED M
plastic PC, chrome plated steel

8122



ICE TUBE LED S 8118

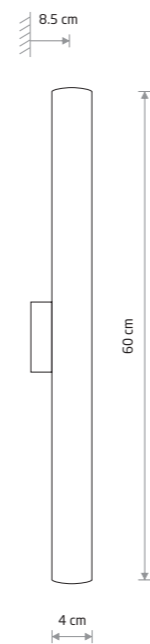

ICE TUBE LED S
plastic PC, chrome plated steel

8118



ICE TUBE LED M 8120

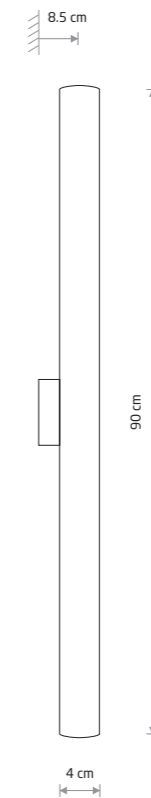

ICE TUBE LED M
plastic PC, chrome plated steel

8120



Item No.	Power	Colour temp.	Luminous flux	Beam angle	Colour Rendering Index (CRI)	Input	Safety type	Power factor	Ingress protection	Lifetime
8121	5W LED	4000K	430 lm	120°	≥80	~220-230 V, 50/60 Hz	☐	>0.5	IP44	30000h
8122	8W LED	4000K	700 lm	120°	≥80	~220-230 V, 50/60 Hz	☐	>0.5	IP44	30000h

Item No.	Power	Colour temp.	Luminous flux	Beam angle	Colour Rendering Index (CRI)	Input	Safety type	Power factor	Ingress protection	Lifetime
8118	12W LED	4000K	1200 lm	120°	≥80	~220-230 V, 50/60 Hz	☐	>0.5	IP44	30000h
8120	18W LED	4000K	1750 lm	120°	≥80	~220-230 V, 50/60 Hz	☐	>0.5	IP44	30000h

WHITE WHITE

WHITE CHROME



BRAZOS 6948

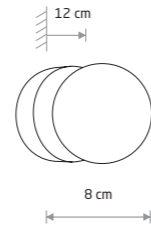

BRAZOS

glass, chrome plated steel

6948

1xG9, max 10W only LED

IP44



BRAZOS 6950

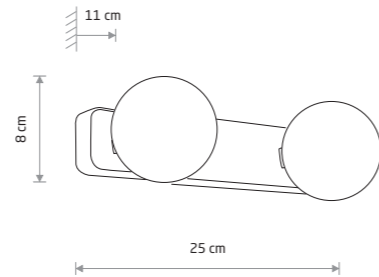

BRAZOS

glass, chrome plated steel

6950

2xG9, max 10W only LED

IP44



BRAZOS 6951

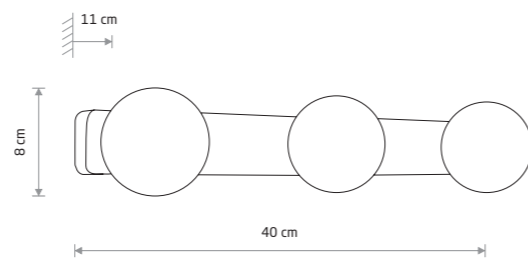

BRAZOS

glass, chrome plated steel

6951

3xG9, max 10W only LED

IP44

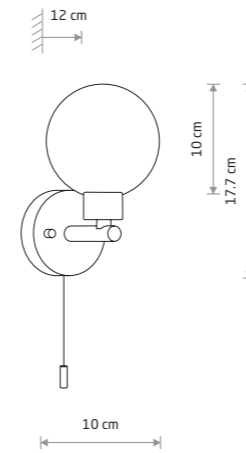

SIMI

painted steel, glass

8052

1xG9, max 10W only LED

IP44



SIMI 8052

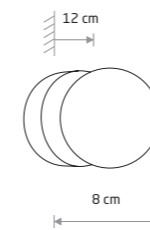

BRAZOS

painted steel, glass

8057

1xG9, max 10W only LED

IP44



BRAZOS 8057

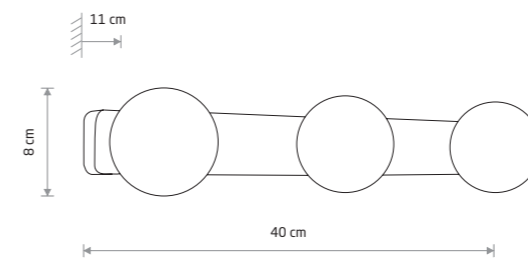

BRAZOS

glass, painted steel

8056

3xG9, max 10W only LED

IP44



BRAZOS 8056



ICE EGG A 8124

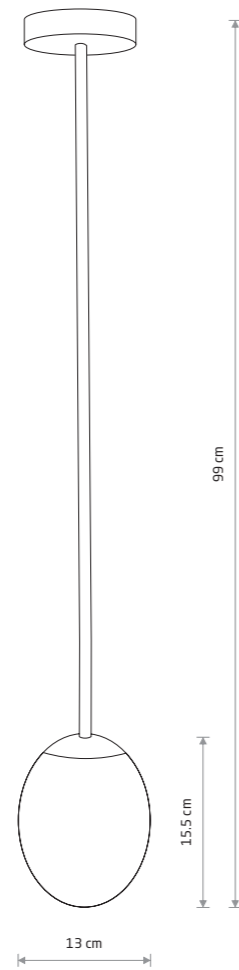

ICE EGG A
 painted steel, glass

■ 8124

- ☐ 1xG9, max 10W only LED
- IP44



ICE EGG C 8132

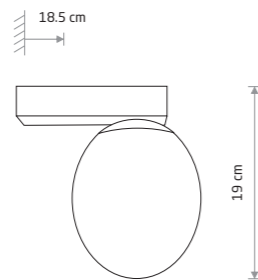

ICE EGG C
 painted aluminum, glass

■ 8132

- ☐ 1xG9, max 10W only LED
- IP44



SIS 8054

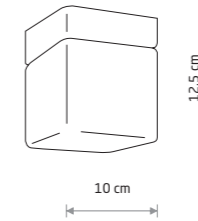

SIS
 glass, painted steel

■ 8054

- ☐ 1xG9, max 10W only LED
- IP44



CAYO 9505

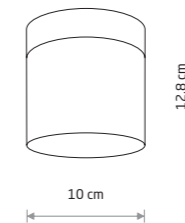

CAYO
 glass, painted steel

■ 8055

- ☐ 1xG9, max 10W only LED
- IP44

▨ 9505
 glass, chrome plated steel

▨ 9505

- ☐ 1xG9, max 10W only LED
- IP44



VISTA 8051

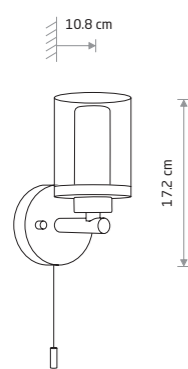

VISTA

chrome plated steel, glass

8051

1xG9, max 10W only LED

IP44



VISTA 8050

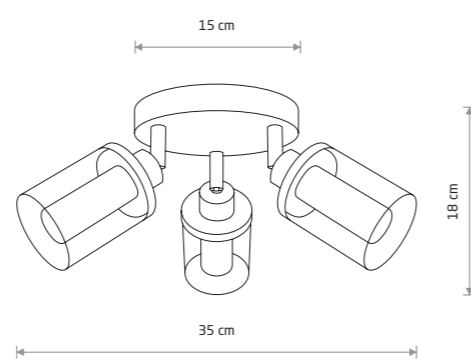

VISTA

chrome plated steel, glass

8050

3xG9, max 10W only LED

IP44



MALAKKA LED 9501

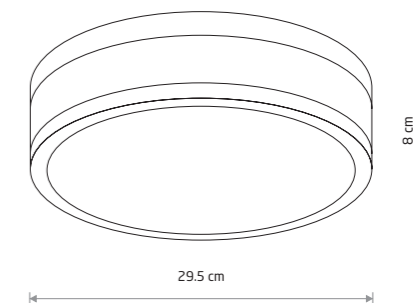

MALAKKA LED

chrome plated steel, glass

9501



PAN LED S 8173

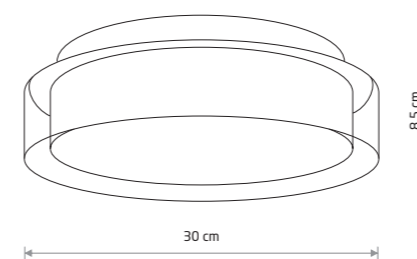

PAN LED S

glass, chrome plated steel

8173

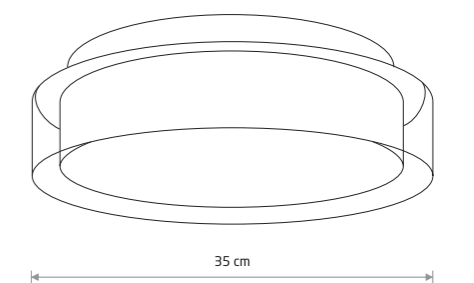

PAN LED M

glass, chrome plated steel

8174

Item No.	Power	Colour temp.	Luminous flux	Beam angle	Colour Rendering Index (CRI)	Input	Safety type	Power factor	Ingress protection	Lifetime
9501	18W LED	4000K	940 lm	120°	≥ 80	~220-230 V, 50/60 Hz	⊕	>0.5	IP44	20000h
8173	12W LED	4000K	770 lm	120°	≥80	~220-230 V, 50/60 Hz	⊕	>0.5	IP44	20000h
8174	17W LED	4000K	1000 lm	120°	≥80	~220-230 V, 50/60 Hz	⊕	>0.5	IP44	20000h



TORCH 8123

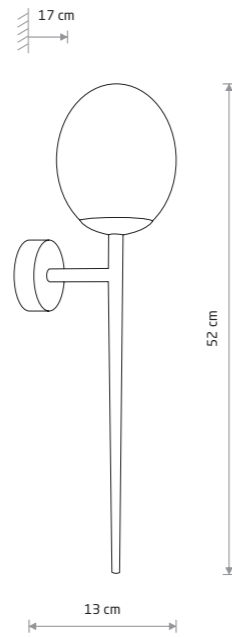

TORCH

chrome plated steel, glass

8123

1xG9, max 10W only LED

IP44

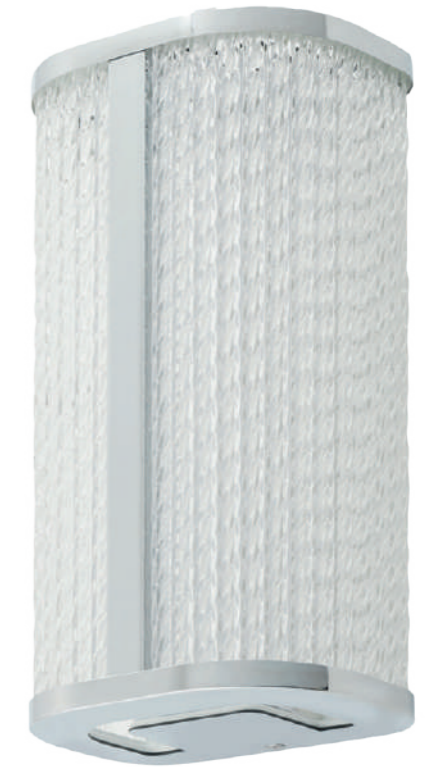

PALMAS LED 10729

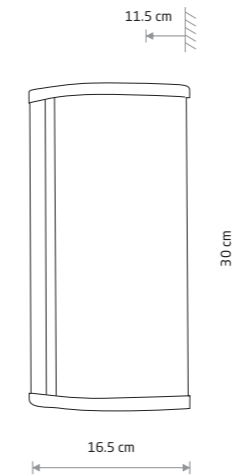

PALMAS LED

aluminum, glass, plastic PC

10729 10730



CEARA 10713

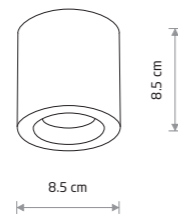

CEARA

aluminum

10713 10714

10715 10716

1xGU10 R50, max 15W only LED

IP44

Item No.	Power	Colour temp.	Luminous flux	Beam angle	Colour Rendering Index (CRI)	Input	Safety type	Power factor	Ingress protection	Lifetime
10729	15W LED	4000K	1000 lm	130°	>90	~220-230 V, 50/60 Hz	⊕	>0.9	IP44	30000h
10730	15W LED	4000K	1000 lm	130°	>90	~220-230 V, 50/60 Hz	⊕	>0.9	IP44	30000h



PARANA 10719



PARANA 10718

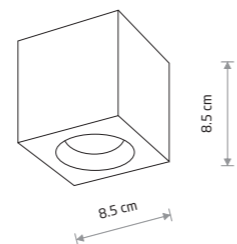

PARANA

aluminum

10717 10718

10719 10720

1xGU10 R50, max 15W only LED

IP44



BRAVO 8364



BRAVO 8365

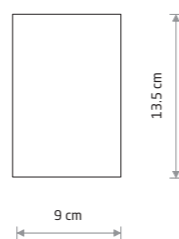

BRAVO

aluminum, glass

8364 8365

1xGU10 R50, max 15W only LED

IP54

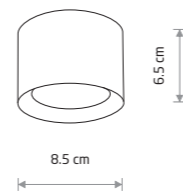

BOL

aluminum

10483 10484

1xGX53, max 12W only LED

IP54



BOL 10483

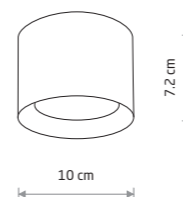

MAUN

aluminum

10481 10482

1xGX53, max 12W only LED

IP54



MAUN 10481

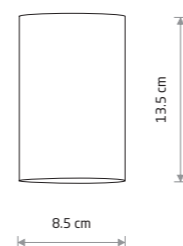

ALPHA

aluminum, glass

8362 8363

1xGU10 R50, max 15W only LED

IP54



ALPHA 8362

ZESTAW ZAWIERA 4 KOLOROWE NAKŁADKI.
THE SET INCLUDES FOUR COLOURED RINGS.



FOXTROT 8373



FOXTROT 8374

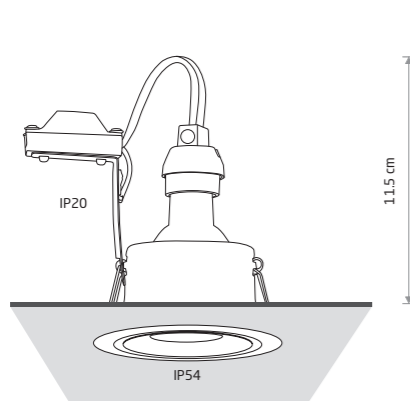
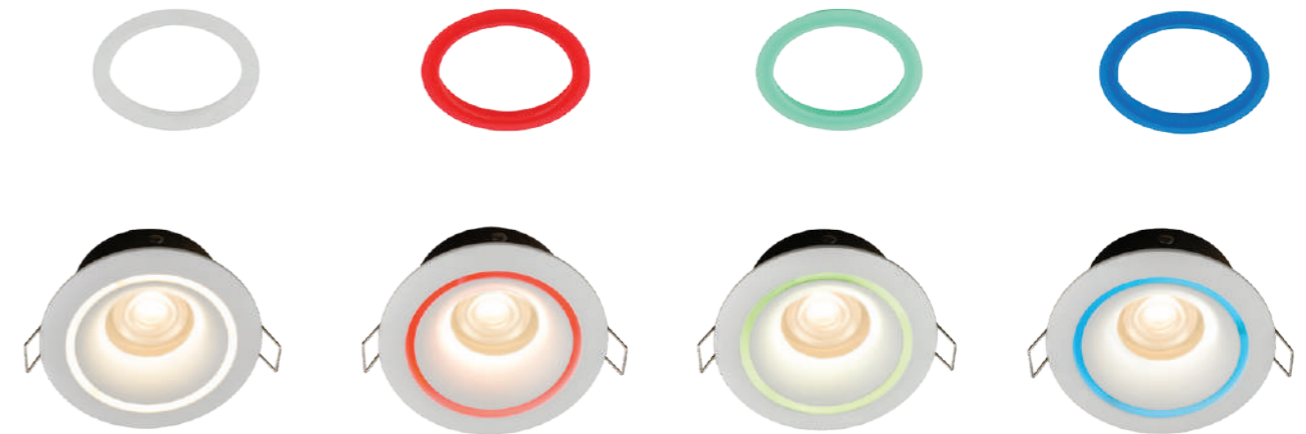

9.8 cm

FOXTROT

painting aluminum, glass

8373 8374

1xGU10 R50, max 15W only LED

cut out ø 85 mm

IP54/20

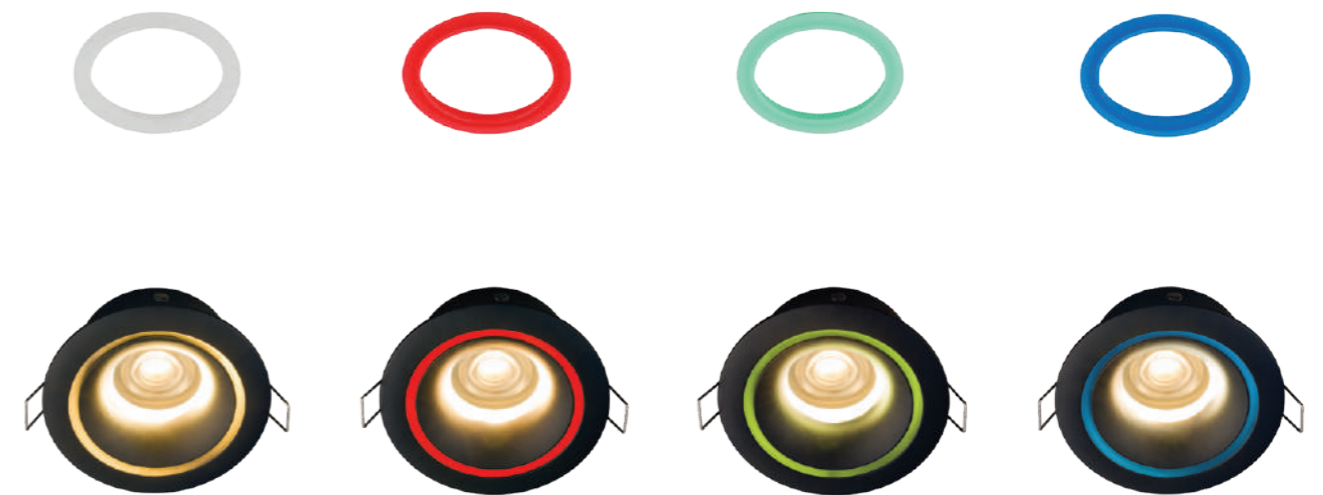



CHARLIE 8367

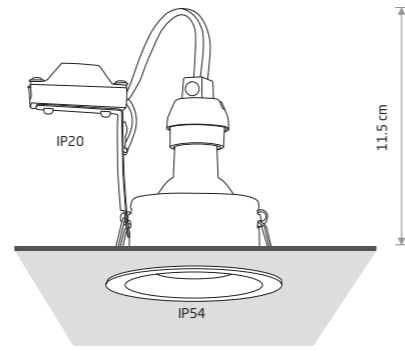
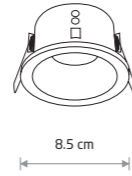

CHARLIE 8366

CHARLIE

■ painted aluminum, glass

□ 8366 ■ 8367

☛ 1xGU10 R50, max 15W only LED

🔪 cut out ø 75 mm

IP54/20



GOLF 8376

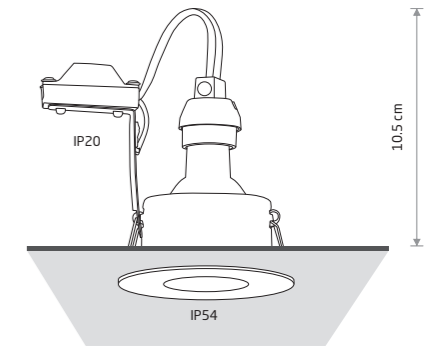

GOLF 8375

GOLF

■ painted aluminum, glass

□ 8375 ■ 8376

☛ 1xGU10 R50, max 15W only LED

🔪 cut out ø 68 mm

IP54/20



DELTA 8370

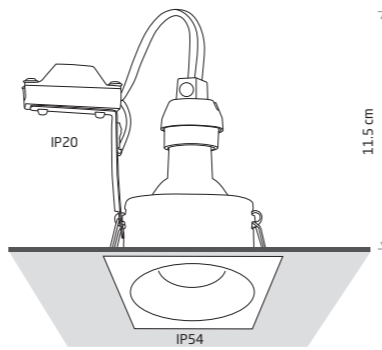
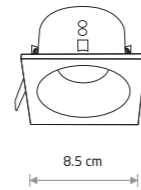

DELTA 8368

DELTA

■ painted aluminum, glass

□ 8368 ■ 8370

☛ 1xGU10 R50, max 15W only LED

🔪 cut out ø 75 mm

IP54/20



ECHO 8372

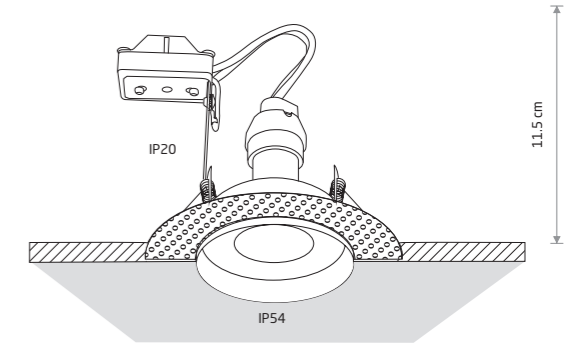
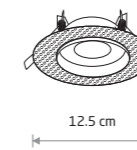

ECHO 8371

ECHO

■ painted aluminum, glass

□ 8371 ■ 8372

☛ 1xGU10 R50, max 15W only LED

🔪 cut out ø 80 mm

IP54/20



JULIET 7663

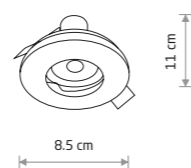

JULIET
steel

7663 7664

- 1xGU10 R50, max 15W only LED
- cut out ø 56 mm
- IP54/20



JULIET 7664

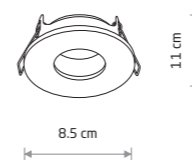

ACRE
aluminum, glass

10711

- 1xGU10 R50, max 15W only LED
- cut out ø 75 mm
- IP44/20



ACRE 10711



HELIOS LED 8992

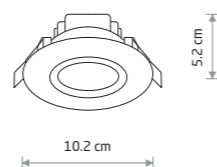

HELIOS LED
plastic PC

8991 3000K 8992 4000K

- cut out ø 85 mm

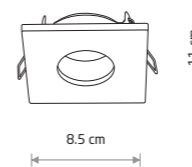

BAHIA
aluminum, glass

10712

- 1xGU10 R50, max 15W only LED
- cut out ø 75 mm
- IP44/20



BAHIA 10712

Item No.	Power	Colour temp.	Luminous flux	Beam angle	Colour Rendering Index (CRI)	Input	Safety type	Power factor	Ingress protection	Lifetime
8991	5W LED	3000K	300 lm	100°	≥ 80	~220-230 V, 50/60 Hz	☑	>0.5	IP44/20	20000h
8992	5W LED	4000K	300 lm	100°	≥ 80	~220-230 V, 50/60 Hz	☑	>0.5	IP44/20	20000h

WHITE CHROME SILVER

BRASS



PIN LED S 8127

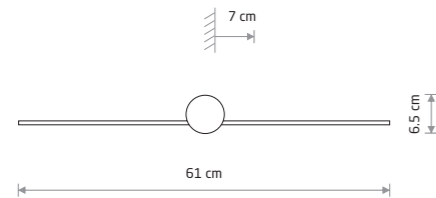

PIN LED S

■ painted aluminum, plastic PC

■ 8127

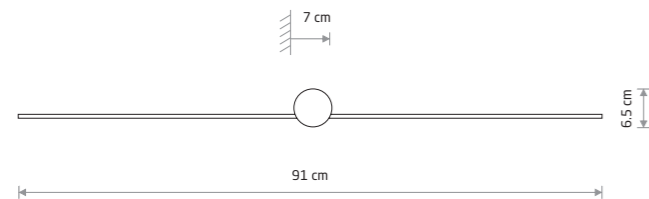

PIN LED M

■ painted aluminum, plastic PC

■ 8128

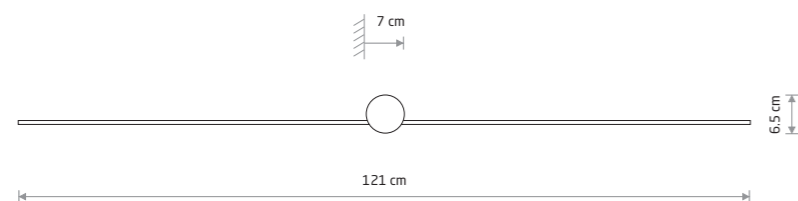

PIN LED L

■ painted aluminum, plastic PC

■ 8130



Item No.	Power	Colour temp.	Luminous flux	Beam angle	Colour Rendering Index (CRI)	Input	Safety type	Power factor	Ingress protection	Lifetime
8127	6W LED	4000K	280 lm	120°	≥80	~220-230 V, 50/60 Hz	☐	>0.9	IP44	30000h
8128	10W LED	4000K	500 lm	120°	≥80	~220-230 V, 50/60 Hz	☐	>0.9	IP44	30000h
8130	15W LED	4000K	700 lm	120°	≥80	~220-230 V, 50/60 Hz	☐	>0.9	IP44	30000h

■ BLACK



PICASSO LED 8131

PICASSO LED

■ chrome plated aluminum, plastic PC

■ 8131

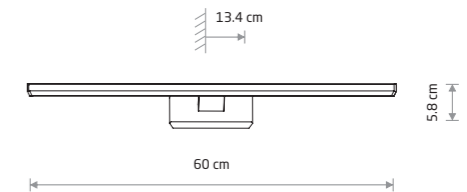

LATH LED 8175

LATH LED

■ chrome plated steel, plastic PC

■ 8175

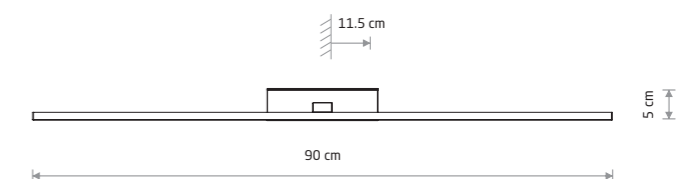

Item No.	Power	Colour temp.	Luminous flux	Beam angle	Colour Rendering Index (CRI)	Input	Safety type	Power factor	Ingress protection	Lifetime
8131	12W LED	4000K	900 lm	120°	≥80	~220-230 V, 50/60 Hz	☐	>0.5	IP44	30000h
8175	16W LED	4000K	1000 lm	120°	≥80	~220-230 V, 50/60 Hz	⊕	>0.5	IP44	20000h

■ CHROME

Sposoby montażu / Installation methods



1. Na lustrze
1. On the mirror

2. Na szafce łazienkowej
2. On the bathroom cabinet

3. Na ścianie
3. On the wall

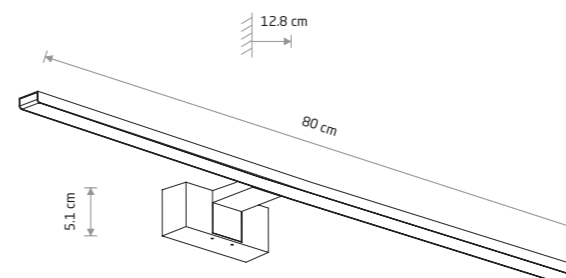
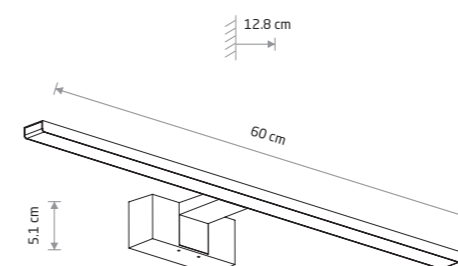
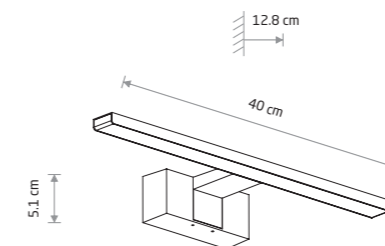

CEZANNE LED S

Painted aluminum, plastic ABS, plastic PMMA

- 10668 3000K ■ 10676 4000K
- ▨ 10665 3000K ▨ 10680 4000K
- 10672 3000K □ 10683 4000K

CEZANNE LED M

Painted aluminum, plastic ABS, plastic PMMA

- 10670 3000K ■ 10677 4000K
- ▨ 10666 3000K ▨ 10681 4000K
- 10673 3000K □ 10684 4000K

CEZANNE LED L

Painted aluminum, plastic ABS, plastic PMMA

- 10671 3000K ■ 10678 4000K
- ▨ 10667 3000K ▨ 10682 4000K
- 10674 3000K □ 10685 4000K

Item No.	Power	Colour temp.	Luminous flux	Beam angle	Colour Rendering Index (CRI)	Input	Safety type	Power factor	Ingress protection	Lifetime
10665	8W LED	3000K	600 lm	120°	≥ 80	~220-230 V, 50/60 Hz	□	>0.5	IP44	25000h
10668	8W LED	3000K	550 lm	120°	≥ 80	~220-230 V, 50/60 Hz	□	>0.5	IP44	25000h
10672	8W LED	3000K	600 lm	120°	≥ 80	~220-230 V, 50/60 Hz	□	>0.5	IP44	25000h
10676	8W LED	4000K	600 lm	120°	≥ 80	~220-230 V, 50/60 Hz	□	>0.5	IP44	25000h
10680	8W LED	4000K	650 lm	120°	≥ 80	~220-230 V, 50/60 Hz	□	>0.5	IP44	25000h
10683	8W LED	4000K	650 lm	120°	≥ 80	~220-230 V, 50/60 Hz	□	>0.5	IP44	25000h
10666	12W LED	3000K	900 lm	120°	≥ 80	~220-230 V, 50/60 Hz	□	>0.5	IP44	25000h
10670	12W LED	3000K	850 lm	120°	≥ 80	~220-230 V, 50/60 Hz	□	>0.5	IP44	25000h
10673	12W LED	3000K	900 lm	120°	≥ 80	~220-230 V, 50/60 Hz	□	>0.5	IP44	25000h
10681	12W LED	4000K	950 lm	120°	≥ 80	~220-230 V, 50/60 Hz	□	>0.5	IP44	25000h
10684	12W LED	4000K	950 lm	120°	≥ 80	~220-230 V, 50/60 Hz	□	>0.5	IP44	25000h
10677	12W LED	4000K	900 lm	120°	≥ 80	~220-230 V, 50/60 Hz	□	>0.5	IP44	25000h

Item No.	Power	Colour temp.	Luminous flux	Beam angle	Colour Rendering Index (CRI)	Input	Safety type	Power factor	Ingress protection	Lifetime
10667	15W LED	3000K	1100 lm	120°	≥ 80	~220-230 V, 50/60 Hz	□	>0.5	IP44	25000h
10671	15W LED	3000K	1050 lm	120°	≥ 80	~220-230 V, 50/60 Hz	□	>0.5	IP44	25000h
10674	15W LED	3000K	1100 lm	120°	≥ 80	~220-230 V, 50/60 Hz	□	>0.5	IP44	25000h
10678	15W LED	4000K	1100 lm	120°	≥ 80	~220-230 V, 50/60 Hz	□	>0.5	IP44	25000h
10682	15W LED	4000K	1200 lm	120°	≥ 80	~220-230 V, 50/60 Hz	□	>0.5	IP44	25000h
10685	15W LED	4000K	1200 lm	120°	≥ 80	~220-230 V, 50/60 Hz	□	>0.5	IP44	25000h

AGNES ROUND LED PRO
10980

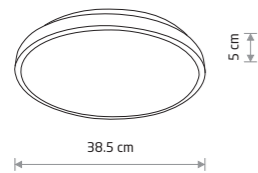

AGNES ROUND LED PRO

painted steel, plastic PMMA

- 10977 3000K 10978 4000K
- 10971 3000K 10972 4000K

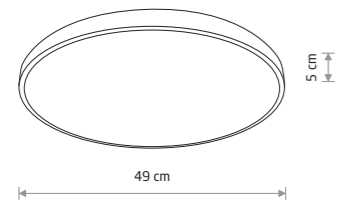

AGNES ROUND LED PRO

painted steel, plastic PMMA

- 10979 3000K 10980 4000K
- 10973 3000K 10974 4000K

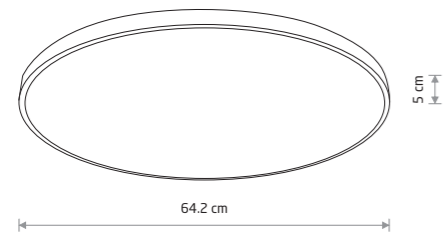

AGNES ROUND LED PRO

painted steel, plastic PMMA

- 10981 3000K 10982 4000K
- 10975 3000K 10976 4000K



AGNES SQUARE LED PRO
10987

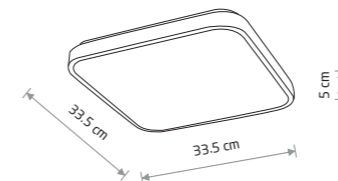

AGNES SQUARE LED PRO

painted steel, plastic PMMA

- 10989 3000K 10990 4000K
- 10983 3000K 10984 4000K

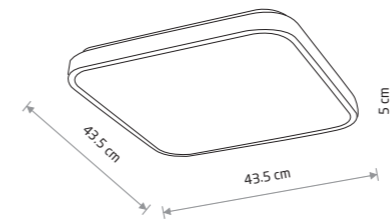

AGNES SQUARE LED PRO

painted steel, plastic PMMA

- 10991 3000K 10992 4000K
- 10985 3000K 10986 4000K

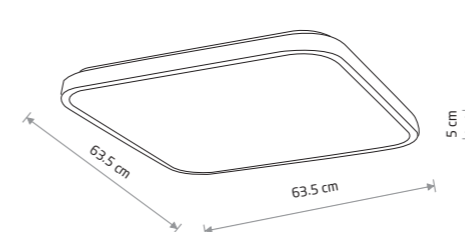

AGNES SQUARE LED PRO

painted steel, plastic PMMA

- 10993 3000K 10994 4000K
- 10987 3000K 10988 4000K



Item No.	Power	Colour temp.	Luminous flux	Beam angle	Colour Rendering Index (CRI)	Input	Safety type	Ingress protection	Lifetime
10971	22W LED	3000K	1600 lm	120°	>80	~220-230 V, 50-60 Hz	⊕	IP44	40000h
10972	22W LED	4000K	1800 lm	120°	>80	~220-230 V, 50/60 Hz	⊕	IP44	40000h
10973	32W LED	3000K	2600 lm	120°	>80	~220-230 V, 50-60 Hz	⊕	IP44	40000h
10974	32W LED	4000K	2700 lm	120°	>80	~220-230 V, 50-60 Hz	⊕	IP44	40000h
10975	64W LED	3000K	5600 lm	120°	>80	~220-230 V, 50/60 Hz	⊕	IP44	40000h
10976	64W LED	4000K	5900 lm	120°	>80	~220-230 V, 50-60 Hz	⊕	IP44	40000h
10977	22W LED	3000K	1800 lm	120°	>80	~220-230 V, 50-60 Hz	⊕	IP44	40000h
10978	22W LED	4000K	2000 lm	120°	>80	~220-230 V, 50-60 Hz	⊕	IP44	40000h
10979	32W LED	3000K	2800 lm	120°	>80	~220-230 V, 50/60 Hz	⊕	IP44	40000h
10980	32W LED	4000K	3000 lm	120°	>80	~220-230 V, 50/60 Hz	⊕	IP44	40000h
10981	64W LED	3000K	5800 lm	120°	>80	~220-230 V, 50/60 Hz	⊕	IP44	40000h
10982	64W LED	4000K	6200 lm	120°	>80	~220-230 V, 50/60 Hz	⊕	IP44	40000h

Item No.	Power	Colour temp.	Luminous flux	Beam angle	Colour Rendering Index (CRI)	Input	Safety type	Ingress protection	Lifetime
10983	16W LED	3000K	1200 lm	120°	>80	~220-230 V, 50/60 Hz	⊕	IP44	40000h
10984	16W LED	4000K	1300 lm	120°	>80	~220-230 V, 50/60 Hz	⊕	IP44	40000h
10985	32W LED	3000K	2700 lm	120°	>80	~220-230 V, 50/60 Hz	⊕	IP44	40000h
10986	32W LED	4000K	2800 lm	120°	>80	~220-230 V, 50/60 Hz	⊕	IP44	40000h
10987	64W LED	3000K	5600 lm	120°	>80	~220-230 V, 50/60 Hz	⊕	IP44	40000h
10988	64W LED	4000K	6000 lm	120°	>80	~220-230 V, 50/60 Hz	⊕	IP44	40000h
10989	16W LED	3000K	1400 lm	120°	>80	~220-230 V, 50/60 Hz	⊕	IP44	40000h
10990	16W LED	4000K	1500 lm	120°	>80	~220-230 V, 50/60 Hz	⊕	IP44	40000h
10991	32W LED	3000K	2900 lm	120°	>80	~220-230 V, 50/60 Hz	⊕	IP44	40000h
10992	32W LED	4000K	3100 lm	120°	>80	~220-230 V, 50/60 Hz	⊕	IP44	40000h
10993	64W LED	3000K	6100 lm	120°	>80	~220-230 V, 50/60 Hz	⊕	IP44	40000h
10994	64W LED	4000K	6500 lm	120°	>80	~220-230 V, 50/60 Hz	⊕	IP44	40000h

WHITE BLACK

WHITE BLACK



Outdoor lighting



STONE S 10579

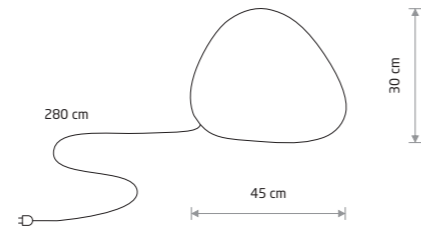

STONE S

plastic PE

10579

1xE27, max 25W only LED

IP44



STONE M 10580

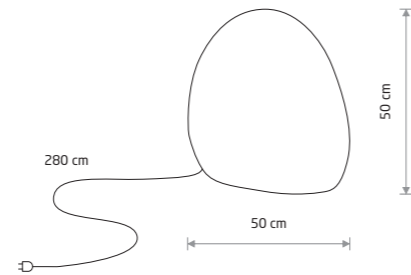

STONE M

plastic PE

10580

1xE27, max 25W only LED

IP44



STONE L 10581

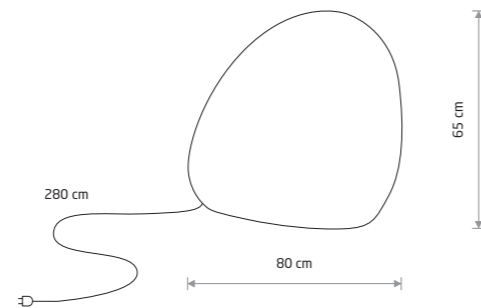

STONE L

plastic PE

10581

1xE27, max 25W only LED

IP44

WHITE



STONE S 10579

STONE L 10581

STONE M 10580

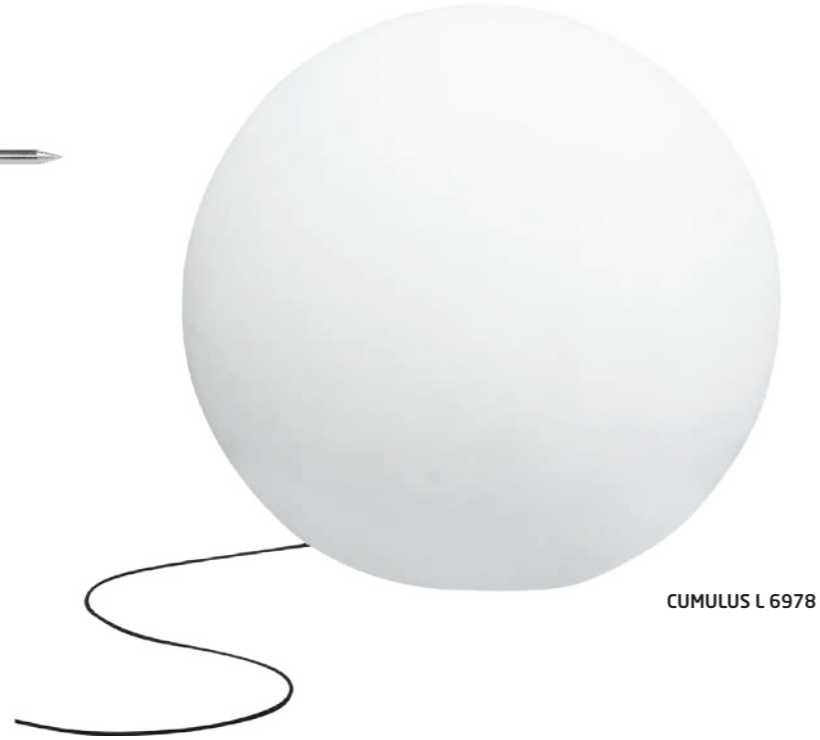

CUMULUS L 6978



CUMULUS S 9751



CUMULUS M 9715

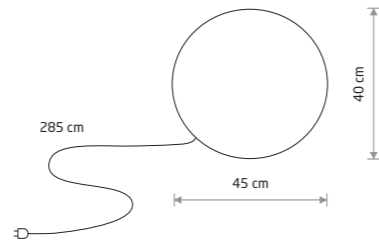
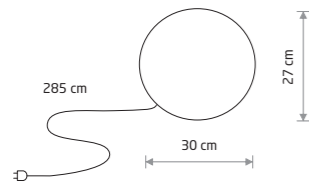

CUMULUS S

plastic PE

6976

1xE27, max 25W only LED

IP44

CUMULUS M

plastic PE

6977

1xE27, max 25W only LED

IP44

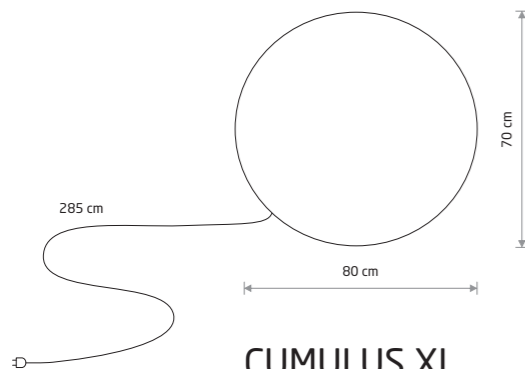

CUMULUS XL

plastic PE

9714

1xE27, max 25W only LED

IP44

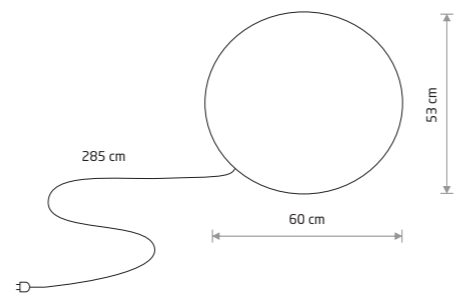

CUMULUS L

plastic PE

6978

1xE27, max 25W only LED

IP44

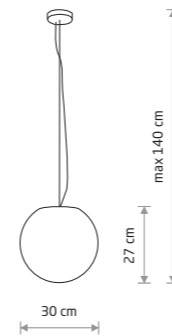

CUMULUS S

plastic PE, painted steel

9751

1xE27, max 25W only LED

IP65

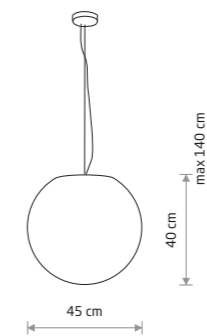

CUMULUS M

plastic PE, painted steel

9715

1xE27, max 25W only LED

IP65

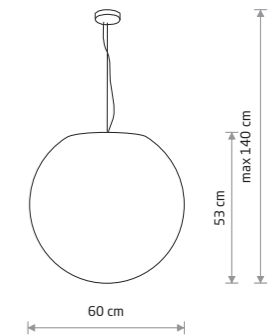

CUMULUS L

plastic PE, painted steel

9607

1xE27, max 25W only LED

IP65



FLOWERPOT S 9711

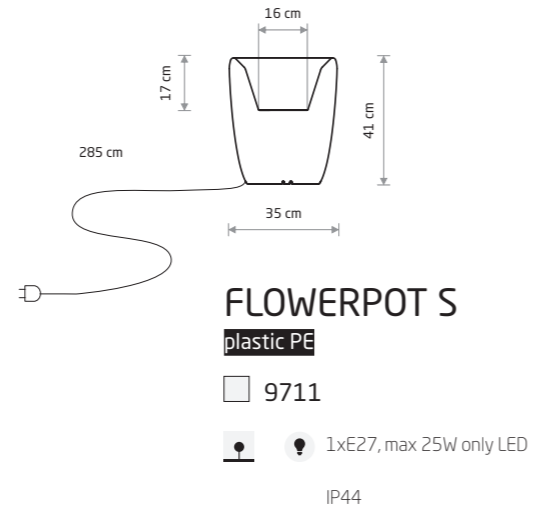

FLOWERPOT M 9712

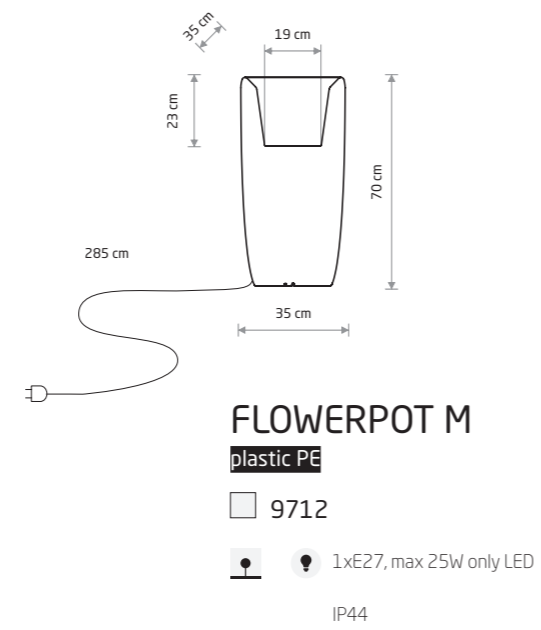

FLOWERPOT L 9713

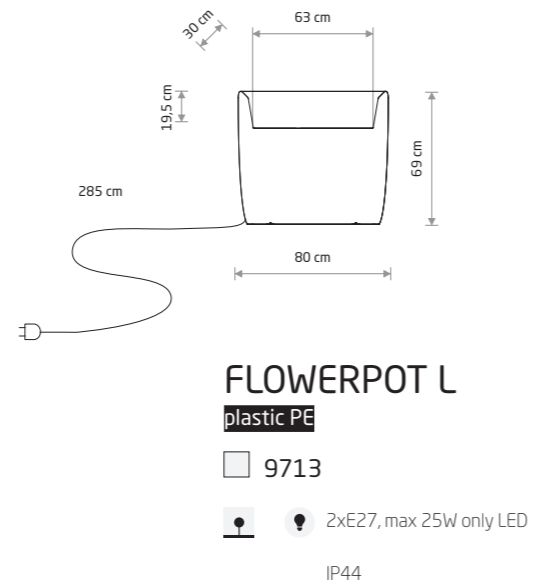

FLOWERPOT S 9711

FLOWERPOT M 9712

FLOWERPOT S 9711



CUMULUS CUBE M 8966

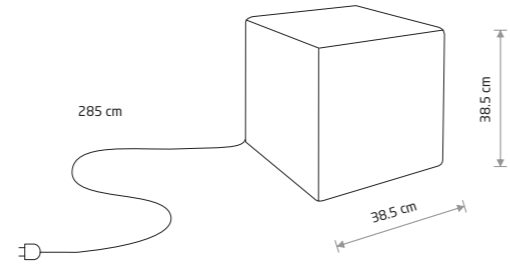

CUMULUS CUBE M

plastic PE

8966

1xE27, max 25W only LED

IP44

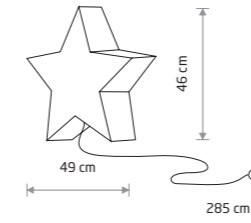

STAR

plastic PE

9426

1xE27, max 25W only LED

IP44



STAR 9426



CUMULUS CUBE L 8965

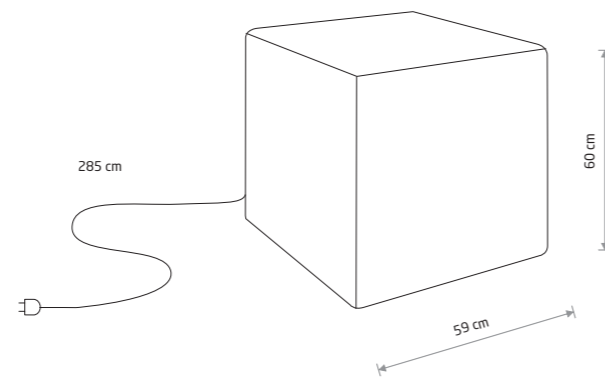

CUMULUS CUBE L

plastic PE

8965

1xE27, max 25W only LED

IP44

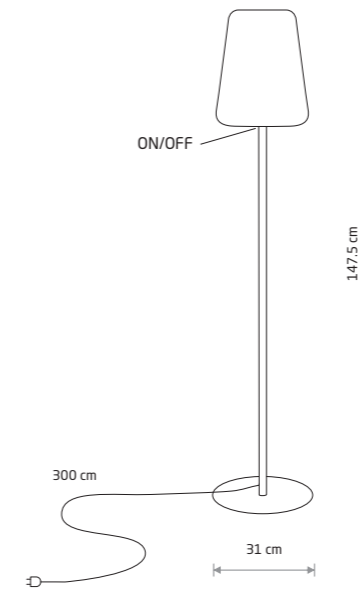

PATIO

painted steel, plastic LLDPE

10105

1xE27, max 25W only LED

IP44



PATIO 10105





ZOLA LED 11546

ZOLA LED 11545

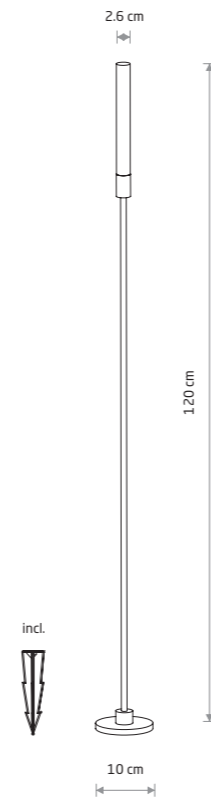

ZOLA LED
 painted aluminum, plastic PC
 ■ 11546
 ●

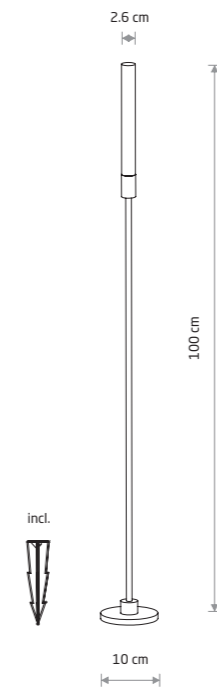

ZOLA LED
 painted aluminum, plastic PC
 ■ 11545
 ●

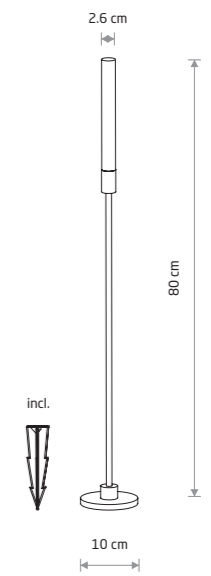

ZOLA LED
 painted aluminum, plastic PC
 ■ 11544
 ●

Item No.	Power	Colour temp.	Luminous flux	Beam angle	Colour Rendering Index (CRI)	VOLTAGE DC	Safety type	Ingress protection	Lifetime
11544	3W LED	3000K	100 lm	360°	>90	24V	⚡	IP54	30000h
11545	3W LED	3000K	100 lm	360°	>90	24V	⚡	IP54	30000h
11546	3W LED	3000K	100 lm	360°	>90	24V	⚡	IP54	30000h



RUBY LED 11542

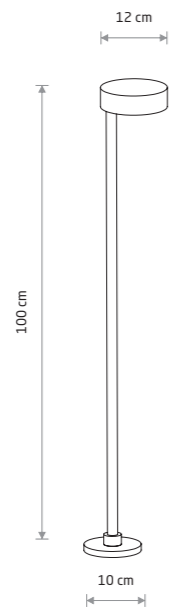

incl.



RUBY LED

painting aluminum, plastic PC

■ 11542



TESSA LED 11541

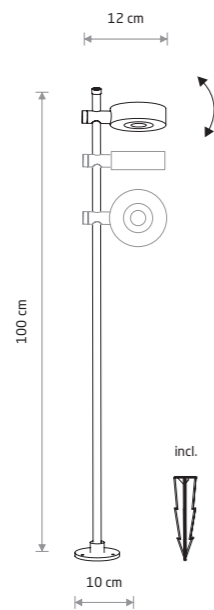

incl.



TESSA LED

painting aluminum, plastic PC

■ 11541



Item No.	Power	Colour temp.	Luminous flux	Beam angle	Colour Rendering Index (CRI)	Input	Safety type	Power factor	Ingress protection	Lifetime
11542	7W LED	3000K	400 lm	24 °	>90	~220-230 V, 50/60 Hz	⊕	>0.7	IP54	30000h
11541	7W LED	3000K	400 lm	70 °	>90	~220-230 V, 50/60 Hz	⊕	>0.7	IP54	30000h

■ BLACK



LIV LED 11538

Visualisation by Iwona Ligęza

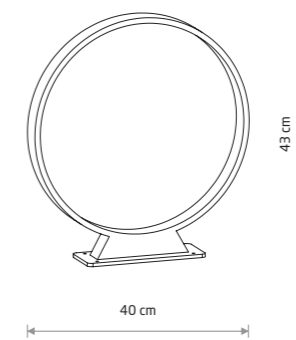

LIV LED

painting aluminum, plastic PC

■ 11538



Item No.	Power	Colour temp.	Luminous flux	Beam angle	Colour Rendering Index (CRI)	Input	Safety type	Power factor	Ingress protection	Lifetime
11538	6W LED	3000K	200 lm	20 °	>90	~220-230 V, 50/60 Hz	⊕	>0.7	IP54	30000h

■ BLACK



MIA LED M
11374

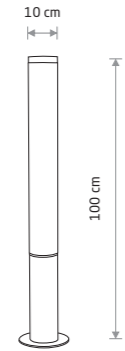

MIA LED M

■ painted aluminum, plastic PC

■ 11374



MIA LED L
11375

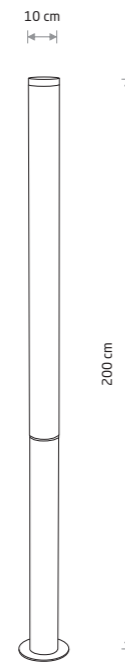

MIA LED L

■ painted aluminum, plastic PC

■ 11375



Item No.	Power	Colour temp.	Luminous flux	Beam angle	Colour Rendering Index (CRI)	Input	Safety type	Power factor	Ingress protection	Lifetime
11374	30W LED	3000K	2500 lm	70°	>80	~220-230 V, 50/60 Hz	⊕	>0.9	IP54	30000h
11375	100W LED	3000K	7800 lm	70°	>80	~220-230 V, 50/60 Hz	⊕	>0.9	IP54	30000h

IDA

■ painted aluminum, glass

■ 11371

■ 1xE27, max 10W LED

IP44

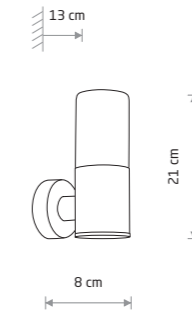

IDA
11371



IDA

■ painted aluminum, glass

■ 11372

■ 2xE27, max 10W LED

IP44

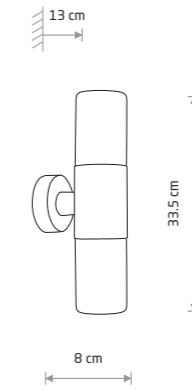

IDA
11372



IDA

■ painted aluminum, glass

■ 11373

■ 1xE27, max 10W LED

IP44

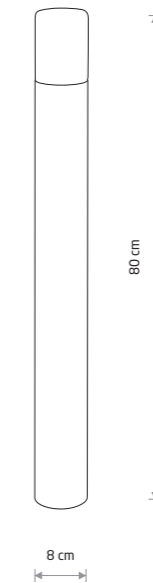

IDA
11373



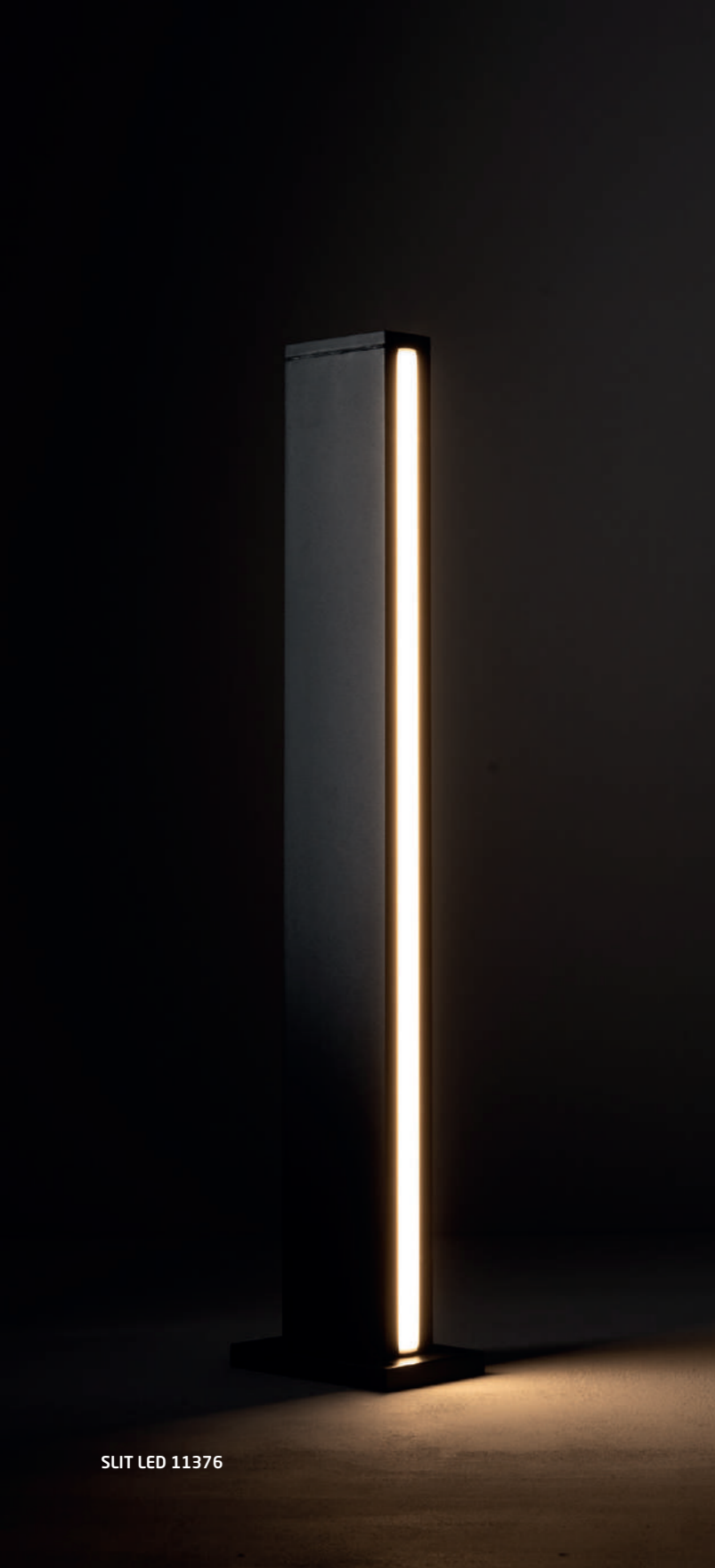

SLIT LED 11376

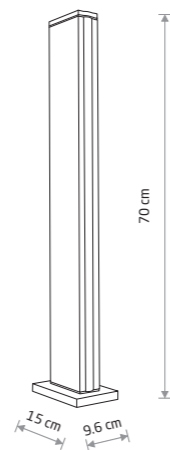

SLIT LED
 painted aluminum, plastic PC
 ■ 11376

SLIM LED
 painted aluminum, plastic PC
 ■ 11540

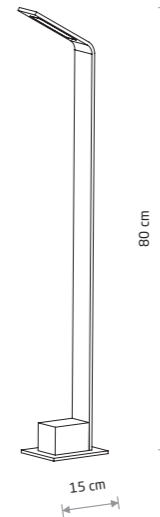

SLIM LED 11540



LHOTSE LED
 painted aluminum, plastic PC
 ■ 4448

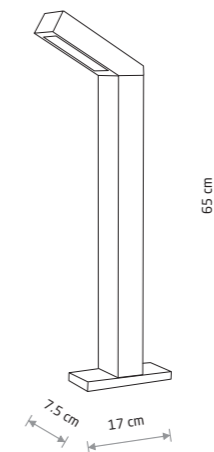

LHOTSE LED 4448

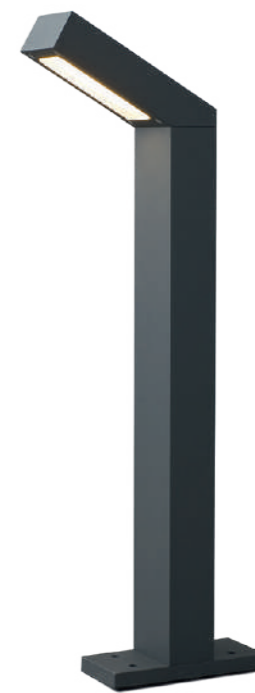

Item No.	Power	Colour temp.	Luminous flux	Beam angle	Colour Rendering Index (CRI)	Input	Safety type	Power factor	Ingress protection	Lifetime
11376	12W LED	3000K	600 lm	100°	>80	~220-230 V, 50/60 Hz	⊕	>0.5	IP54	30000h

Item No.	Power	Colour temp.	Luminous flux	Beam angle	Colour Rendering Index (CRI)	Input	Safety type	Power factor	Ingress protection	Lifetime
11540	7W LED	3000K	450 lm	120°	>90	~220-230 V, 50/60 Hz	⊕	>0.7	IP54	30000h
4448	9W LED	3000K	169 lm	70°	≥ 80	~220-230 V, 50/60 Hz	⊕	>0.8	IP54	10000h

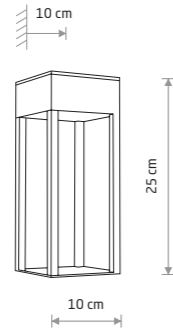

STRUCTURE LED

■ painted aluminum, plastic PC

■ 8146



STRUCTURE LED 8146

SYMMETRY LED

■ painted aluminum, plastic PC

■ 8176

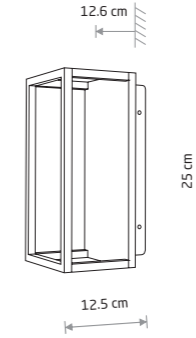

SYMMETRY LED 8176

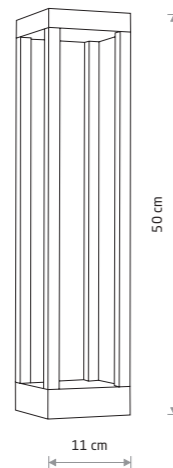

STRUCTURE LED

■ painted aluminum, plastic PC

■ 8145



STRUCTURE LED 8145

SYMMETRY LED

■ painted aluminum, plastic PC

■ 8180

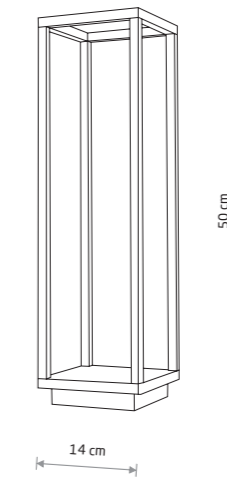

SYMMETRY LED 8180

Item No.	Power	Colour temp.	Luminous flux	Beam angle	Colour Rendering Index (CRI)	Input	Safety type	Power factor	Ingress protection	Lifetime
8145	13W LED	3000K	820 lm	120°	≥80	~220-230 V, 50/60 Hz	⊕	>0.9	IP54	20000h
8146	13W LED	3000K	820 lm	120°	≥80	~220-230 V, 50/60 Hz	⊕	>0.9	IP54	20000h

Item No.	Power	Colour temp.	Luminous flux	Beam angle	Colour Rendering Index (CRI)	Input	Safety type	Power factor	Ingress protection	Lifetime
8176	7W LED	3000K	210 lm	70°	>80	~220-230 V, 50/60 Hz	⊕	>0.9	IP54	30000h
8180	7W LED	3000K	380 lm	70°	>80	~220-230 V, 50/60 Hz	⊕	>0.9	IP54	30000h

TEPIC LED 9508

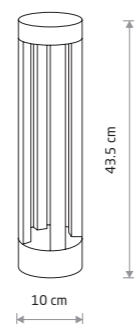

TEPIC LED

■ painted aluminum

■ 9508



THIKA LED B

■ painted aluminum, glass

■ 9120

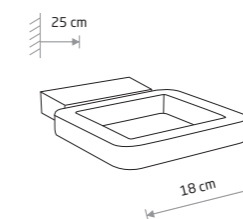

THIKA LED B 9120



MONTERREY LED 9507

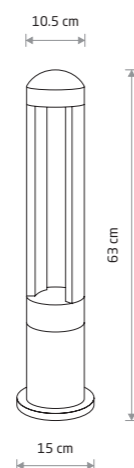

MONTERREY LED

■ painted aluminum

■ 9507



THIKA LED

■ painted aluminum, glass

■ 9118

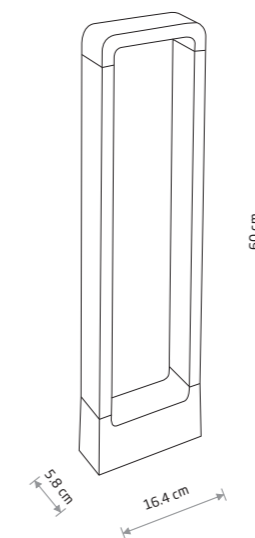

THIKA LED 9118



Item No.	Power	Colour temp.	Luminous flux	Beam angle	Colour Rendering Index (CRI)	Input	Safety type	Power factor	Ingress protection	Lifetime
9508	9W LED	3000K	395 lm	30 °	≥ 80	~220-230 V, 50/60 Hz	⊕	>0.8	IP54	10000h
9507	9W LED	3000K	410 lm	40 °	≥ 80	~220-230 V, 50/60 Hz	⊕	>0.8	IP54	10000h

Item No.	Power	Colour temp.	Luminous flux	Beam angle	Colour Rendering Index (CRI)	Input	Safety type	Power factor	Ingress protection	Lifetime
9118	9W LED	3000K	550 lm	40 °	≥ 80	~220-230 V, 50/60 Hz	⊕	>0.5	IP54	20000h
9120	15W LED	3000K	1200 lm	110 °	≥ 80	~220-230 V, 50/60 Hz	⊕	>0.9	IP54	20000h



POLE LED 9185

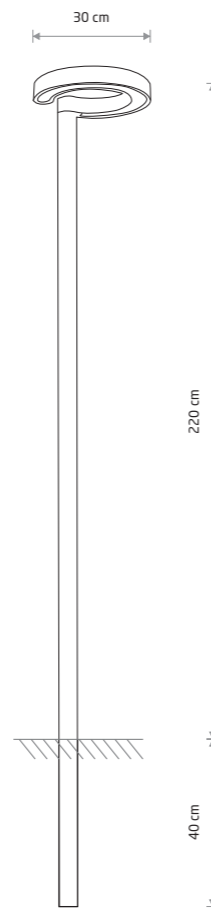

POLE LED

painting aluminum, plastic PC

■ 9185

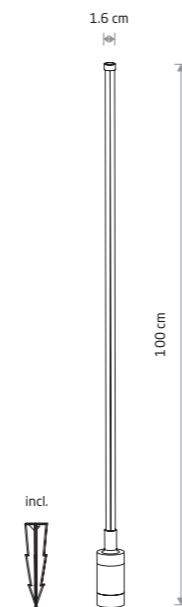

ZURI LED

painting aluminum, plastic PC

■ 11547



ZURI LED 11547

Item No.	Power	Colour temp.	Luminous flux	Beam angle	Colour Rendering Index (CRI)	Input	Safety type	Power factor	Ingress protection	Lifetime
9185	15W LED	3000K	1000 lm	70°	>80	~220-230 V, 50/60 Hz	⊕	>0.9	IP54	30000h

Item No.	Power	Colour temp.	Luminous flux	Beam angle	Colour Rendering Index (CRI)	Input	Safety type	Power factor	Ingress protection	Lifetime
11547	12W LED	3000K	850 lm	120°	>90	~220-230 V, 50/60 Hz	⊕	>0.7	IP54	30000h

■ GRAPHITE

■ BLACK



OTTAWA 9562

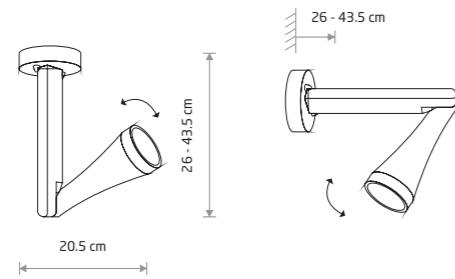

OTTAWA

■ painted aluminum, glass

■ 9562

● 1xGU10 R50, max 10W only LED

IP44

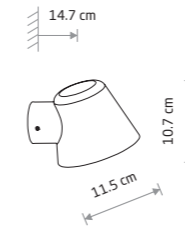

SOUL

■ painted aluminum, glass

■ 9555

● 1xGU10 R50, max 10W only LED

IP44



SOUL 9555



OTTAWA 9561

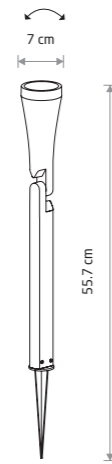

OTTAWA

■ painted aluminum, glass

■ 9561

● 1xGU10 R50, max 10W only LED

IP44

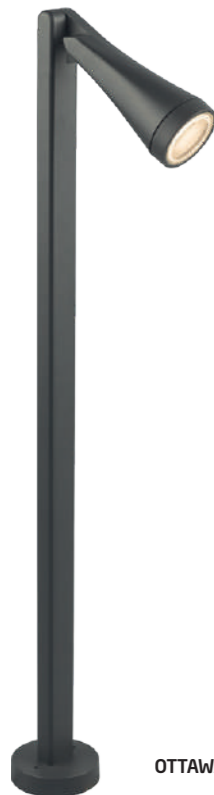

OTTAWA 9563



OTTAWA

■ painted aluminum, glass

■ 9563

● 1xGU10 R50, max 10W only LED

IP44

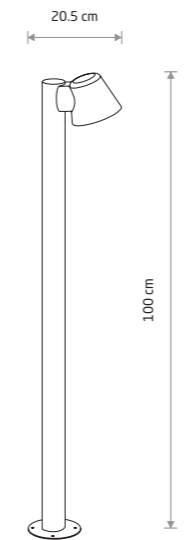

SOUL

■ painted aluminum, glass

■ 9557

● 1xGU10 R50, max 10W only LED

IP44



SOUL 9557



NORIN 4446

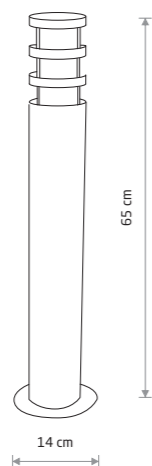

NORIN

■ painted aluminum, glass

■ 4446

● 1xE27, max 10W only LED

IP44



HORN 4906

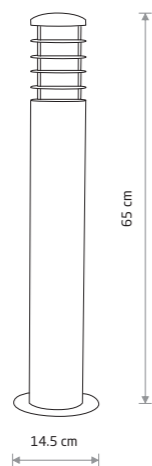

HORN

■ painted aluminum, glass

■ 4906

● 1xE27, max 10W only LED

IP44

TUBINGS S 8160

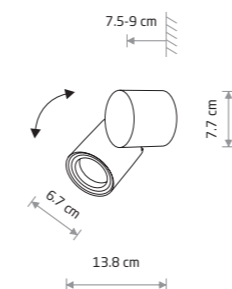

TUBINGS S

■ painted aluminum, glass

■ 8160

● 1xGU10 R50, max 10W only LED

IP54

TUBINGS M 8161

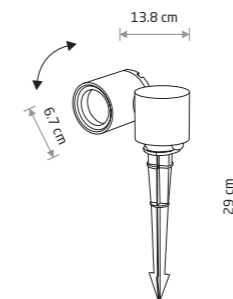

TUBINGS M

■ painted aluminum, glass, plastic

■ 8161

● 1xGU10 R50, max 10W only LED

IP54

TUBINGS 8158

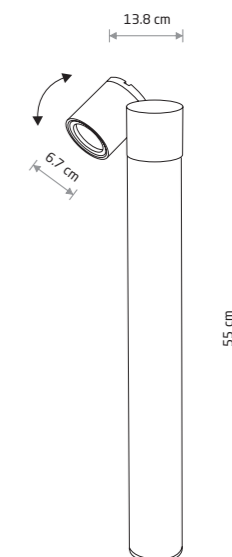

TUBINGS

■ painted aluminum, glass

■ 8158

● 1xGU10 R50, max 10W only LED

IP54

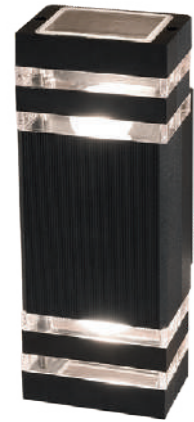

RIO 4424

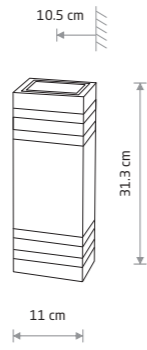

RIO

■ painted aluminum, plastic PC

■ 4424

● 2xE27, max 10W only LED

IP54

OIR

■ painted aluminum, plastic PC

■ 9158

● 1xE27, max 10W only LED

IP44

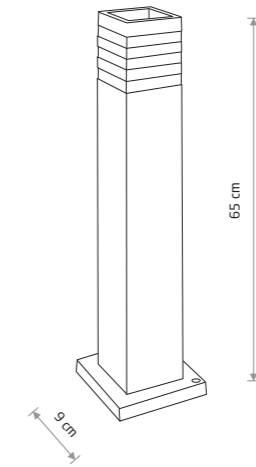

OIR 9158

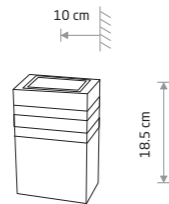

RIO

■ painted aluminum, plastic PC

■ 4423

● 1xE27, max 10W only LED

IP54



RIO SENSOR 7017

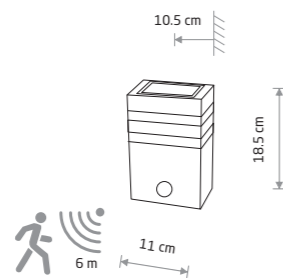

RIO SENSOR

■ painted aluminum, plastic PC

■ 7017

● 1xE27, max 10W only LED

IP54

RIO SENSOR

■ painted aluminum, plastic PC

■ 9097

● 1xE27, max 10W only LED

IP54

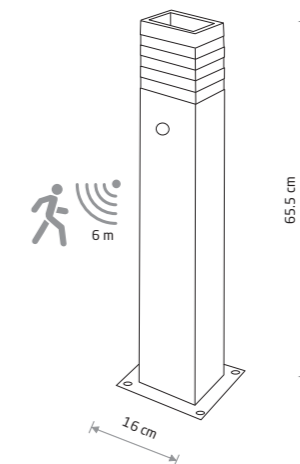

RIO SENSOR 9097





MEKONG 4418

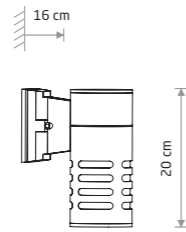

MEKONG

■ painted aluminum, glass

■ 4418

● 1xE27, max 10W only LED

IP42



MEKONG 4420

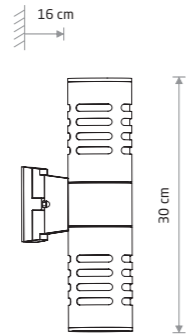

MEKONG

■ painted aluminum, glass

■ 4420

● 2xE27, max 10W only LED

IP42



MEKONG 4698



MEKONG

■ painted aluminum, glass

■ 4698

● 1xE27, max 10W only LED

IP42

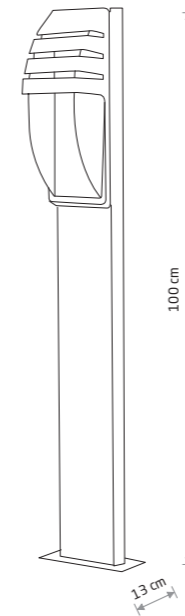

MISTRAL

■ painted aluminum, plastic PC

■ 3394

● 1xE27, max 10W only LED

IP44



MISTRAL 3394



PATHWAY LED PRO 10283

PATHWAY LED PRO

■ painted steel, painted aluminum, plastic

■ 10283 3000K ■ 10633 4000K

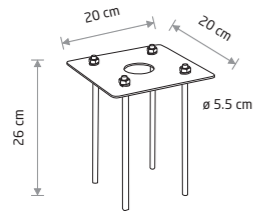

PATHWAY FOUNDATION KIT

■ steel

■ 8795

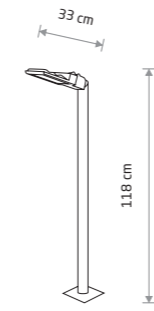
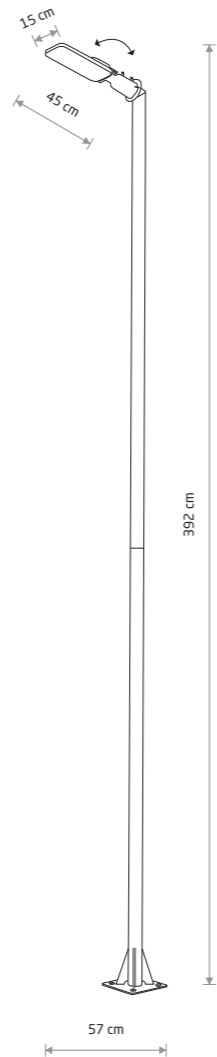

PATHWAY LED S

■ painted steel, painted aluminum, plastic

■ 9420

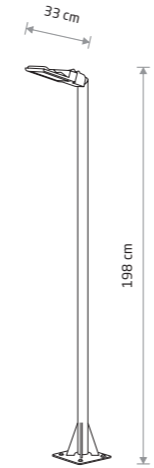

PATHWAY LED M

■ painted steel, painted aluminum, plastic

■ 9252

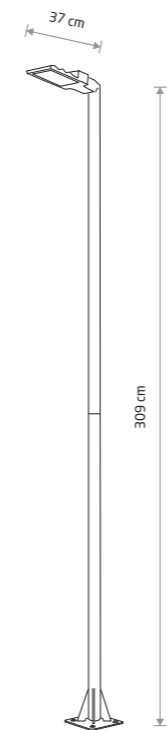

PATHWAY LED L

■ painted steel, painted aluminum, plastic

■ 9125



PATHWAY LED S 9420

PATHWAY LED M 9252

Item No.	Power	Colour temp.	Luminous flux	Beam angle	Colour Rendering Index (CRI)	Input	Safety type	Power factor	Ingress protection	Lifetime
10283	60W LED	3000K	5700 lm	100°	>80	~220-230 V, 50/60 Hz	⊕	>0.9	IP65	30000h
10633	60W LED	4000K	5900 lm	100°	>80	~220-230 V, 50/60 Hz	⊕	>0.9	IP65	30000h

Item No.	Power	Colour temp.	Luminous flux	Beam angle	Colour Rendering Index (CRI)	Input	Safety type	Power factor	Ingress protect	Lifetime
9420	24W LED	3000K	2200 lm	100°	≥ 70	~220-230 V, 50/60 Hz	⊕	>0.9	IP65	30000h
9252	24W LED	3000K	2200 lm	100°	≥ 70	~220-230 V, 50/60 Hz	⊕	>0.9	IP65	30000h
9125	36W LED	3000K	3600 lm	100°	≥ 70	~220-230 V, 50/60 Hz	⊕	>0.9	IP65	30000h

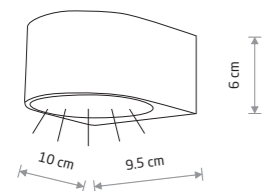
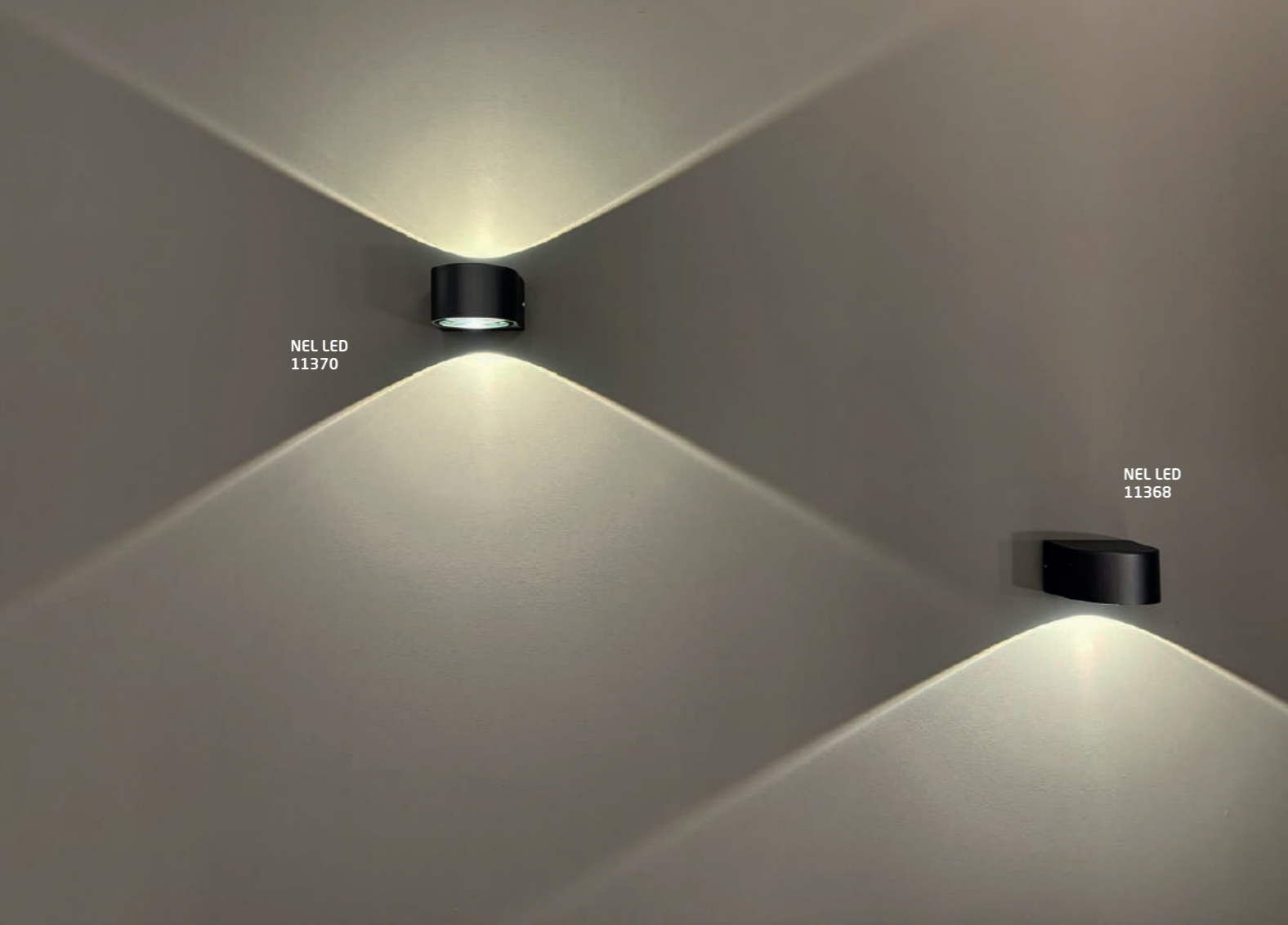

NEL LED
painted aluminum, glass

■ 11368

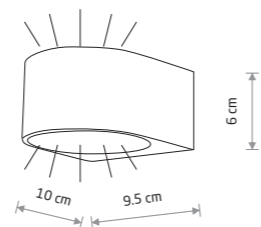

NEL LED
painted aluminum, glass

■ 11370



Item No.	Power	Colour temp.	Luminous flux	Beam angle	Colour Rendering Index (CRI)	Input	Safety type	Power factor	Ingress protection	Lifetime
11368	5W LED	3000K	500 lm	120°	>80	~220-230 V, 50/60 Hz	⊕	>0.5	IP54	30000h
11370	2x5W LED	3000K	880 lm	120°	>80	~220-230 V, 50/60 Hz	⊕	>0.5	IP54	30000h

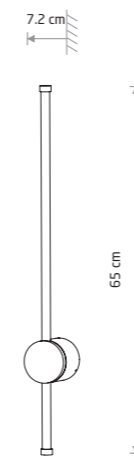

ORLA LED S
painted aluminum, plastic PC

■ 11548 ■ 11551

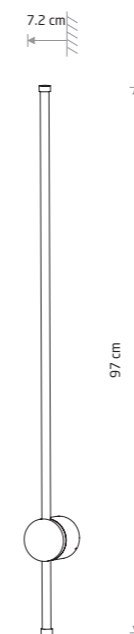

ORLA LED M
painted aluminum, plastic PC

■ 11550 ■ 11552



ORLA LED M 11552

Item No.	Power	Colour temp.	Luminous flux	Beam angle	Colour Rendering Index (CRI)	Input	Safety type	Power factor	Ingress protection	Lifetime
11548	12W LED	3000K	750 lm	120°	>90	~220-230V V, 50/60 Hz	⊕	>0.7	IP54	30000h
11550	20W LED	3000K	1300 lm	120°	>90	~220-230 V, 50/60 Hz	⊕	>0.7	IP54	30000h
11551	12W LED	3000K	750 lm	120°	>90	~220-230 V, 50/60 Hz	⊕	>0.7	IP54	30000h
11552	20W LED	3000K	1300 lm	120°	>90	~220-230 V, 50/60 Hz	⊕	>0.7	IP54	30000h

■ BLACK

Can be used in the bathroom

■ BLACK ■ SAND

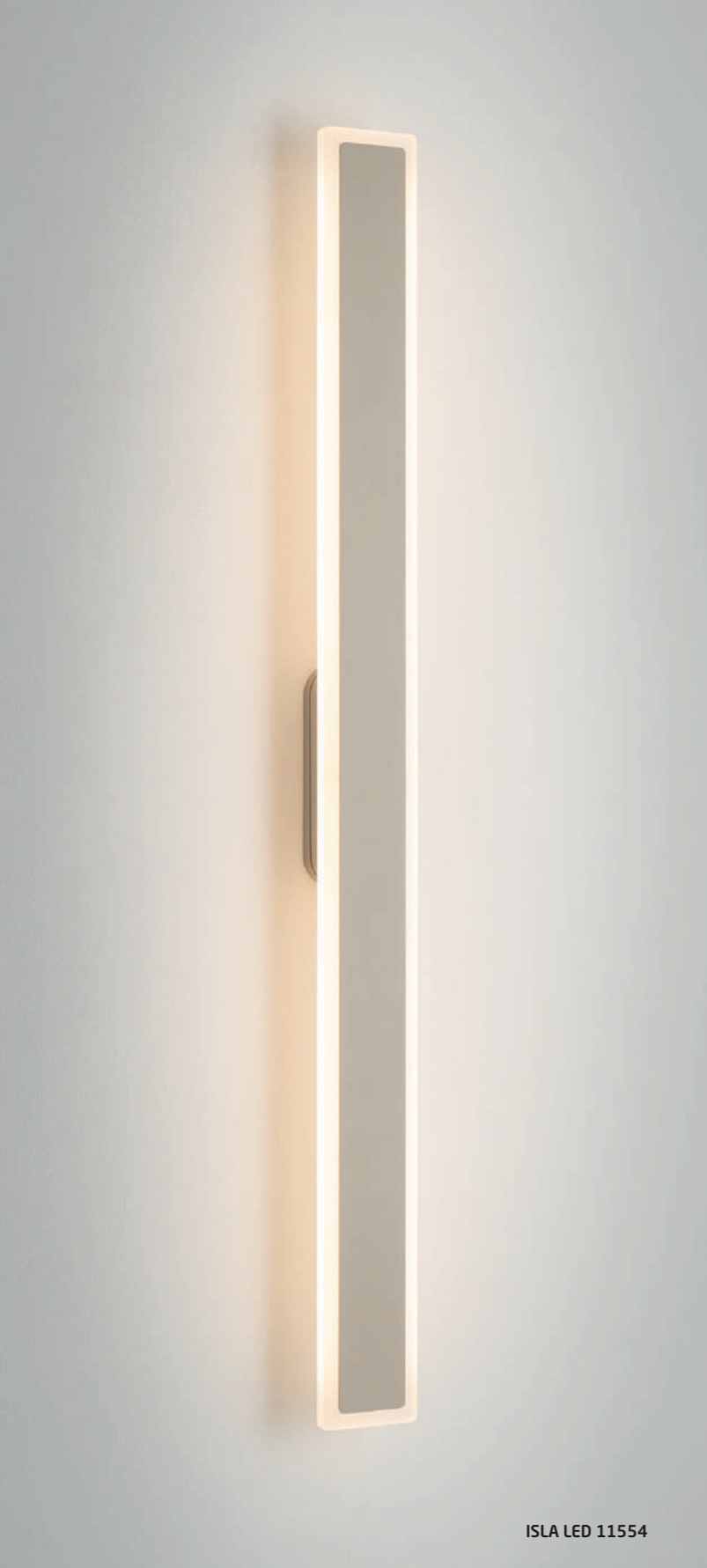

ISLA LED 11554

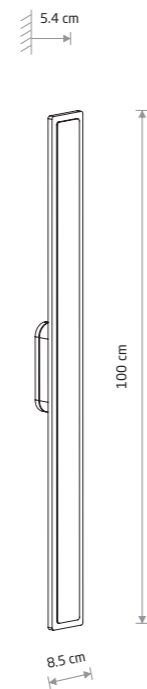

ISLA LED

Painted aluminum, plastic PMMA

■ 11553 ■ 11554



Item No.	Power	Colour temp.	Luminous flux	Beam angle	Colour Rendering Index (CRI)	Input	Safety type	Power factor	Ingress protection	Lifetime
11553	22W LED	3000K	1200 lm	>90°	120	~220-230 V, 50/60 Hz	⊕	>0.7	IP54	30000h
11554	22W LED	3000K	1200 lm	>90°	120	~220-230 V, 50/60 Hz	⊕	>0.7	IP54	30000h

■ BLACK ■ SAND

Can be used in the bathroom

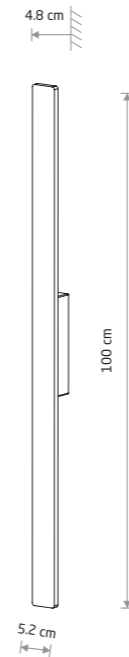

DEMI LED M

Painted aluminum, plastic PC

■ 11555 ■ 11556 ■ 11557

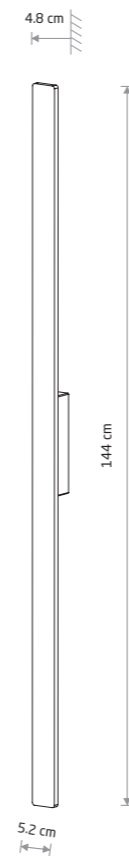

DEMI LED L

Painted aluminum, plastic PC

■ 11558 ■ 11560 ■ 11561



Item No.	Power	Colour temp.	Luminous flux	Beam angle	Colour Rendering Index (CRI)	Input	Safety type	Power factor	Ingress protection	Lifetime
11555	18W LED	3000K	1200 lm	110°	>90	~220-230 V, 50/60 Hz	⊕	>0.7	IP54	30000h
11556	18W LED	3000K	1200 lm	110°	>90	~220-230 V, 50/60 Hz	⊕	>0.7	IP54	30000h
11557	18W LED	3000K	1200 lm	110°	>90	~220-230 V, 50/60 Hz	⊕	>0.7	IP54	30000h
11558	24W LED	3000K	1500 lm	110°	>90	~220-230 V, 50/60 Hz	⊕	>0.7	IP54	30000h
11560	24W LED	3000K	1500 lm	110°	>90	~220-230 V, 50/60 Hz	⊕	>0.7	IP54	30000h
11561	24W LED	3000K	1500 lm	110°	>90	~220-230 V, 50/60 Hz	⊕	>0.7	IP54	30000h

DEMI LED L 11560

■ BLACK ■ SAND ■ BRICK RED

Can be used in the bathroom



ARIA LED S 11564



ARIA LED S

Painted aluminum, plastic PC

■ 11562 ■ 11563 ■ 11564



ARIA LED M 11566



ARIA LED M

Painted aluminum, plastic PC

■ 11565 ■ 11566 ■ 11567



ARIA LED L

Painted aluminum, plastic PC

■ 11568 ■ 11570 ■ 11571

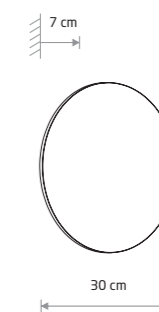

ARIA LED XL

Painted aluminum, plastic PC

■ 11572 ■ 11573 ■ 11574



Item No.	Power	Colour temp.	Luminous flux	Beam angle	Colour Rendering Index (CRI)	Input	Safety type	Power factor	Ingress protection	Lifetime
11562	6W LED	3000K	370 lm	110°	>90	~220-230 V, 50/60 Hz	⊕	>0.7	IP54	30000h
11563	6W LED	3000K	370 lm	110°	>90	~220-230 V, 50/60 Hz	⊕	>0.7	IP54	30000h
11564	6W LED	3000K	370 lm	110°	>90	~220-230 V, 50/60 Hz	⊕	>0.7	IP54	30000h
11565	9W LED	3000K	540 lm	110°	>90	~220-230 V, 50/60 Hz	⊕	>0.7	IP54	30000h
11566	9W LED	3000K	540 lm	110°	>90	~220-230 V, 50/60 Hz	⊕	>0.7	IP54	30000h
11567	9W LED	3000K	540 lm	110°	>90	~220-230 V, 50/60 Hz	⊕	>0.7	IP54	30000h
11568	12W LED	3000K	750 lm	110°	>90	~220-230 V, 50/60 Hz	⊕	>0.7	IP54	30000h
11570	12W LED	3000K	750 lm	110°	>90	~220-230 V, 50/60 Hz	⊕	>0.7	IP54	30000h
11571	12W LED	3000K	750 lm	110°	>90	~220-230 V, 50/60 Hz	⊕	>0.7	IP54	30000h
11572	15W LED	3000K	1100 lm	110°	>90	~220-230 V, 50/60 Hz	⊕	>0.7	IP54	30000h
11573	15W LED	3000K	1100 lm	110°	>90	~220-230 V, 50/60 Hz	⊕	>0.7	IP54	30000h
11574	15W LED	3000K	1100 lm	110°	>90	~220-230 V, 50/60 Hz	⊕	>0.7	IP54	30000h

Can be used in the bathroom

■ BLACK ■ SAND ■ BRICK RED

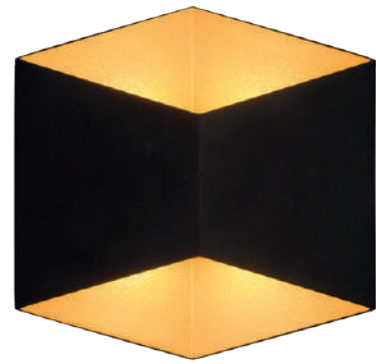

TRIANGLES LED 8141

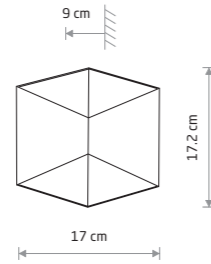

TRIANGLES LED

Painted aluminum, glass

8143 8142 8141

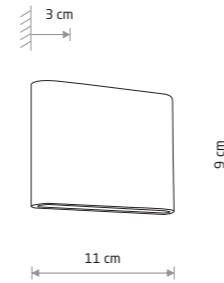

SEMI LED

Painted aluminum, glass

6775 11363 11365



ELLIPSES LED 8182

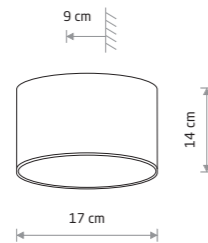

ELLIPSES LED

Painted aluminum, glass

8140 8182

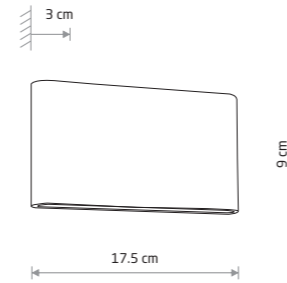

SEMI LED M

Painted aluminum, glass

11364 11366



SEMI LED M 11366

Item No.	Power	Colour temp.	Luminous flux	Beam angle	Colour Rendering Index (CRI)	Input	Safety type	Power factor	Ingress protection	Lifetime
8140	2x5W LED	3000K	800 lm	180°	≥80	~220-230 V, 50/60 Hz	⊕	>0.5	IP54	10000h
8141	2x5W LED	3000K	750 lm	180°	≥80	~220-230 V, 50/60 Hz	⊕	>0.5	IP54	10000h
8142	2x5W LED	3000K	700 lm	180°	≥80	~220-230 V, 50/60 Hz	⊕	>0.5	IP54	10000h
8143	2x5W LED	3000K	800 lm	180°	≥80	~220-230 V, 50/60 Hz	⊕	>0.5	IP54	10000h
8182	2x5W LED	3000K	700 lm	180°	≥80	~220-230 V, 50/60 Hz	⊕	>0.5	IP54	10000h

Item No.	Power	Colour temp.	Luminous flux	Beam angle	Colour Rendering Index (CRI)	Input	Safety type	Power factor	Ingress protection	Lifetime
6775	2x3W LED	3000K	242 lm	40°	≥80	~220-230 V, 50/60 Hz	⊕	>0.5	IP54	8000h
11363	2x3W LED	3000K	300 lm	40°	>80	~220-230 V, 50/60 Hz	⊕	>0.5	IP54	30000h
11364	2x5W LED	3000K	500 lm	40°	>80	~220-230 V, 50/60 Hz	⊕	>0.5	IP54	30000h
11365	2x3W LED	3000K	300 lm	40°	>80	~220-230 V, 50/60 Hz	⊕	>0.5	IP54	30000h
11366	2x5W LED	3000K	500 lm	40°	>80	~220-230 V, 50/60 Hz	⊕	>0.5	IP54	30000h

WHITE BLACK-GOLD BLACK

Can be used in the bathroom

GRAPHITE BLACK BRASS



MARGOT 10504

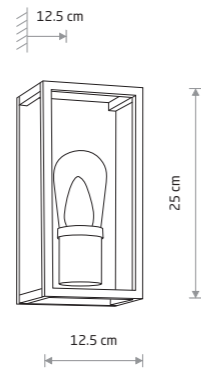

MARGOT

■ painted aluminum, glass

■ 10504

● 1xE14, max 10W only LED

IP54



LENS LED 9112



MARGOT 10503

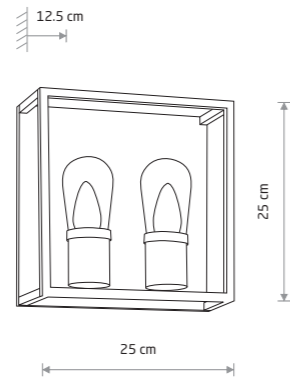

MARGOT

■ painted aluminum, glass

■ 10503

● 2xE14, max 10W only LED

IP54

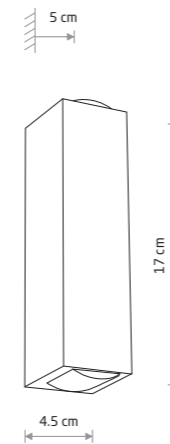

LENS LED

■ painted aluminum, glass

■ 9112 □ 9113



Item No.	Power	Colour temp.	Luminous flux	Beam angle	Colour Rendering Index (CRI)	Input	Safety type	Power factor	Ingress protection	Lifetime
9112	2x2W LED	3000K	40 lm	10°	≥ 80	~220-230 V, 50/60 Hz	⊕	>0.5	IP54	10000h
9113	2x2W LED	3000K	59 lm	10°	≥ 80	~220-230 V, 50/60 Hz	⊕	>0.5	IP54	10000h



ASSOS 9123

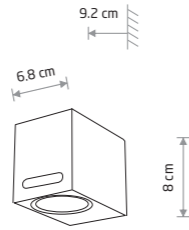

ASSOS

■ painted aluminum, glass

■ 9123

🔌 1xGU10 R50, max 10W only LED

IP54

ARRIS

■ painted aluminum, glass

■ 9516

🔌 1xGU10 R50, max 10W only LED

IP54

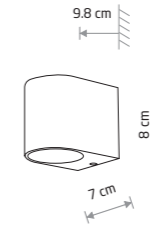

ARRIS 9516



ASSOS 9124

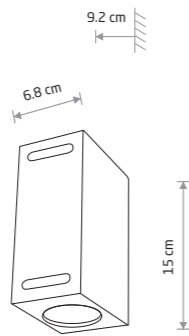

ASSOS

■ painted aluminum, glass

■ 9124

🔌 2xGU10 R50, max 10W only LED

IP54

NICO

■ painted aluminum, glass

■ 9518

🔌 1xGU10 R50, max 10W only LED

IP54

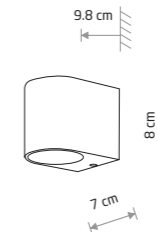

NICO 9518



PRIMM 9551

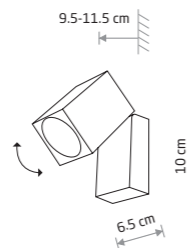

PRIMM

■ painted aluminum, glass

■ 9551

🔌 1xGU10 R50, max 10W only LED

IP54

NICO

■ painted aluminum, glass

■ 9517

🔌 2xGU10 R50, max 10W only LED

IP54

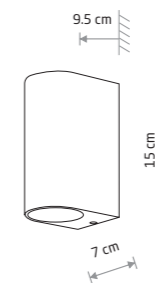

NICO 9517

FOG 3403

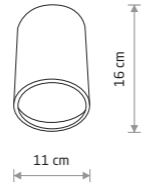

FOG

■ painted aluminum, glass

■ 3403

■ 1xE27, max 25W only LED

IP44

FOG 3402

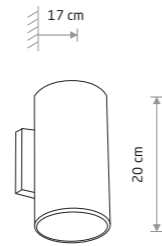

FOG

■ painted aluminum, glass

■ 3402

■ 1xE27, max 25W only LED

IP44

FOG 3404

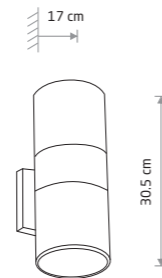

FOG

■ painted aluminum, glass

■ 3404

■ 2xE27, max 25W only LED

IP44

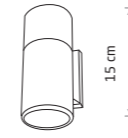

NEGRO

■ painted aluminum, glass

■ 4425

■ 1xGU10 R50, max 10W only LED

IP54



NEGRO 4425

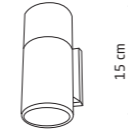

EXE

■ painted aluminum, glass

■ 8331

■ 1xGU10 R50, max 10W only LED

IP54



EXE 8331

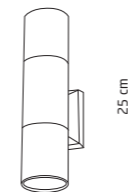

EXE

■ painted aluminum, glass

■ 8330

■ 2xGU10 R50, max 10W only LED

IP54

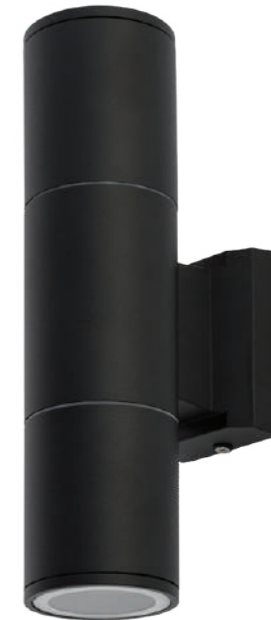

EXE 8330



ROCK PRO 10687

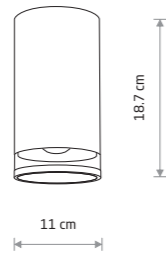

ROCK PRO

■ painted aluminum, plastic PC

■ 10687

● 1xE27, max 25W only LED

IP44



ROCK PRO 10686

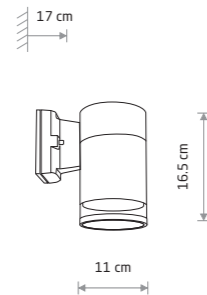

ROCK PRO

■ painted aluminum, plastic PC

■ 10686

● 1xE27, max 25W only LED

IP44



ROCK PRO 10688

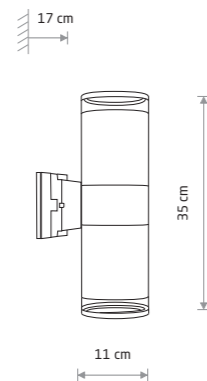

ROCK PRO

■ painted aluminum, plastic PC

■ 10688

● 2xE27, max 25W only LED

IP44



SIERRA 4422

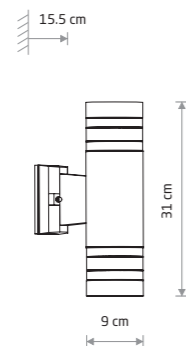

SIERRA

■ painted aluminum, plastic PC

■ 4422

● 2xE27, max 25W only LED

IP54



HEXA 9565

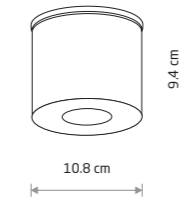

HEXA

■ painted aluminum, glass

□ 9564 ■ 9565

● 1xGU10 R50, max 10W only LED

IP44



EDESA LED M 9108

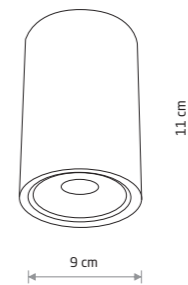

EDESA LED M

■ painted aluminum, glass

□ 9108 ■ 9107



EDESA LED S 9111

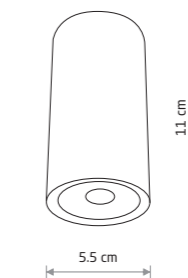

EDESA LED S

■ painted aluminum, glass

□ 9111

Item No.	Power	Colour temp.	Luminous flux	Beam angle	Colour Rendering Index (CRI)	Input	Safety type	Power factor	Ingress protection	Lifetime
9107	7W LED	3000K	530 lm	19°	≥ 80	~220-230 V, 50/60 Hz	⊕	>0.5	IP54	10000h
9108	7W LED	3000K	530 lm	19°	≥ 80	~220-230 V, 50/60 Hz	⊕	>0.5	IP54	10000h
9111	3W LED	3000K	250 lm	30°	≥ 80	~220-230 V, 50/60 Hz	⊕	>0.5	IP54	10000h

QUARTZ 3411

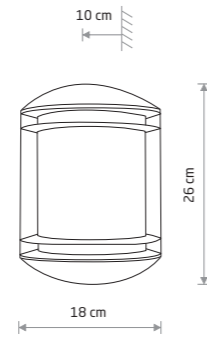

QUARTZ

■ painted aluminum, plastic PC

■ 3411

■ 1xE27, max 10W only LED

IP21

ORINOKO 4387

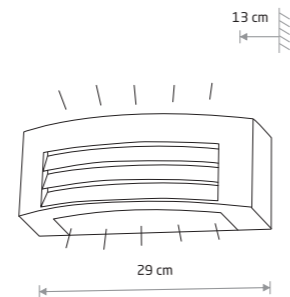
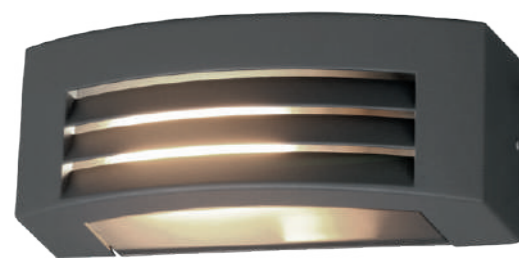

ORINOKO

■ painted aluminum, plastic PC

■ 4387

■ 1xE27, max 10W only LED

IP44

CABO LED

■ painted aluminum, plastic PC

■ 11804 ■ 11805

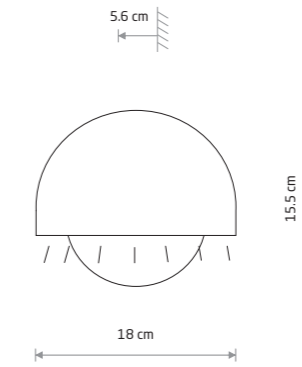

CABO LED 11804

UNIT LED

■ painted aluminum, glass

■ 9122

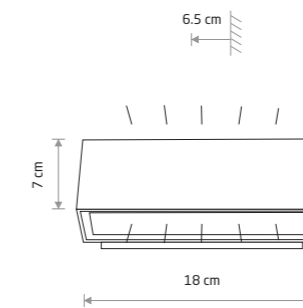

UNIT LED 9122

BRICK

■ painted aluminum, glass

■ 3408

■ 1xE27, max 25W only LED

IP65

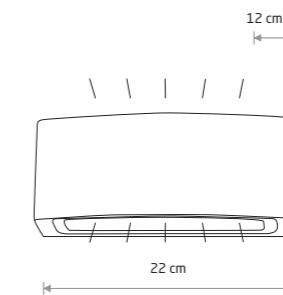

BRICK 3408

Item No.	Power	Colour temp.	Luminous flux	Beam angle	Colour Rendering Index (CRI)	Input	Safety type	Power factor	Ingress protection	Lifetime
11804	10W LED	3000K	800 lm	120°	>90	220-230 V, 50/60 Hz	⊕	>0.5	IP54	30000h
11805	10W LED	3000K	900 lm	120°	>90	220/230 V, 50/60 Hz	⊕	>0.5	IP54	30000h
9122	2x5W LED	3000K	727 lm	110°	≥ 80	~220-230 V, 50/60 Hz	⊕	>0.9	IP54	20000h



OSCAR 11347

OSCAR
painted aluminum

■ 11346 □ 11347

🔌 1xGU10 R50, max 15W only LED

IP54

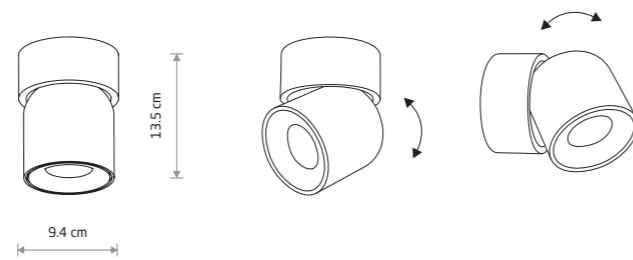

■ BLACK □ WHITE

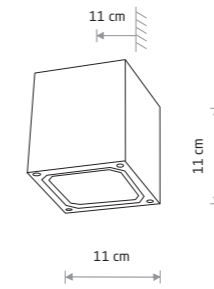

KHUMBU

painted aluminum, glass

■ 4443

🔌 1xG9, max 10W only LED

IP44



KHUMBU 4443

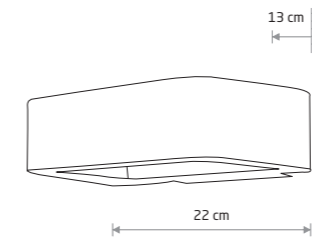

MUNO LED

painted aluminum, glass

■ 6776



MUNO LED 6776

Item No.	Power	Colour temp.	Luminous flux	Beam angle	Colour Rendering Index (CRI)	Input	Safety type	Power factor	Ingress protection	Lifetime
6776	6W LED	3000K	240 lm	120°	≥ 80	~220-230 V, 50/60 Hz	⊕	>0.5	IP54	8000h

■ GRAPHITE



PICNIC LED 8177

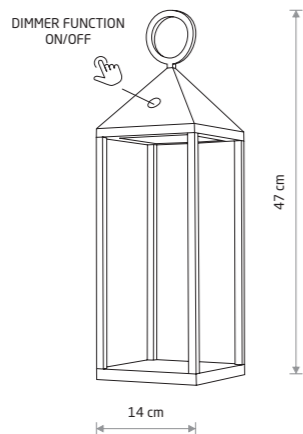

PICNIC LED
painted aluminum, plastic PC

8178 8177

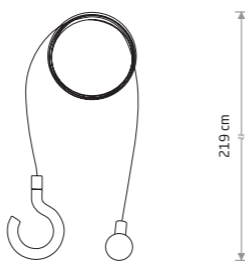

HANGING SET
FOR PICNIC LED

aluminum, steel

8107 8106

Lampa bezprzewodowa, przenośna, zewnętrzna

- Podstawa ładująca w komplecie
- Akumulator litowy 2×2200 mAh
- Czas pełnego ładowania 5-8 h
- Czas pracy 12 h
- Włącznik dotykowy
- Ściemniacz

Wireless lamp, portable, outdoor

- Charging base (set incl.)
- 2×2200 mAh lithium battery
- Full charge time 5-8h
- Work time 12 h
- Touch switch
- Dimmable

Item No.	Power	Colour temp.	Luminous flux	Beam angle	Colour Rendering Index (CRI)	Input	Safety type	Ingress protection	Lifetime
8177	2.2W LED	3000K	155 lm	46°	≥84	~220-230 V, 50/60 Hz	☐	IP54	30000h
8178	2.2W LED	3000K	155 lm	46°	≥84	~220-230 V, 50/60 Hz	☐	IP54	30000h

WHITE GRAPHITE



PICNIC LED 8178

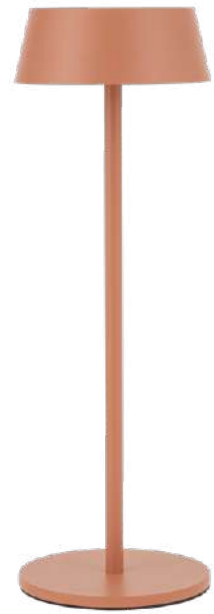

AMY LED 11534



AMY LED 11535



AMY LED 11533

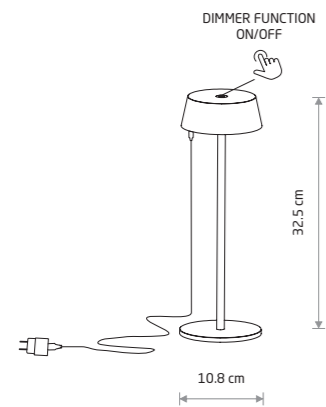

AMY LED

Painted aluminum, plastic PC

- 11531
 11532
 11533
- 11534
 11535

Lampa bezprzewodowa, przenośna, zewnętrzna

- Ładowarka USB C (w zestawie)
- Włącznik dotykowy
- Ściemniacz 10-100%

Wireless lamp, portable, outdoor

- Power adapter USB C (set incl.)
- Touch switch
- Dimmable 10-100%

Item No.	Power	Colour temp.	Luminous flux	Beam angle	Colour Rendering Index (CRI)	Voltage DC	Safety type	Ingress protection	Lifetime
11531	2W LED	3000K	170 lm	45°	>80	5V	⚡	IP54	30000h
11532	2W LED	3000K	170 lm	45°	>80	5V	⚡	IP54	30000h
11533	2W LED	3000K	170 lm	45°	>80	5V	⚡	IP54	30000h
11534	2W LED	3000K	170 lm	45°	>80	5V	⚡	IP54	30000h
11535	2W LED	3000K	170 lm	45°	>80	5V	⚡	IP54	30000h



AMY LED 11534

- WHITE
 BLACK
 SAND
 BRICK RED
 GREEN



NALA LED 11536

Lampa bezprzewodowa, przenośna, zewnętrzna

- Ładowarka USB C (w zestawie)
- Włącznik dotykowy
- Ściemniacz 10-100%

Wireless lamp, portable, outdoor

- Power adapter USB C (set incl.)
- Touch switch
- Dimmable 10-100%

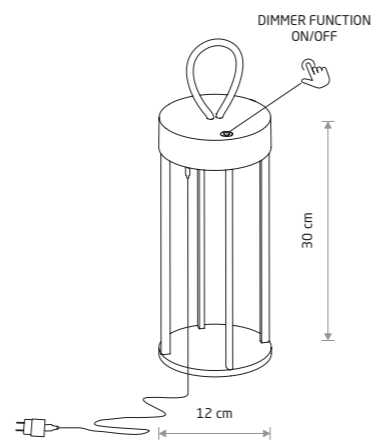

NALA LED

painted aluminum, plastic PC

- 11536 □ 11537

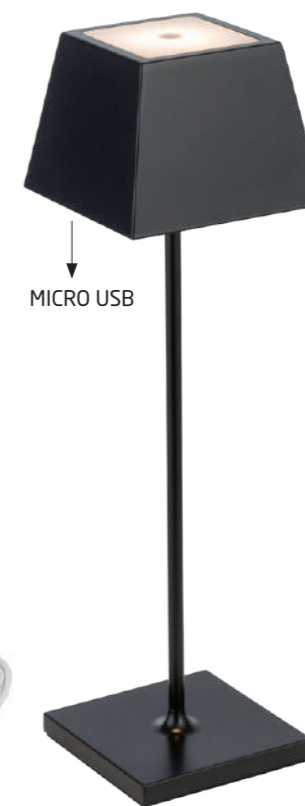

MAHE LED 8398

Lampa bezprzewodowa, przenośna, zewnętrzna

- Ładowarka MICRO USB (w zestawie)
- Czas pełnego ładowania 5-7 h
- Czas pracy 9 h
- Włącznik dotykowy
- Ściemniacz

Wireless lamp, portable, outdoor

- Power adapter MICRO USB (set incl.)
- Full charge time 5-7 h
- Work time 9 h
- Touch switch
- Dimmable

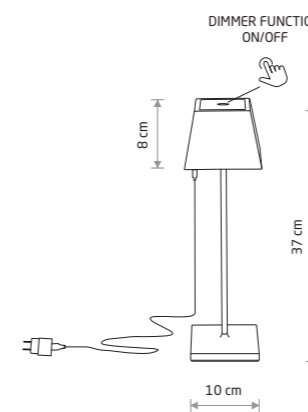

MAHE LED

painted aluminum, plastic PC

- 8397 ■ 8398



Item No.	Power	Colour temp.	Luminous flux	Beam angle	Colour Rendering Index (CRI)	Voltage DC	Safety type	Ingress protection	Lifetime
11536	4W LED	2700K	170 lm	45°	>80	5V	⚡	IP54	30000h
11537	4W LED	2700K	170 lm	45°	>80	5V	⚡	IP54	30000h

Item No.	Power	Colour temp.	Luminous flux	Beam angle	Colour Rendering Index (CRI)	Input	Safety type	Ingress protection	Lifetime
8397	2.2W LED	3000K	168 lm	46°	≥ 84	~220-230 V, 50/60 Hz	⚡	IP54	25000h
8398	2.2W LED	3000K	168 lm	46°	≥ 84	~220-230 V, 50/60 Hz	⚡	IP54	25000h



PUEBLA LED 9513

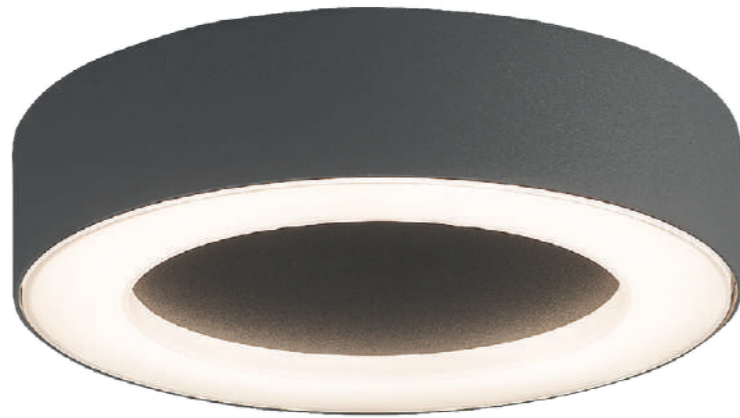

MERIDA LED 9514

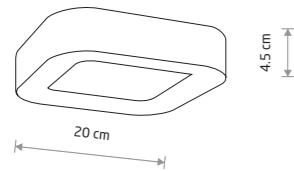

PUEBLA LED
 painted aluminum, plastic PC
 ■ 9513

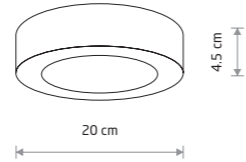

MERIDA LED
 painted aluminum, plastic PC
 ■ 9514

Item No.	Power	Colour temp.	Luminous flux	Beam angle	Colour Rendering Index (CRI)	Input	Safety type	Power factor	Ingress protection	Lifetime
9513	12W LED	3000K	540 lm	110°	≥ 80	~220-230 V, 50/60 Hz	⊕	>0.9	IP54	20000h
9514	12W LED	3000K	540 lm	110°	≥ 80	~220-230 V, 50/60 Hz	⊕	>0.9	IP54	20000h



PIX LED 11367

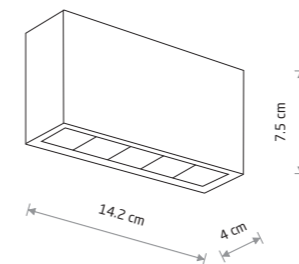

PIX LED
 painted aluminum, glass
 ■ 11367

Item No.	Power	Colour temp.	Luminous flux	Beam angle	Colour Rendering Index (CRI)	Input	Safety type	Power factor	Ingress protection	Lifetime
11367	10W LED	3000K	500 lm	30°	>80	~220-230 V, 50/60 Hz	⊕	>0.5	IP54	30000h



OUTLINE LED S
11360

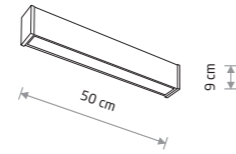

OUTLINE LED S
painted aluminum, plastic PC

■ 11360

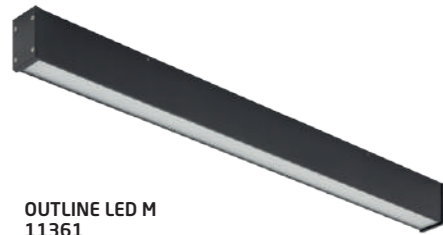

OUTLINE LED M
11361

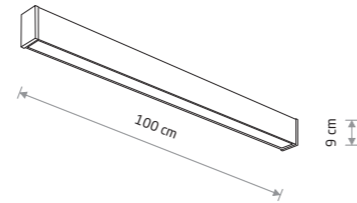

OUTLINE LED M
painted aluminum, plastic PC

■ 11361

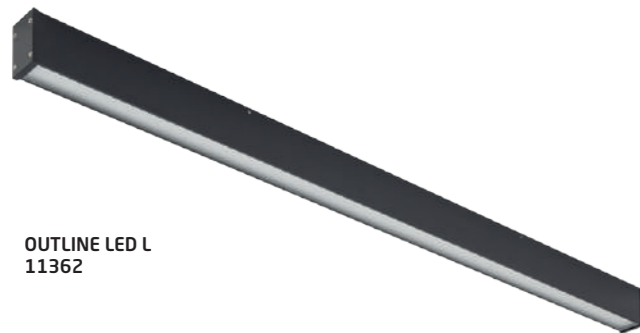

OUTLINE LED L
11362

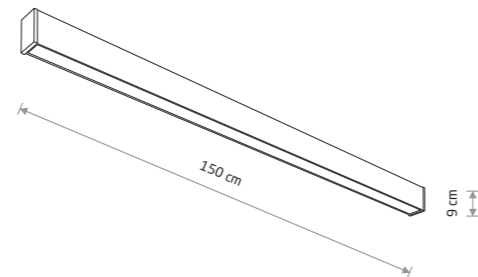

OUTLINE LED L
painted aluminum, plastic PC

■ 11362



OUTLINE LED S 11360

Item No.	Power	Colour temp.	Luminous flux	Beam angle	Colour Rendering Index (CRI)	Input	Safety type	Power factor	Ingress protection	Lifetime
11360	20W LED	3000K	1200 lm	100°	>80	~220-230 V, 50/60 Hz	⊕	>0.9	IP44	30000h
11361	35W LED	3000K	1800 lm	100°	>80	~220-230 V, 50/60 Hz	⊕	>0.9	IP44	30000h
11362	50W LED	3000K	3000 lm	100°	>80	~220-230 V, 50/60 Hz	⊕	>0.9	IP44	30000h

■ BLACK



CLINE LED 11377



CLINE LED 11377

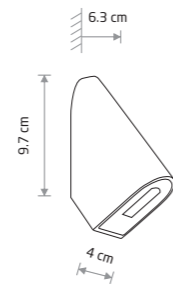

CLINE LED

■ painted aluminum, glass

■ 11377



Item No.	Power	Colour temp.	Luminous flux	Beam angle	Colour Rendering Index (CRI)	Input	Safety type	Power factor	Ingress protection	Lifetime
11377	3W LED	3000K	130 lm	80 °	>80	~220-230 V, 50/60 Hz	⊕	>0.5	IP54	30000h

■ BLACK



ABBY LED 11528



AVA LED 11530

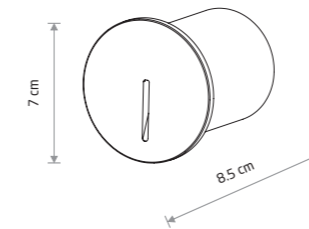

ABBY LED

■ painted aluminum, plastic PC

■ 11528



🔧 cut out ø 58 mm

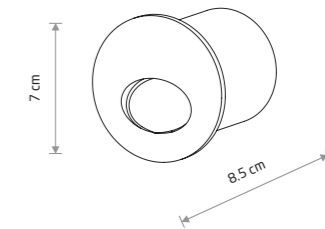

AVA LED

■ painted aluminum, plastic PC

■ 11530



🔧 cut out ø 58 mm

Item No.	Power	Colour temp.	Luminous flux	Beam angle	Colour Rendering Index (CRI)	Input	Safety type	Power factor	Ingress protection	Lifetime
11528	3W LED	3000K	10 lm	20 °	>80	~220-230 V, 50/60 Hz	⊕	>0.5	IP54	30000h
11530	3W LED	3000K	40 lm	40 °	>80	~220-230 V, 50/60 Hz	⊕	>0.5	IP54	30000h

■ BLACK



BAY LED 8164



BAY LED 8165



SIDEWALK SQUARE LED 8148



SIDEWALK ROUND LED 8147

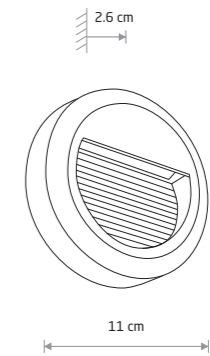
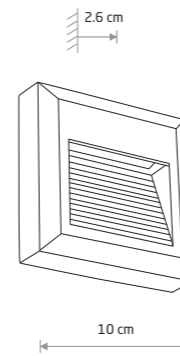
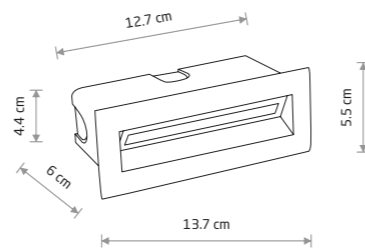
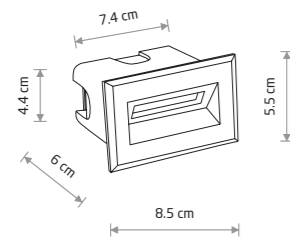

BAY LED

■ painted aluminum, plastic PC

■ 8164



BAY LED

■ painted aluminum, plastic PC

■ 8165



SIDEWALK SQUARE LED

■ painted aluminum, plastic PC

■ 8148



SIDEWALK ROUND LED

■ painted aluminum, plastic PC

■ 8147



Item No.	Power	Colour temp.	Luminous flux	Beam angle	Colour Rendering Index (CRI)	Input	Safety type	Power factor	Ingress protection	Lifetime
8164	3W LED	3000K	200 lm	70°	≥80	~220-230 V, 50/60 Hz	⊕	>0.5	IP65	10000h
8165	5W LED	3000K	360 lm	70°	≥80	~220-230 V, 50/60 Hz	⊕	>0.5	IP65	10000h

Item No.	Power	Colour temp.	Luminous flux	Beam angle	Colour Rendering Index (CRI)	Input	Safety type	Power factor	Ingress protection	Lifetime
8147	3W LED	3000K	100 lm	120°	≥80	~220-230 V, 50/60 Hz	⊕	>0.5	IP54	20000h
8148	3W LED	3000K	100 lm	120°	≥80	~220-230 V, 50/60 Hz	⊕	>0.5	IP54	20000h



BASALT 3412

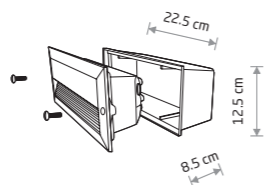

BASALT
painted aluminum, plastic

■ 3412
 ⚡ 1xE14, max 10W only LED
 IP44

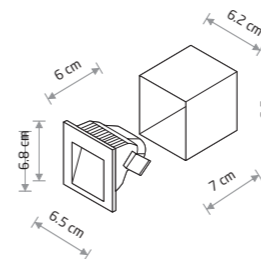

STEP LED
painted aluminum, plastic

■ 6907 □ 6908



STEP LED 6907



ASSAM 4453

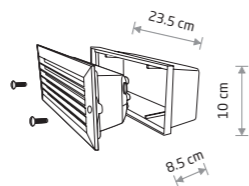

ASSAM
painted aluminum, glass, plastic

■ 4453
 ⚡ 1xE27, max 10W only LED
 IP65

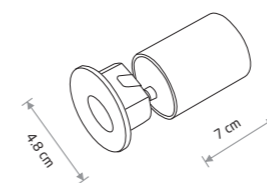

OIA LED
painted aluminum, plastic

■ 9102 □ 9103

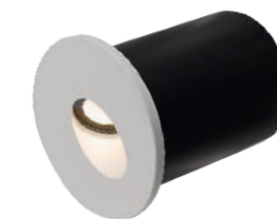

OIA LED 9103

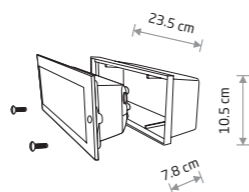

INA
painted aluminum, glass, plastic

■ 4907
 ⚡ 1xE27, max 10W only LED
 IP65



INA 4907

Item No.	Power	Colour temp.	Luminous flux	Beam angle	Colour Rendering Index (CRI)	Input	Safety type	Power factor	Ingress protection	Lifetime
9102 9103	2W LED	3000K	50 lm	50°	≥ 80	~220-230 V, 50/60 Hz	⊕	>0.5	IP20	10000h
6907	3W LED	3000K	120 lm	92°	≥ 80	~220-230 V, 50/60 Hz	⊕	>0.5	IP44	10000h
6908	3W LED	3000K	190 lm	92°	≥ 80	~220-230 V, 50/60 Hz	⊕	>0.5	IP44	10000h



BUSH 3401

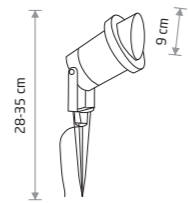

BUSH

■ painted aluminum, glass

■ 3401

● 1xGU10 R50, max 10W only LED

IP65



SPIKE LED S 9101

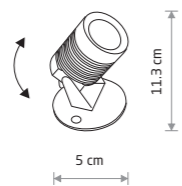

SPIKE LED S

■ painted aluminum, glass

■ 9101



SPIKE LED M 9100

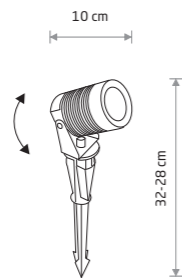

SPIKE LED M

■ painted aluminum, glass, plastic

■ 9100



Item No.	Power	Colour temp.	Luminous flux	Beam angle	Colour Rendering Index (CRI)	Input	Safety type	Power factor	Ingress protection	Lifetime
9100	5W LED	3000K	300 lm	30°	>80	~220-230 V, 50/60 Hz	⊕	>0.5	IP54	10000h
9101	5W LED	3000K	300 lm	30°	>80	~220-230 V, 50/60 Hz	⊕	>0.5	IP54	10000h

■ BLACK ■ GRAPHITE



RUMI LED 11543

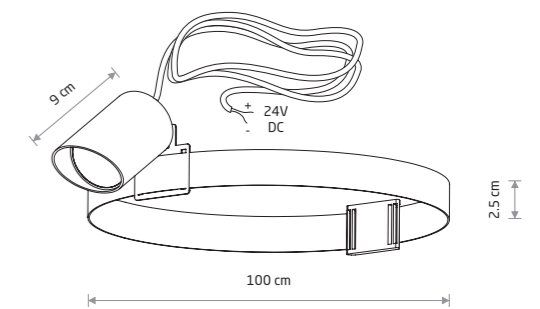

RUMI LED

■ painted aluminum, plastic PC

■ 11543



Item No.	Power	Colour temp.	Luminous flux	Beam angle	Colour Rendering Index (CRI)	Voltage DC	Safety type	Ingress protection	Lifetime
11543	7W LED	3000K	320 lm	50°	>90	24V	⚡	IP54	30000h

■ BLACK



PICCO LED S 9106

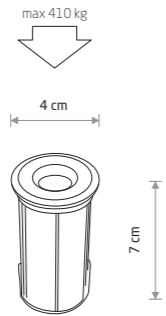

PICCO LED S

aluminum

9106



cut out ø 38 mm

PAOLI 9554



MON LED 4454

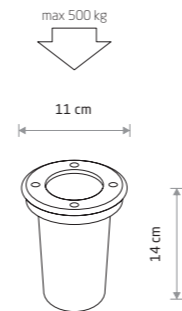

PAOLI

steel, glass

9554



1xGU10 R50, max 10W only LED

cut out ø 100 mm

IP67

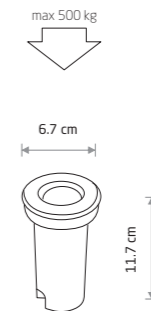

MON LED

aluminum, glass

4454



cut out ø 64 mm



PICCO LED M 9105

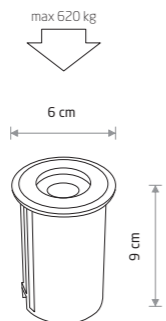

PICCO LED M

aluminum

9105



cut out ø 55 mm



PAT LED 8162

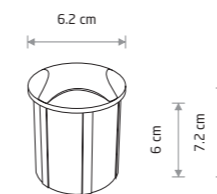
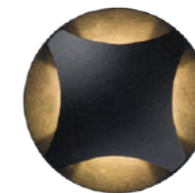

PAT LED

painted aluminum, plastic PC

8162



cut out ø 56 mm



CIRCLLET LED 8163

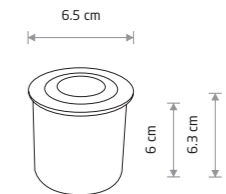

CIRCLLET LED

painted aluminum, plastic PC

8163



cut out ø 57 mm



PICCO LED L 9104

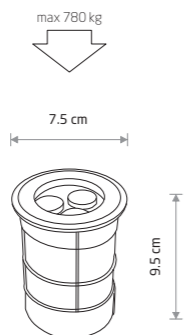

PICCO LED L

aluminum

9104



cut out ø 65 mm

Item No.	Power	Colour temp.	Luminous flux	Beam angle	Colour Rendering Index (CRI)	Input	Safety type	Power factor	Ingress protection	Lifetime
9106	2W LED	3000K	60 lm	25°	≥ 80	~220-230 V, 50/60 Hz	⊕	>0.5	IP67	10000h
9105	2W LED	3000K	80 lm	25°	≥ 80	~220-230 V, 50/60 Hz	⊕	>0.5	IP67	10000h
9104	3W LED	3000K	200 lm	25°	≥ 80	~220-230 V, 50/60 Hz	⊕	>0.5	IP67	10000h

Item No.	Power	Colour temp.	Luminous flux	Beam angle	Colour Rendering Index (CRI)	Input	Safety type	Power factor	Ingress protection	Lifetime
4454	2W LED	3000K	100 lm	30°	≥ 80	~220-230 V, 50/60 Hz	⊕	>0.5	IP67	10000h
8162	3W LED	3000K	12 lm	25°	≥ 80	~220-230 V, 50/60 Hz	⊕	>0.5	IP65	10000h
8163	3W LED	3000K	120 lm	50°	≥ 80	~220-230 V, 50/60 Hz	⊕	>0.5	IP65	10000h



ANA 10499

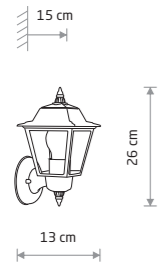

ANA
painted aluminum, plastic PC

■ 10499

🔌 1xE27, max 10W only LED

IP44



ANA 10500

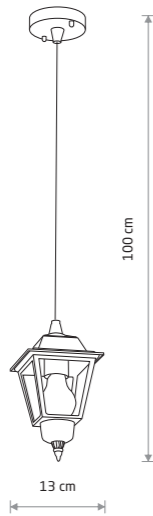

ANA
painted aluminum, plastic PC

■ 10500

🔌 1xE27, max 10W only LED

IP44

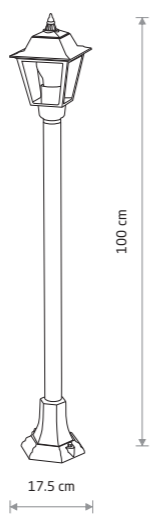

ANA
painted aluminum, plastic PC

■ 10501

🔌 1xE27, max 10W only LED

IP44

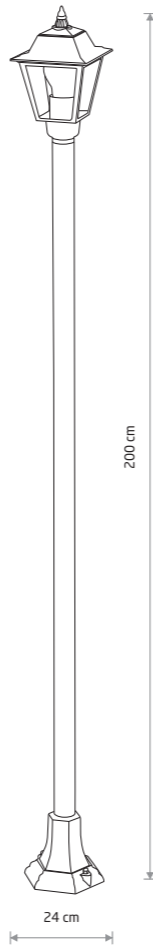

ANA
painted aluminum, plastic PC

■ 10502

🔌 1xE27, max 10W only LED

IP44



AMELIA 10495

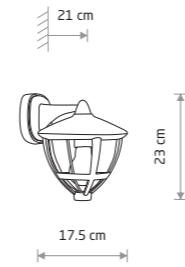

AMELIA
painted aluminum, plastic PC

■ 10495

🔌 1xE27, max 10W only LED

IP44



AMELIA 10496



AMELIA BL
painted aluminum, plastic PC

■ 10496

🔌 1xE27, max 10W only LED

IP44

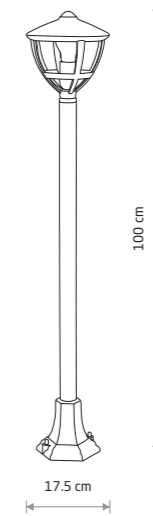

AMELIA
painted aluminum, plastic PC

■ 10497

🔌 1xE27, max 10W only LED

IP44

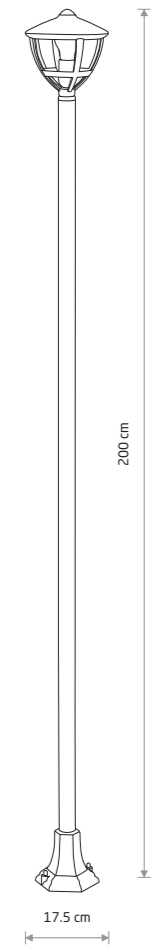

AMELIA
painted aluminum, plastic PC

■ 10498

🔌 1xE27, max 10W only LED

IP44



AMUR 4692

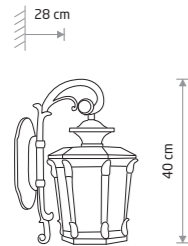

AMUR

■ painted aluminum, glass

■ 4692

■ 1xE27, max 25W only LED

IP23

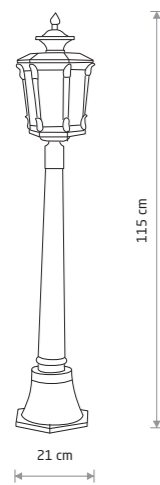

AMUR

■ painted aluminum, glass

■ 4694

■ 1xE27, max 25W only LED

IP44



TAY 5292

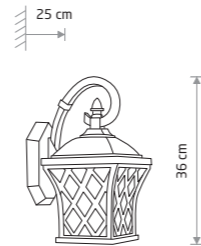

TAY

■ painted aluminum, glass

■ 5292

■ 1xE27, max 25W only LED

IP23

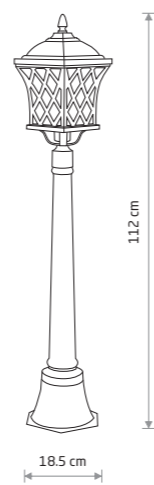

TAY

■ painted aluminum, glass

■ 5294

■ 1xE27, max 25W only LED

IP23

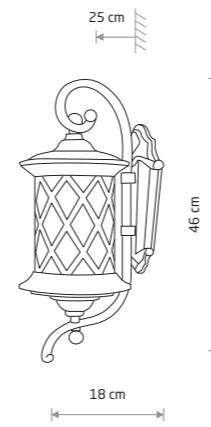

LANTERN

■ painted aluminum, plastic PC

■ 6911

■ 1xE27, max 25W only LED

IP23



LANTERN 6911

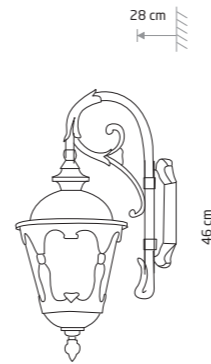

TYBR

■ painted aluminum, glass

■ 4686

■ 1xE27, max 25W only LED

IP44



TYBR 4686

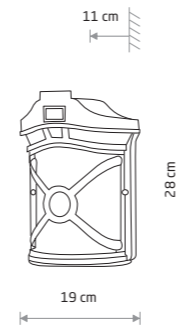

DON

■ painted aluminum, glass

■ 4687

■ 1xE27, max 25W only LED

IP44



DON 4687



NOOK 7976

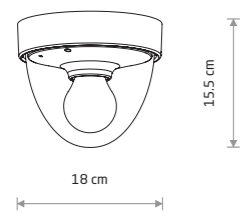

NOOK

plastic ABS, plastic PC

7972 7976 7978

1xE27, max 10W only LED

IP44

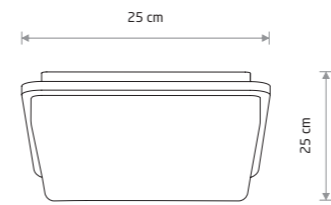

TAHOE II

plastic PC, plastic ABS

10035 10037 10038

2xE27, max 15W only LED

IP44



TAHOE II 10038

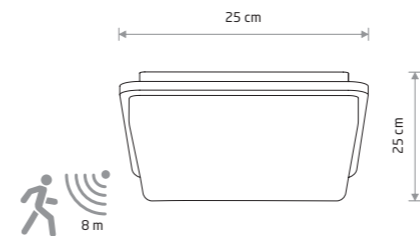

TAHOE SENSOR

plastic PC, plastic ABS

10040

2xE27, max 15W only LED

IP44



TAHOE SENSOR 10040



FESTOON LIGHTS 9 M 7872

FESTOON LIGHTS 6 M 7873



MAX 2000W MAX 80m CONNECTABLE

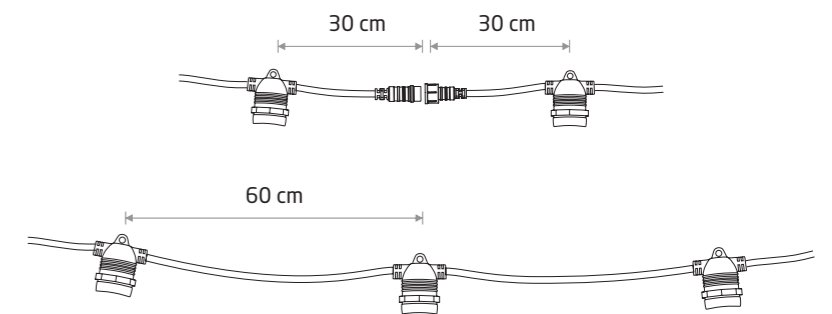
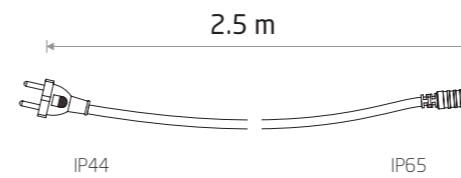

**POWER CORD FOR
FESTOON LIGHTS**
rubber cable

- 7871 IP65

FESTOON LIGHTS 6M
rubber cable

- 7873 IP65
- 💡 10xE27, max 15W

FESTOON LIGHTS 9M
rubber cable

- 7872 IP65
- 💡 15xE27, max 15W



5 PC SET

**BULB LED E27, A60 2W,
5 PC SET**

- glass
- 7487





BULB LED G9, 7W 9197

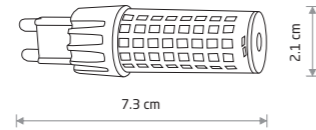

BULB LED G9, 7W

ceramic housing, plastic PC

☐ 9197 3000K ☐ 10933 4000K



BULB LED G9, 4W 7504

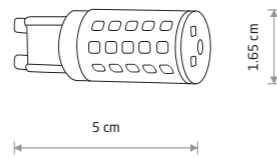

BULB LED G9, 4W

plastic PC

☐ 7503 3000K ☐ 7504 4000K



BULB LENS LED, G9, 3W 9173

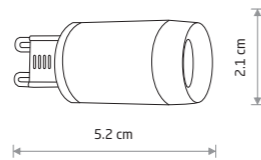

BULB LENS LED, G9, 3W

ceramic housing, plastic PC

☐ 9173 3000K ☐ 8447 4000K



REFLECTOR LED, GU10, R35, 4W 10230

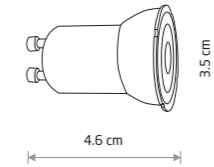

REFLECTOR LED, GU10, R35, 4W

plastic PC

☐ 10230 3000K ☐ 10231 4000K



REFLECTOR LED, GU10, R50, 7W 8347

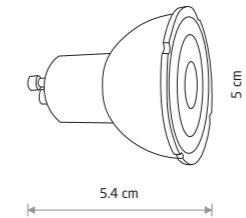

REFLECTOR LED, GU10, R50, 7W

plastic PC

☐ 9180 3000K ☐ 9178 4000K

■ 8348 3000K ■ 8347 4000K



REFLECTOR LED, GU10, R50, 7W, DIMMABLE 10995

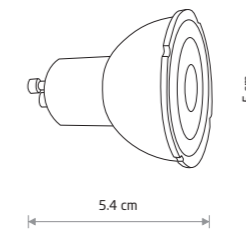

REFLECTOR LED, GU10, R50, 7W, DIMMABLE

plastic PC

☐ 10996 3000K ☐ 10998 4000K

■ 10995 3000K ■ 10997 4000K

Item No.	Power	Colour temp.	Luminous flux	Beam angle	Colour Rendering Index (CRI)	Input	Power factor	Lifetime
9197	7W LED	3000K	750 lm	360°	≥ 80	~220-230 V, 50/60 Hz	>0.5	25000h
10933	7W LED	4000K	900 lm	360°	≥ 80	~220-230 V, 50/60 Hz	>0.5	25000h
7503	4W LED	3000K	380 lm	360°	≥ 80	~220-230 V, 50/60 Hz	>0.5	25000h
7504	4W LED	4000K	390 lm	360°	≥ 80	~220-230 V, 50/60 Hz	>0.5	25000h
9173	3W LED	3000K	330 lm	90°	≥ 80	~220-230 V, 50/60 Hz	>0.5	25000h
8447	3W LED	4000K	310 lm	90°	>80	~220-230 V, 50/60 Hz	>0.5	25000h

Item No.	Power	Colour temp.	Luminous flux	Beam angle	Colour Rendering Index (CRI)	Input	Power factor	Lifetime
9180	7W LED	3000K	600 lm	50°	≥ 80	~220-230 V, 50/60 Hz	>0.7	25000h
9178	7W LED	4000K	600 lm	50°	≥ 80	~220-230 V, 50/60 Hz	>0.7	25000h
8348	7W LED	3000K	600 lm	50°	≥ 80	~220-230 V, 50/60 Hz	>0.7	25000h
8347	7W LED	4000K	600 lm	50°	≥ 80	~220-230 V, 50/60 Hz	>0.7	25000h
10230	4W LED	3000K	370 lm	70°	>80	~220-230 V, 50/60 Hz	>0.5	20000h
10231	4W LED	4000K	400 lm	70°	>80	~220-230 V, 50/60 Hz	>0.5	20000h
10995	7W LED	3000K	600 lm	50°	>80	~220-230 V, 50/60 Hz	>0.7	25000h
10996	7W LED	3000K	600 lm	50°	>80	~220-230 V, 50/60 Hz	>0.7	25000h
10997	7W LED	4000K	600 lm	50°	>80	~220-230 V, 50/60 Hz	>0.7	25000h
10998	7W LED	4000K	600 lm	50°	>80	~220-230 V, 50/60 Hz	>0.7	25000h

☐ WHITE

☐ WHITE ■ BLACK

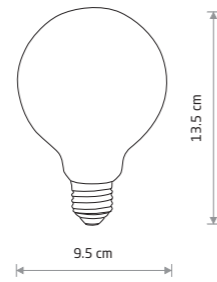

BULB GLASS BALL LED, E27, 8W

glass

9177 3000K

BULB GLASS BALL LED, E27, 8W 9177

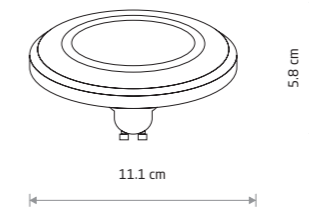

REFLECTOR LENS LED, GU10, ES111, 9W 9345

REFLECTOR LENS LED, GU10, ES111, 9W

plastic

9343 3000K 9213 4000K

9345 3000K 9214 4000K

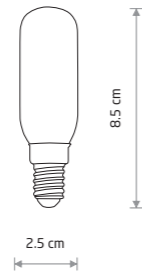

BULB LED E14, T25, 4W

glass

11525 3000K

BULB LED, E14, T25, 4W 11525

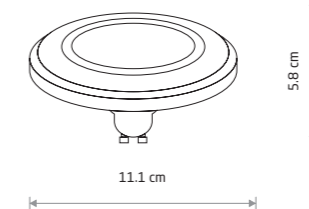

REFLECTOR DIFFUSER LED, GU10, ES111, 9W 9211

REFLECTOR DIFFUSER LED, GU10, ES111, 9W

plastic

9342 3000K 9211 4000K

9344 3000K 9212 4000K

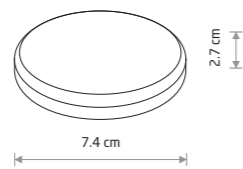

BULB LED GX53, 8W

plastic PC

8377 3000K 8378 4000K

BULB LED, GX53, 8W 8378

Item No.	Power	Colour temp.	Luminous flux	Beam angle	Colour Rendering Index (CRI)	Input	Power factor	Lifetime
8377	8W LED	3000K	680 lm	100°	>80	~220-230 V, 50/60 Hz	>0.5	25000h
8378	8W LED	4000K	700 lm	100°	>80	~220-230 V, 50/60 Hz	>0.5	25000h
9177	8W LED	3000K	840 lm	360°	≥ 80	~220-230 V, 50/60 Hz	>0.5	25000h
11525	4W LED	3000K	400 lm	360°	≥ 80	~220-230 V, 50/60 Hz	>0.5	25000h

Item No.	Power	Colour temp.	Luminous flux	Beam angle	Colour Rendering Index (CRI)	Input	Power factor	Lifetime
9343	9W LED	3000K	770 lm	30°	≥ 80	~220-230 V, 50/60 Hz	>0.5	25000h
9213	9W LED	4000K	870 lm	30°	≥ 80	~220-230 V, 50/60 Hz	>0.5	25000h
9345	9W LED	3000K	870 lm	30°	≥ 80	~220-230 V, 50/60 Hz	>0.5	25000h
9214	9W LED	4000K	930 lm	30°	≥ 80	~220-230 V, 50/60 Hz	>0.5	25000h
9342	9W LED	3000K	790 lm	120°	≥ 80	~220-230 V, 50/60 Hz	>0.5	25000h
9211	9W LED	4000K	900 lm	120°	≥ 80	~220-230 V, 50/60 Hz	>0.5	25000h
9344	9W LED	3000K	790 lm	120°	≥ 80	~220-230 V, 50/60 Hz	>0.5	25000h
9212	9W LED	4000K	900 lm	120°	≥ 80	~220-230 V, 50/60 Hz	>0.5	25000h

WHITE

WHITE BLACK

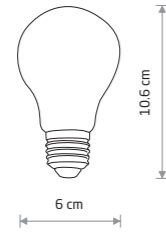

BULB VINTAGE LED E27, 6W
glass
10596

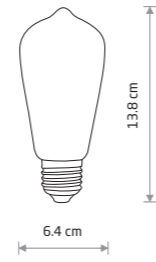

BULB VINTAGE LED E27, 6W
glass
10594

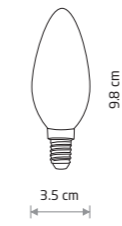

BULB LED E14, C35, 6W
glass
10589

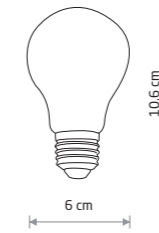

BULB LED E27, A60, 7W
glass
10587

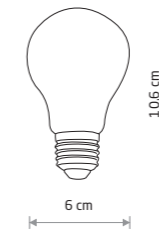

BULB LED E27, A60, 10W
glass
10588

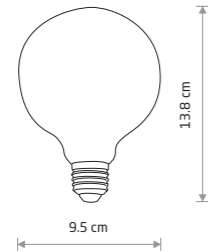

BULB VINTAGE LED E27, 6W
glass
10593

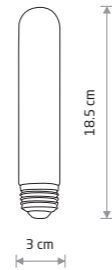

BULB VINTAGE LED E27, 6W
glass
10595



5 PC SET

BULB LED E27, A60 2W, 5 PC SET
glass
7487

Item No.	Power	Colour temp.	Luminous flux	Beam angle	Colour Rendering Index (CRI)	Input	Power factor	Lifetime
10596	6W LED	2200K	580 lm	360°	≥ 80	~220-230 V, 50/60 Hz	>0.5	15000h
10594	6W LED	2200K	560 lm	360°	≥ 80	~220-230 V, 50/60 Hz	>0.5	15000h
10593	6W LED	2200K	550 lm	360°	≥ 80	~220-230 V, 50/60 Hz	>0.5	15000h
10595	6W LED	2200K	450 lm	360°	≥ 80	~220-230 V, 50/60 Hz	>0.5	15000h

Item No.	Power	Colour temp.	Luminous flux	Beam angle	Colour Rendering Index (CRI)	Input	Power factor	Lifetime
10589	6W LED	3000K	650 lm	360°	≥ 80	~220-230 V, 50/60 Hz	>0.5	15000h
10587	7W LED	3000K	800 lm	360°	≥ 80	~220-230 V, 50/60 Hz	>0.5	15000h
10588	10W LED	3000K	1100 lm	360°	≥ 80	~220-230 V, 50/60 Hz	>0.5	15000h
7487	2W LED	2200K	160 lm	360°	≥ 80	~220-230 V, 50/60 Hz	>0.5	15000h

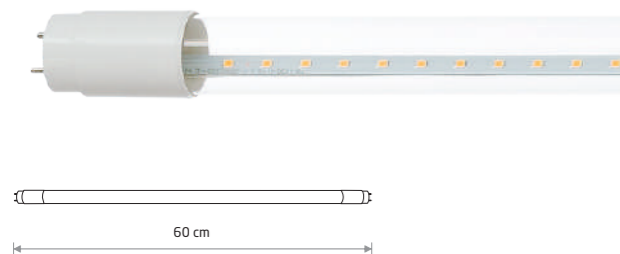

TUBE LED T8, 11W

glass

7500

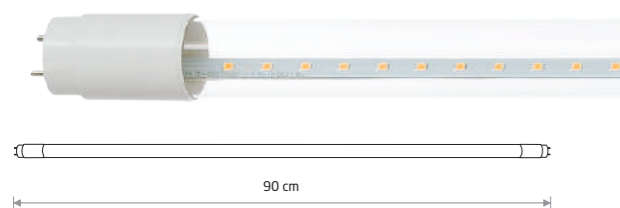

TUBE LED T8, 16W

glass

7501

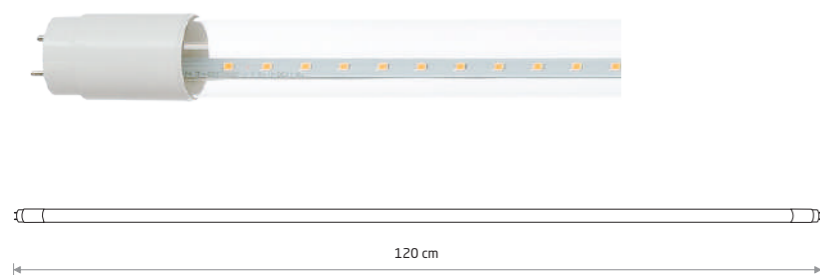

TUBE LED T8, 22W

glass

7502

Item No.	Power	Colour temp.	Leds	Luminous flux	Beam angle	Colour Rendering Index (CRI 2)	Input	Power factor	Lifetime
7500	11W LED	3000K	SMD2835	1700 lm	120°	≥80	~220-230 V, 50/60 Hz	>0.5	30000h
7501	16W LED	3000K	SMD2835	2300 lm	120°	≥80	~220-230 V, 50/60 Hz	>0.5	30000h
7502	22W LED	3000K	SMD2835	3200 lm	120°	≥80	~220-230 V, 50/60 Hz	>0.5	30000h

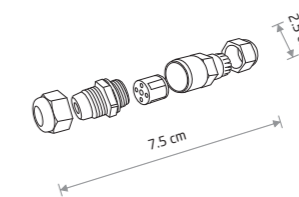

WATERPROOF CONNECTOR IP68

plastic PA

8845

IP68

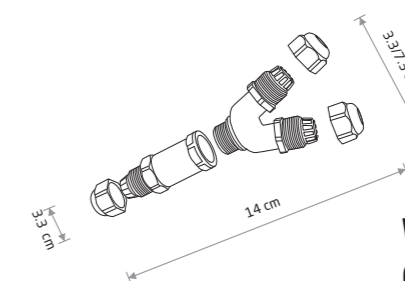

WATERPROOF „Y” CONNECTOR IP68

plastic PA

8846

IP68

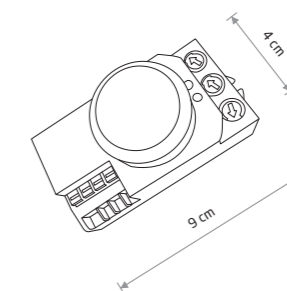

MICROWAVE SENSOR

plastic

8821

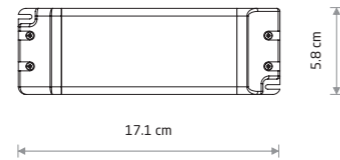

**48V DC, 80W,
POWER SUPPLY**
plastic

11301

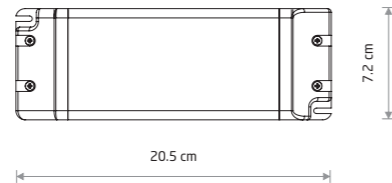

**48V DC, 200W,
POWER SUPPLY**
plastic

11287

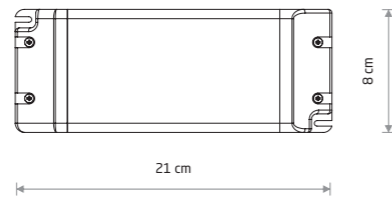

**48V DC, 320W,
POWER SUPPLY**
plastic

11278

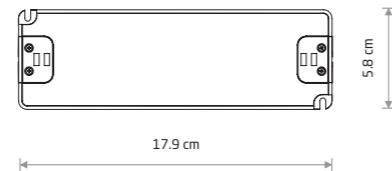

**24V DC, 150W,
POWER SUPPLY**
plastic

11874

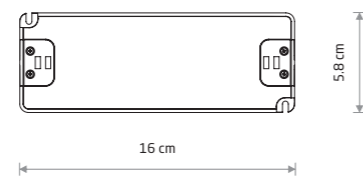

**24V DC, 75W,
POWER SUPPLY**
plastic

11875

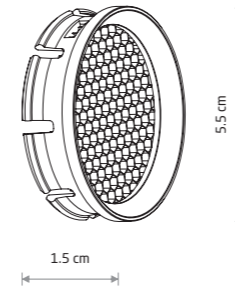

HONEY COMB
aluminum, plastic PA

11427

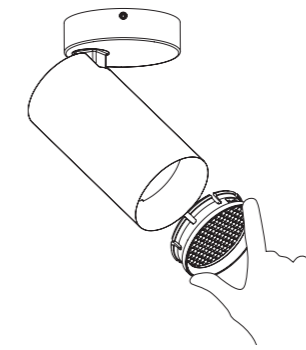

Filtr przeciwośnieniowy "plaster miodu".
Do zastosowania z kolekcją lamp MONO.

Anti-glare "honeycomb".
For use with the MONO lamp collection.

ACROBAT
painted steel

- 11794 □ 11795
- 11796 ■ 11797

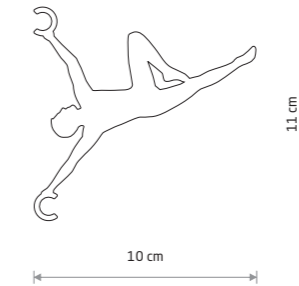

BALLERINA
painted steel

- 11798 □ 11800
- 11801 ■ 11802

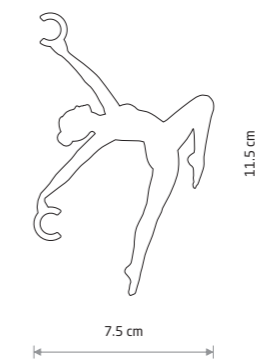

INFORMACJE DLA KLIENTA / CUSTOMER INFORMATION

Informacje ogólne / General information

Rzeczywiste parametry produktów mogą się różnić od wartości deklarowanych w katalogu o +/- 10%.

Zdjęcia prezentowanego asortymentu w niniejszym katalogu mają charakter poglądowy.

Rzeczywisty kolor produktów może nieznacznie odbiegać od prezentowanego na zdjęciach, ze względu na technologię druku.

The actual product parameters may differ from the values declared in the catalogue by +/- 10%.

Photos in this catalogue are for illustrative purposes only.

The actual color of the products may slightly differ from that shown in the photos, due to the printing technology.

Informacje techniczne / Technical information

Temperatura barwowa (K) - w potocznym rozumieniu, to „kolor” światła białego emitowanego przez źródło, np. źródło LED.

W uproszczeniu możemy podzielić je na światło o:

- barwie ciepłej
- barwie neutralnej
- barwie zimnej

Colour temperature (K) in common understanding is the colour of white light emitted by a source, for example such as an LED source.

In simple terms, we can divide them into:

- Warm white
- White
- Cool white

2700-3300K

Barwa ciepła
Warm white

3400-5300K

Barwa neutralna
White

5400-7000K

Barwa zimna
Cool white

Strumień świetlny (lm/lumen) - w potocznym rozumieniu, to całkowita moc światła emitowanego z danego źródła światła.

Lumen (lm) - jednostka miary strumienia świetlnego w układzie SI

1 lm = 1 cd·sr

Luminous flux (lm / lumen) - the total power of light emitted from a light source.

Lumen (symbol: lm) - the unit of luminous flux in SI system.

1 lm = 1 cd·sr

Natężenie oświetlenia (lx/luks) - w potocznym rozumieniu, to gęstość strumienia świetlnego padającego na daną powierzchnię.

Luks (lx) - jednostka natężenia oświetlenia w układzie SI.

1 lx = 1 cd·sr / m²

Illuminance (lx / lux) - in common understanding, it is the density of the luminous flux incident on a given surface.

Lux (lx) - a unit of illuminance in the SI system.

1 lx = 1 cd sr / m²

CRI (od ang. colour rendering index), Ra - wskaźnik oddawania barw charakteryzujący źródło światła, który określa, jak dobrze postrzegane są barwy oświetlonych przedmiotów.

Im wskaźnik ten jest wyższy, tym barwy są lepiej oddawane, a oświetlane przedmioty wyglądają naturalniej.

Wyrażony jest liczbą z przedziału od 0 do 100, gdzie 100 to światło słoneczne.

Minimum wg przepisów w UE dla opraw wewnętrznych to 80.

CRI- is an index of a light source's ability to reveal colours. It determines how well illuminated colours are perceived.

The higher index, the better colour rendering and the illuminated objects look more natural.

It is expressed with a number from 0 to 100, where 100 is a sunlight.

The minimum according to EU regulations for indoor luminaires is 80.

Stopień ochrony IP / Degree of protection IP

Stopień ochrony jest wyrażony dwoma cyframi. Pierwsza oznacza ochronę przed ciałami stałymi. Druga to ochrona przed cieczami.

Degree of protection is expressed by two figures. The first one stands for protection against solid particles. The second one stands for protection against liquids.

1 cyfra / 1st figure	
IP0...	Brak ochrony / Not protected
IP1...	Ochrona przed ciałami stałymi większymi niż 50 mm / Protected against solid objects greater than 50 mm
IP2...	Ochrona przed ciałami stałymi większymi niż 12 mm / Protected against solid objects greater than 12 mm
IP3...	Ochrona przed ciałami stałymi większymi niż 2,5 mm / Protected against solid objects greater than 2,5 mm
IP4...	Ochrona przed ciałami stałymi większymi niż 1 mm / Protected against solid objects greater than 1 mm
IP5...	Ochrona przed pyłem / Protected against dust infiltration
IP6...	Ochrona pyłoszczelna / Totally protected against dust infiltration

2 cyfra / 2nd figure	
IP...0	Brak ochrony / Not protected
IP...1	Ochrona przed padającymi kroplami wody / Protected against vertically falling water drops
IP...2	Ochrona przed padającymi kroplami wody przy wychyleniu do 15° / Protected against falling water drops up to 15° from the vertica
IP...3	Ochrona przed natryskiwana wodą / Protected against rain
IP...4	Ochrona przed bryzgami wody / Protected against splashing water
IP...5	Ochrona przed strugami wody / Protected against water jets
IP...6	Ochrona przed falami / Protected against powered water jets
IP...7	Ochrona przed zanurzeniem / Protected against temporary immersion
IP...8	Ochrona przed głębokim zanurzeniem / Protected against continuous immersion

IKONY / ICONS





 Oprawy oznaczone tym symbolem nie wolno okrywać materiałem termoizolacyjnym.
Fittings marked with this symbol must not be covered with thermal insulation materials.

 Klasa ochronna druga oznacza, że oprawa posiada podwójną izolację ochronną, a przewód ochronny (żyła żółto-zielona) nie może być podłączony do oprawy oświetleniowej.
Protection class II means that the fittings are equipped with a double protective insulation, and the green and yellow protective conductor must not be connected to the fitting.

 Klasa ochronna pierwsza oznacza, że oprawa musi być podłączona za pomocą przewodu ochronnego (żyła żółto-zielona) do przewodu lub zacisku uziemiającego.
Protection class I means that the fitting must be connected with the yellow and green protective conductor to the grounding wire or terminal.

 Klasa ochronna III oznacza, bezpieczeństwo elektryczne gwarantowane przez bardzo niskie zasilanie (poniżej 50 V). Bez uziemienia.
Protection class III means, that electrical safety is guaranteed by a very low power supply (less than 50 Volt). No grounding.

 Oprawy oznaczone tym symbolem wolno instalować wyłącznie na podłożach niepalnych.
Fittings marked with this symbol are suitable for installation only on nonflammable surfaces.

 Zgodność produktów z ukraińskimi normami.
Ukrainian standards compliant.

 Zgodność z normami Unii Europejskiej.
EU standards compliant.

 Zgodność produktów z normami Euroazjatyckiej Unii Gospodarczej.
EAEU standards compliant.

 Do użytku zewnętrznego.
Exterior use only.













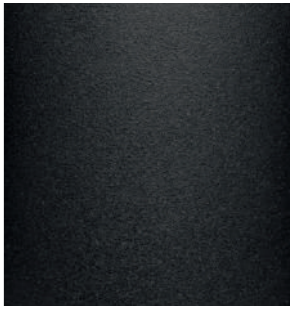
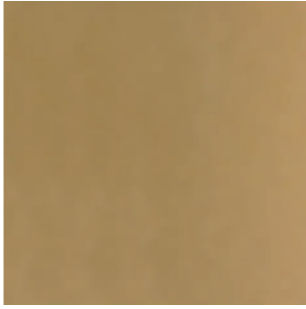

 Do wewnętrznego użytku.
Interior use only.

 Do stosowania wewnątrz i na zewnątrz.
Interior and exterior use.

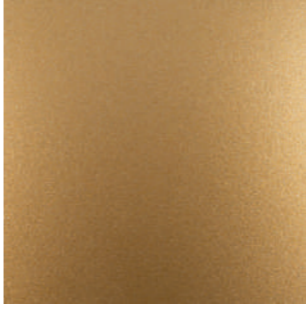
 Zużyte oprawy oświetleniowe są surowcami wtórnymi - nie wolno wyrzucać ich do pojemników na odpady domowe, mogą zawierać substancje niebezpieczne dla zdrowia i życia ludzkiego oraz środowiska. Zgodnie z dyrektywą WEEE 2012/19/UE użytkownik zobowiązany jest do oddania opraw do punktu zbierania zużytego sprzętu, co przyczyni się do ochrony środowiska naturalnego.
Used lighting fixtures are recyclable materials - they must not be disposed of in household waste containers as they may contain substances hazardous to human health or life as well as to the natural environment. In accordance with Regulation WEEE 2012/19 /EU, luminaire user is obliged to return a used lighting fixture to a waste appliance collection point, which will contribute to the protection of the natural environment.

Material	Materiał
Acrylic crystals	Kryształki akrylowe
Aluminum	Aluminium
Braided cable	Przewód w oplocie
Brass plated steel	Stal mosiądzowana
Brushed stainless steel	Stal nierdzewna szczotkowana
Ceramic housing	Ceramiczna oprawka
Chrome	Chrom
Chrome plated steel	Stal chromowana
Composite	Kompozyt
Concrete	Beton architektoniczny
Copper plated steel	Stal miedziana
Crystal	Kryształ
Fabric	Tkanina
Flexible stem	Peszel
Glass	Szkło
Gypsum	Gips
Metallized glass	Szkło metalizowane
Painted aluminum	Aluminium lakierowane
Painted steel	Stal lakierowana
Plastic	Tworzywo sztuczne
Plastic ABS	Tworzywo sztuczne ABS
Plastic PA	Tworzywo sztuczne PA
Plastic PC	Tworzywo sztuczne PC
Plastic PP	Tworzywo sztuczne PP
Plastic PS	Tworzywo sztuczne PS
Plastic PC/ABS	Tworzywo sztuczne PC/ABS
Plastic PE	Tworzywo sztuczne PE
Plastic PMMA	Tworzywo sztuczne PMMA
Plywood	Sklejka
Rubber cable	Przewód gumowy
Silicone	Silikon
Solid brass	Lity mosiądz
Steel	Stal
Velvet	Aksamit
Wood	Drewno

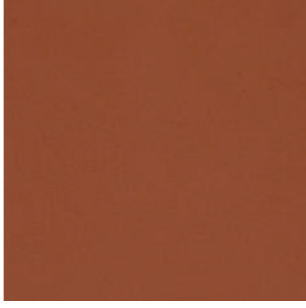
KODY KOLORÓW / COLOUR CODES

			
P001 / RAL 9003	P003 / RAL 9003	P004 / RAL 9003	P005
			
P010 / RAL 7016	P013 / RAL 9005	P014 / RAL 9005	P015
			
P018	P020	P021	P022
			
P023	P024	P025	P026 / RAL 7044
			
P027 / RAL 7022	P028	P029	P030

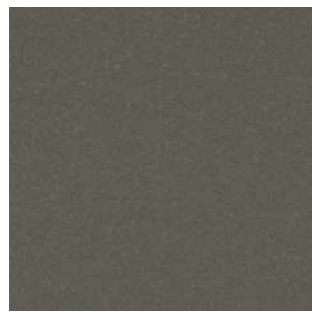

P031



P032



P033



P034



P035



T003



T004



T005

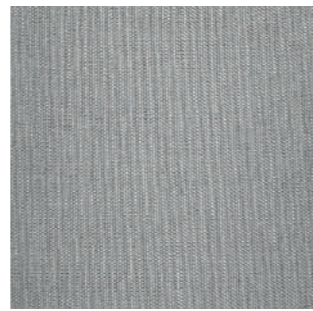

T008

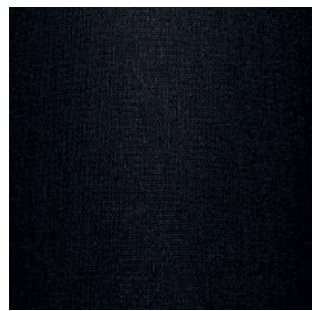

T011

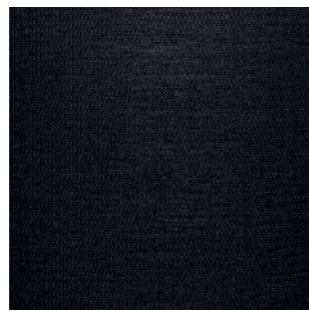

T012

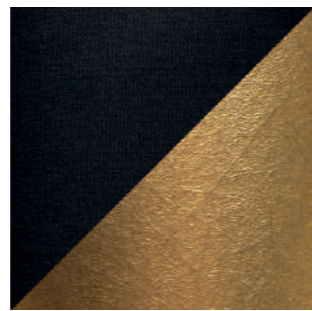

T013



T022



T023



T024



T025



T026

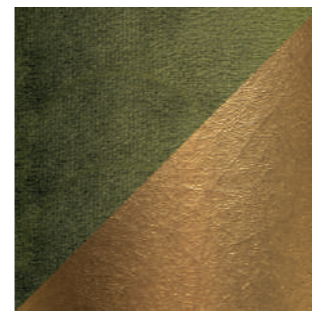

T029



T032

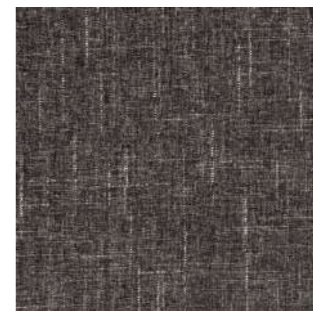

T033

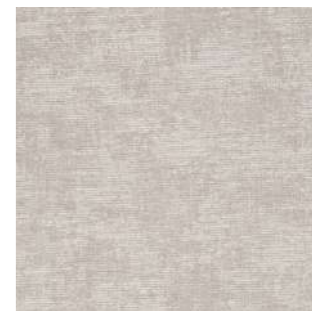

T034



T035



T036



T037

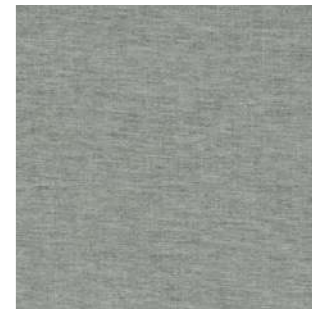

T038



T039

ALFABETYCZNY SPIS TREŚCI / ALPHABETICAL INDEX

A	
ABBY LED.....	561
ABI L.....	243
ACRE.....	487
ACROBAT.....	589
AGAVE.....	467
AGNES ROUND LED PRO.....	492
AGNES SQUARE LED PRO.....	493
ALICE.....	190
ALICE L.....	190, 191
ALOE.....	466
ALPHA.....	481
AMALFI.....	143
AMALFI L.....	143
AMALFI M.....	143
AMARELA.....	157
AMARELA A.....	156
AMARELA B.....	156
AMARELA L.....	155
AMARELA M.....	154, 155
AMARELA S.....	154
AMELIA.....	571
AMUR.....	572
AMY LED.....	552
ANA.....	570
ARALIA.....	467
ARENA.....	316
ARENA LED.....	316
ARENA SENSOR.....	316
ARES.....	296
ARIA LED L.....	535
ARIA LED M.....	535
ARIA LED S.....	535
ARIA LED XL.....	535
ARM LED L.....	48
ARM LED M.....	48
ARRIS.....	541
ASSAM.....	564
ASSOS.....	540
AVA LED.....	561
B	
BAHIA.....	487
BALLERINA.....	589
BAR LED L.....	41
BAR LED M.....	41
BAR LED S.....	40
BASALT.....	564
BATON.....	99
BAY LED.....	562
BERGEN.....	269
BIT S.....	339
BOHO L.....	235
BOHO M.....	235
BOHO S.....	235
BOL.....	481
BRAVO.....	480
BRAZOS.....	472, 473
BRICK.....	547
BULB LED E27, A60, 10W.....	585
BULB LED E27, A60, 7W.....	585
BULB GLASS BALL LED, E27, 8W.....	582
BULB LED E14, C35, 6W.....	585
BULB LED E14, T25, 4W.....	582
BULB LED E27, A60 2W, 5 PC SET.....	585
BULB LED G9, 4W.....	580
BULB LED G9, 7W.....	580
BULB LED GX53, 8W.....	582
BULB LENS LED, G9, 3W.....	580
BULB VINTAGE LED E27, 6W.....	584
BUSH.....	566
C	
CABO LED.....	547
CADILAC.....	180, 181
CAMELEON ADAPTER CTLS.....	435
CAMELEON ADAPTER PROFILE.....	455
CAMERON.....	184, 185
CANOE.....	294
CAYO.....	475
CEARA.....	478
CEDRO.....	163
CEDRO A.....	162
CEDRO B.....	162
CEDRO L.....	160, 161
CEDRO M.....	160, 161
CEDRO S.....	160, 161
CERAMIC LED.....	138, 139
CEZANNE LED L.....	491
CEZANNE LED M.....	491
CEZANNE LED S.....	491
CHARLIE.....	484
CHILLIN.....	198
CIRCLET LED.....	569
CIRCOLO LED.....	25, 26, 27
CIRCOLO LED M.....	24, 29, 32
CIRCOLO LED S.....	24, 29, 32
CIRCOLO LED XS.....	29
CIRCOLO POWER LED.....	25, 26
CL DIA LED 18W.....	348
CL DIA LED 30W.....	348
CL IOS LED 20W, ANGLE 36.....	332
CL IOS LED 20W, ANGLE 60.....	332

CL IOS LED 30W, ANGLE 36.....	333
CL IOS LED 30W, ANGLE 60.....	333
CL IOS LED 40W, ANGLE 60.....	333
CL KEA LED 20W.....	349
CL KEA LED 40W.....	349
CL KOS LED 10W.....	346
CL KOS LED 16W.....	346
CL KOS LED 24W.....	346
CL KOS LED 8W.....	346
CL OFFICE LED PRO 120.....	306
CL OFFICE LED PRO 150.....	307
CL OFFICE PRO/HALL PRO POWER SUPPLY KIT.....	306, 307
CL OFFICE PRO/HALL PRO SUSPENSION KIT.....	306, 307
CLAY M.....	141
CLAY S.....	141
CLINE LED.....	560
COBBLE.....	322
COMMA LED L.....	275
COMMA LED M.....	275
COMMA LED S.....	275
CRAFT.....	287
CRATE.....	282
CRES.....	340
CRISTAL.....	133
CRISTAL L.....	133
CRISTAL M.....	132
CTLS DEAD END CAP.....	439
CTLS MILO LED 15W.....	426
CTLS MILO LED 25W.....	427
CTLS MONO.....	435
CTLS NEA LED 20W.....	428
CTLS NEA LED 30W.....	429
CTLS NEA LED 40W.....	430
CTLS POWER END CAP, LEFT (PE-L).....	438
CTLS POWER END CAP, RIGHT (PE-R).....	438
CTLS POWER FLEX CONNECTOR.....	439
CTLS POWER L CONNECTOR, LEFT (L-L).....	438
CTLS POWER L CONNECTOR, RIGHT (L-R).....	438
CTLS POWER STRAIGHT CONNECTOR.....	438
CTLS POWER SUPPLY KIT 3 CIRCUIT.....	437
CTLS POWER T CONNECTOR, LEFT 1 (T-L1).....	439
CTLS POWER T CONNECTOR, LEFT 2 (T-L2).....	439
CTLS POWER T CONNECTOR, RIGHT 1 (T-R1).....	439
CTLS POWER T CONNECTOR, RIGHT 2 (T-R2).....	439
CTLS POWER X CONNECTOR.....	439
CTLS RECESSED DEAD END CAP.....	443
CTLS RECESSED FIXING SET.....	443
CTLS RECESSED POWER END CAP, LEFT (PE-L).....	442
CTLS RECESSED POWER END CAP, RIGHT (PE-R).....	442
CTLS RECESSED POWER FLEX CONNECTOR.....	443
CTLS RECESSED POWER L CONNECTOR, LEFT (L-L).....	442
CTLS RECESSED POWER L CONNECTOR, RIGHT (L-R).....	442
CTLS RECESSED POWER STRAIGHT CONNECTOR.....	442
CTLS RECESSED POWER T CONNECTOR, LEFT 1 (T-L1).....	443
CTLS RECESSED POWER T CONNECTOR, LEFT 2 (T-L2).....	443
CTLS RECESSED POWER T CONNECTOR, RIGHT 1 (T-R1).....	443
CTLS RECESSED POWER T CONNECTOR, RIGHT 2 (T-R2).....	443
CTLS RECESSED POWER X CONNECTOR.....	443
CTLS RECESSED TRACK 3 CIRCUIT 1M.....	440
CTLS RECESSED TRACK 3 CIRCUIT 2M.....	440
CTLS SNOWBALL.....	434
CTLS STRAIGHT CONNECTOR MINI.....	439
CTLS SUSPENSION KIT 3 CIRCUIT.....	437
CTLS TINOS LED 10W.....	432
CTLS TINOS LED 20W.....	432
CTLS TINOS LED 30W.....	433
CTLS TRACK 3 CIRCUIT 1M.....	436
CTLS TRACK 3 CIRCUIT 2M.....	436
CUMULUS CUBE L.....	502
CUMULUS CUBE M.....	502
CUMULUS L.....	498, 499
CUMULUS M.....	498, 499
CUMULUS S.....	498, 499
CUMULUS XL.....	498
CUP.....	343
CUP 3 PC SET.....	343
CYLINDER L.....	100
CYLINDER M.....	100
D	
DELTA.....	484
DEMI LED L.....	533
DEMI LED M.....	533
DISK.....	218
DON.....	573
DOT.....	353
DOVER.....	226, 227
DOWNLIGHT ES111.....	351
DROPS WOOD A.....	205
DROPS WOOD B.....	205
DROPS WOOD C.....	202
DROPS WOOD D.....	202
DROPS WOOD E.....	203
DROPS WOOD F.....	203
E	
EASY LED LEFT.....	46
EASY LED RIGHT.....	46
ECHO.....	485
EDESA LED M.....	545
EDESA LED S.....	545
EGG L.....	295
EGG M.....	295
EGG XL.....	295

EGINA LED 10W	345
EGINA LED 15W	345
EGINA LED 5W	345
ELLIPSES LED	536
EXE	543
EYE	97, 102
EYE FLEX	103
EYE FLEX S	103
EYE L	96, 98, 101
EYE M	96, 101
EYE MOD	352
EYE S	101
EYE SPOT	104, 105
EYE SUPER	106-109
EYE SUPER A	107
EYE SUPER B	107
EYE TONE	337, 338
EYE WALL	102
EYE WALL CUT	102

F

FALCON	189
FESTOON LIGHTS 6m	577
FESTOON LIGHTS 9m	577
FLEA	335
FLOWERPOT L	500
FLOWERPOT M	500
FLOWERPOT S	500
FOCUS MINI LED	330
FOG	542
FORM L	183
FORM M	183
FOURTY	70, 71, 74, 76, 77
FOURTY L	72
FOURTY M	72, 73
FOURTY S	72, 73
FOURTY SURFACE	76
FOURTY WALL M	74
FOURTY WALL S	74
FOURTY WALL XL	75
FOURTY XL	72
FOXTROT	482

G

GAP	322
GARRET	289
GARRET M	289
GARRET S	289
GIAVELLOTTO LED L	37
GIAVELLOTTO LED M	37
GIAVELLOTTO LED S	37

GIOTTO LED M	297
GIOTTO LED S	297
GLOBE PLUS	123
GLOBE PLUS M	123
GLOBE PLUS S	123
GOLF	485
GROOVE	322, 323

H

HAGA	269
HAITI L	234
HAITI M	234
HAITI S	234
HALO	334
HAMPTON	134
HANGING SET FOR PICNIC LED	550
HARMONY	284
HAVANA L	232, 233
HAVANA M	232, 233
HAVANA S	232, 233
HEFT	219
HELIOS LED	486
HEMISPHERE HIT L	292
HEMISPHERE HIT S	292
HEMISPHERE RUST L	290
HEMISPHERE RUST S	290
HEMISPHERE SUPER L	291, 293
HEMISPHERE SUPER S	291, 293
HERMANOS	261
HERMANOS A	260
HERMANOS B	260
HERMANOS C	260
HEXA	545
HIGH-BAY	288
HONEY COMB	589
HORN	522
HOTEL MOOD	192, 194
HOTEL MOOD LED	192
HOTEL PLUS	196
HVAR	341

I

ICE BALL	466
ICE EGG A	474
ICE EGG C	474
ICE TUBE LED M	470, 471
ICE TUBE LED S	470, 471
IDA	511
IKA A	223
IKA D	223
IMBRIA	112

IMPULSE LED L	52
IMPULSE LED M	52
IMPULSE LED S	53
INA	564
INDIA	335
ION LED L	305
ION LED M	305
IRIS LED	299
ISLA LED	532

J

JAPANDI M	236
JAPANDI S	236
JULIET	486

K

KARO	116, 117
KASAI	317
KHUMBU	549
KIER L	121
KIER M	121
KIER S	121
KRABI	237
KYMI A	222
KYMI B	222
KYMI C	222

L

LAGO	169
LAGO A	168
LAGO B	168
LAGO L	166, 167
LAGO M	166, 167
LAGO S	166, 167
LAGUNA	179
LANTERN	573
LASER 1000	61, 62, 63
LASER 490	60, 62, 63
LASER 750	62, 63, 64
LASER 900	64
LASER WALL	67
LASER WALL L	66
LATH LED	489
LENS LED	539
LHOTSE LED	513
LIA LED	299
LID ROUND LED 15W	313
LID ROUND LED 25W	313
LID ROUND LED 35W	313
LID ROUND LED 50W	313

LID SQUARE LED 15W	314
LID SQUARE LED 25W	314
LID SQUARE LED 35W	314
LID SQUARE LED 50W	314
LINEO LED	34
LIV LED	509
LUKSOR S	243
LUSSO	199
LUXORA LED	130, 131
LVM 48V, 150W, INSIDE POWER SUPPLY	418, 422
LVM CORNER CONDUCTIV	422
LVM CORNER CONDUCTIVE MODULE	419
LVM FOCUS LED 15W	400
LVM FOCUS LED 9W	401
LVM FOCUS OUT LED 15W	402
LVM FOCUS OUT LED 9W	403
LVM HORIZONTAL CORNER	419
LVM INSIDE CORNER	419
LVM LID LED 8W	410
LVM LINE LED 15W	404
LVM LINE LED 9W	405
LVM OUTSIDE POWER SUPPLY CONDUCTIVE MODULE	419, 422
LVM POWER SUPPLY KIT	417
LVM RECESSED HORIZONTAL CORNER	423
LVM RECESSED INSIDE CORNER	423
LVM RECESSED TRACK 1M	420
LVM RECESSED TRACK 2M	420
LVM ROLLER LED 9W	408
LVM SLOT LED 5W	411
LVM SLOT LED 8W	411
LVM SPOT LED 15W	406
LVM SPOT LED 9W	407
LVM STRAIGHT CONDUCTIVE MODULE	419, 422
LVM SUSPENSION KIT	417
LVM TRACK 1M	416
LVM TRACK 2M	416
LVM TRACK BUCKLE CONNECTOR	419, 422

M

MAHE LED	555
MALAKKA LED	477
MALMO	269
MARGOT	538
MAUN	481
MEKONG	526
MERIDA LED	556
MIA LED L	510
MIA LED M	510
MICROWAVE SENSOR	587
MIDI LED	324, 325
MIDI LED RECESSED	326
MINI LED RECESSED	329

MINIMAL.....	228	NANO - LVM RECESSED HORIZONTAL CORNER.....	378
MIST.....	182	NANO - LVM RECESSED INSIDE CORNER.....	378
MISTRAL.....	527	NANO - LVM RECESSED OUTSIDE POWER SUPPLY CONDUCTIVE	
MLJET.....	340	MODULE FOR SUSPENSION TRACK.....	373
MOD.....	350	NANO - LVM RECESSED TRACK 1M.....	376
MOD PLUS.....	350	NANO - LVM RECESSED TRACK 2M.....	376
MON LED.....	569	NANO - LVM SPOT LED 1W.....	366
MONACO.....	144, 145	NANO - LVM SPOT ZOOM LED 15W.....	369
MONO.....	82, 83, 86, 89, 94, 95	NANO - LVM SPOT ZOOM LED 2W.....	368
MONO 2x150.....	86	NANO - LVM SPOT ZOOM LED 5W.....	368
MONO 2x200.....	86	NANO - LVM SPOT ZOOM LED 7W.....	369
MONO CORNER 2x150.....	87	NANO - LVM STRAIGHT CONDUCTIVE MODULE.....	375, 378
MONO CORNER 2x200.....	87	NANO - LVM SUSPENSION KIT.....	373
MONO DEEP.....	92	NANO - LVM TRACK 1M.....	372
MONO LONG.....	88	NANO - LVM TRACK 2M.....	372
MONO LONG M.....	88	NANO - LVM TRACK BUCKLE CONNECTOR.....	375, 379
MONO S.....	81	NATALIE.....	469
MONO SLIDE.....	93	NEGRO.....	543
MONO SLIDE TRIMLESS.....	93	NEL LED.....	530
MONO SURFACE.....	90, 91	NESS.....	242
MONTERREY LED.....	516	NEWPORT.....	135
MORE EYE.....	110	NICO.....	541
MORE TONE.....	111	NIKKI ROUND LED.....	310
MOSS.....	197	NOOK.....	574
MOTIVE LED L.....	42	NORIN.....	522
MOTIVE LED M.....	42		
MULTI LED.....	308	O	
MUNO LED.....	549	OIA LED.....	565
MURTER.....	340	OIR.....	525
MYKONOS LED 10W.....	344	ORBIT.....	263, 264, 265
MYKONOS LED 15W.....	344	ORGANIC.....	298
MYKONOS LED 18W.....	344	ORINOKO.....	546
MYKONOS LED 24W.....	344	ORLA LED M.....	531
MYKONOS LED 6W.....	344	ORLA LED S.....	531
		ORTO.....	58
N		ORTO A.....	59
NALA LED.....	554	ORTO B.....	59
NANO - LVM CORNER CONDUCTIVE MODULE.....	375, 378	OSCAR.....	548
NANO - LVM CURVE TRACK R460.....	372	OSLO 30.....	228
NANO - LVM FLEX LINE LED 6W.....	365	OSLO LED 90.....	229
NANO - LVM FOCUS OUT LED 10W.....	360	OTTAWA.....	520
NANO - LVM FOCUS OUT LED 5W.....	361	OUTLINE LED L.....	558
NANO - LVM HORIZONTAL CORNER.....	375	OUTLINE LED M.....	558
NANO - LVM INSIDE CORNER.....	375	OUTLINE LED S.....	558
NANO - LVM LINE IN LED 6W.....	364	OVAL.....	323
NANO - LVM LINE OUT LED 10W.....	363		
NANO - LVM LINE OUT LED 20W.....	362	P	
NANO - LVM MUG LED 7W.....	367	PAG.....	322
NANO - LVM OUTSIDE POWER SUPPLY CONDUCTIVE MODU-		PALMAS LED.....	479
LE.....	375, 378	PAN LED M.....	477
NANO - LVM OUTSIDE POWER SUPPLY CONDUCTIVE MODULE		PAN LED S.....	477
FOR SUSPENSION TRACK.....	373		

PANTOGRAPH.....	286	PROFILE IRIS LED 12W.....	448
PAOLI.....	569	PROFILE IRIS LED 20W.....	449
PARANA.....	480	PROFILE IRIS LED 7W.....	448
PAT LED.....	569	PROFILE L CONNECTOR.....	459
PATHWAY FOUNDATION KIT.....	528	PROFILE MIKE.....	450
PATHWAY LED L.....	529	PROFILE MONO.....	454
PATHWAY LED M.....	529	PROFILE POWER END CAP.....	458
PATHWAY LED PRO.....	528	PROFILE POWER STRAIGHT CONNECTOR.....	458
PATHWAY LED S.....	529	PROFILE POWER SUPPLY KIT.....	457
PATIO.....	503	PROFILE PUCK.....	454
PEAR.....	127	PROFILE RECESSED DEAD END CAP.....	463
PEAR L.....	126	PROFILE RECESSED FIXING SET.....	463
PEAR M.....	126	PROFILE RECESSED FLEX CONNECTOR.....	463
PEAR S.....	126	PROFILE RECESSED L CONNECTOR.....	463
PICASSO LED.....	489	PROFILE RECESSED POWER END CAP.....	462
PICCO LED L.....	568	PROFILE RECESSED POWER STRAIGHT CONNECTOR.....	462
PICCO LED M.....	568	PROFILE RECESSED STRAIGHT CONNECTOR.....	463
PICCO LED S.....	568	PROFILE RECESSED T CONNECTOR.....	463
PICNIC LED.....	550	PROFILE RECESSED TRACK 1 METER.....	460
PIK.....	122	PROFILE RECESSED TRACK 2 METERS.....	460
PILLS.....	266, 267	PROFILE RECESSED X CONNECTOR.....	463
PIN LED L.....	488	PROFILE SNOWBALL.....	452, 455
PIN LED M.....	488	PROFILE STRAIGHT CONNECTOR.....	459
PIN LED S.....	488	PROFILE SUSPENSION KIT.....	457
PIX LED.....	557	PROFILE T CONNECTOR.....	459
PLANT.....	283	PROFILE TINOS LED 10W.....	446
POINT DUO.....	248	PROFILE TINOS LED 20W.....	447
POINT PLEXI L.....	339	PROFILE TINOS LED 30W.....	447
POINT PLEXI M.....	339	PROFILE TINOS LED 7W.....	446
POINT S.....	339	PROFILE TRACK 1 M.....	456
POINT TONE.....	334	PROFILE TRACK 2 M.....	456
POISE A.....	172	PROFILE VESPA.....	455
POISE B.....	172	PROFILE X CONNECTOR.....	459
POLARIS.....	142	PROFILE ZOOM LED.....	451
POLE LED.....	518	PUEBLA LED.....	556
POWER CORD FOR FESTOON LIGHTS.....	577	PUKET L.....	231
POWER SUPPLY COVER.....	375	PUKET M.....	231
POWER SUPPLY, 24V DC, 150W.....	588	PUKET S.....	231
POWER SUPPLY, 24V DC, 75W.....	588	PUMPKIN L.....	241
POWER SUPPLY, 48V DC, 200W.....	588	PUMPKIN M.....	241
POWER SUPPLY, 48V DC, 320W.....	588	PUMPKIN S.....	240
POWER SUPPLY, 48V DC, 80W.....	588		
PRIMM.....	540	Q	
PROFILE BIT.....	453	QUARTZ.....	546
PROFILE BIT PLUS.....	453		
PROFILE DEAD END CAP.....	459	R	
PROFILE EYE.....	453	RADIUS.....	276
PROFILE EYE SPOT.....	454	RATTAN L.....	230
PROFILE EYE SUPER A.....	452	RATTAN M.....	230
PROFILE EYE SUPER C.....	452	RATTAN S.....	230
PROFILE FLEX CONNECTOR.....	459	REFLECTOR DIFFUSER LED, GU10, ES111, 9W.....	583
PROFILE FOCUS LED.....	450		
PROFILE INDIA.....	450		

REFLECTOR LED, GU10, R35, 4W	581
REFLECTOR LED, GU10, R50, 7W	581
REFLECTOR LED, GU10, R50, 7W, DIMMABLE	581
REFLECTOR LENS LED, GU10, ES111, 9W	583
RING LED L	272, 273
RING LED M	272, 273
RING LED S	272, 273
RING MIRROR LED L	271
RING MIRROR LED M	271
RING MIRROR LED S	271
RING TIMBER LED L	212
RING TIMBER LED M	212
RING TIMBER LED S	212
RING TIMBER LED XL	212
RING TIMBER LED XXL	212
RING WOOD LED L	216
RING WOOD LED M	216
RING WOOD LED S	216
RIO	524
RIO SENSOR	524, 525
ROCK PRO	544
RUBY LED	508
RUMI LED	567

S

SABER LED L	45
SABER LED M	44
SANTANA	153
SANTANA L	151
SANTANA M	150, 151
SANTANA A	152
SANTANA B	152
SANTANA S	150
SATELLITE L	259
SATELLITE M	258, 259
SATELLITE S	258, 259
SATELLITE S SENSOR	259
SEMI LED	537
SEMI LED M	537
SET	336, 585
SHINE	341
SIDEWALK ROUND LED	563
SIDEWALK SQUARE LED	563
SIERRA	544
SILBA	340
SILICONE	279
SIMI	473
SIMONE	246
SIS	475
SLASH LED	49
SLIM LED	513
SLING	113

SLIT LED	512
SMART LED	319
SNOWBALL	120
SOFT CEILING LED 120X6	304
SOFT CEILING LED 60X20	304
SOFT CEILING LED 60X6	304
SOFT CEILING LED 60X60	304
SOFT CEILING LED 90X20	304
SOFT CEILING LED 90X6	304
SOFT LED 120X6	303
SOFT LED 90X6	303
SOFT WALL LED 60X6	302
SOFT WALL LED 90X6	302
SOLTA	341
SOUL	521
SPHERE	125
SPHERE L	124
SPHERE M	124
SPHERE S	124
SPHERE XL	124
SPIDER	280
SPIKE LED M	566
SPIKE LED S	566
SPIN LED L	51
SPIN LED M	51
SPIN LED S	51
STALACTITE	65
STAR	503
STEP LED	565
STONE L	496
STONE M	496
STONE S	496
STRAIGHT CEILING LED S	300
STRAIGHT CEILING LED L	300
STRAIGHT CEILING LED M	300
STRAIGHT WALL LED L	301
STRAIGHT WALL LED M	301
STRAIGHT WALL LED S	301
STRAIGHT WALL XS	301
STRUCTURE LED	514
SUN LED	211
SUNRISE LED	210
SUNSET	211
SUNSET A	208
SUNSET B	208
SUNSET C	208
SUNSET LED D	210
SUNSET NATURAL A	209
SUNSET NATURAL B	209
SUNSET NATURAL C	209
SYMMETRY LED	515

T

TAHOE II	575
TAHOE SENSOR	575
TAY	572
TECHNO	284, 285
TEPIC LED	516
TESSA LED	508
THIKA LED	517
THIKA LED B	517
TORCH	478
TRIANGLES LED	536
TUBE	299
TUBE LED T8, 11W	586
TUBE LED T8, 16W	586
TUBE LED T8, 22W	586
TUBINGS	523
TUBINGS M	523
TUBINGS S	523
TURDA	176, 177, 178
TUTOIA	171
TWIG	281
TYBR	573

U

UNIT LED	547
UNO L	342
UNO M	342
UNO S	342
UT-LVM 48V, 100W INSIDE POWER SUPPLY	397
UT-LVM 48V, 200W INSIDE POWER SUPPLY	397
UT-LVM END CAP	397
UT-LVM FOCUS LED 12W	383
UT-LVM FOCUS LED 18W	382
UT-LVM FOCUS OUT LED 12W	386
UT-LVM FOCUS OUT LED 6W	387
UT-LVM FOCUS SWING LED 12W	388
UT-LVM FOCUS SWING LED 6W	389
UT-LVM L CONNECTOR	397
UT-LVM LINE LED 12W	385
UT-LVM LINE LED 18W	384
UT-LVM OUTSIE POWER SUPPLY CONDUCTIVE MODULE	397
UT-LVM ROLLER LED 10W	393
UT-LVM SPOT LED 12W	392
UT-LVM SPOT LED 5W	390
UT-LVM SPOT LED 9W	391
UT-LVM STRAIGHT CONNECTOR	397
UT-LVM TRACK 1M	395
UT-LVM TRACK 2M	395
UT-LVM VERTICAL CONNECTOR	397

V

VAN GOGH LED L	54
VAN GOGH LED M	54
VAN GOGH LED S	54
VERTIC LED	35
VETRO	146, 147
VIOLET	187
VIPER	188
VIS	341
VISTA	476
VIVIANE	186

W

WATERPROOF „Y“ CONNECTOR IP68	587
WATERPROOF CONNECTOR IP68	587
WAVE S	242
WHEEL	214
WHEEL LUX	214, 215
WORKSHOP	278
WORKSHOP A	278
WORKSHOP B	278
WORKSHOP C	278

Z

ZENITH L	253, 254
ZENITH M	253, 254
ZENITH S	252, 254
ZENITH XS	252
ZOLA LED	507
ZURI LED	519

INDEKS LAMP / PROGRESSIVE CODE INDEX

INDEX	STRONA PAGE СТРАНИЦА	INDEX	STRONA PAGE СТРАНИЦА	INDEX	STRONA PAGE СТРАНИЦА	INDEX	STRONA PAGE СТРАНИЦА
203	296	4692	572	6345	301	6526	339
205	296	4694	572	6350	301	6528	339
206	296	4698	526	6367	290	6530	339
3394	527	4906	522	6368	290	6532	186
3401	566	4907	564	6390	186	6605	278
3402	542	4961	190	6391	186	6607	105
3403	542	4963	191	6403	279	6611	105
3404	542	5067	288	6404	279	6640	188
3408	547	5255	101	6442	289	6641	188
3411	546	5292	572	6443	289	6768	242
3412	564	5294	572	6444	289	6772	186
4171	223	5397	96	6481	97	6773	186
4174	223	5455	96	6487	107	6774	186
4387	546	5463	101	6488	107	6775	537
4418	526	5471	101	6490	107	6776	549
4420	526	5654	102	6491	108	6785	280
4422	544	6000	339	6492	109	6788	280
4423	524	6014	104	6493	106	6792	280
4424	524	6015	104	6501	107	6836	101
4425	543	6016	104	6502	107	6837	101
4443	549	6017	105	6503	107	6838	101
4446	522	6018	104	6504	108	6840	96
4448	513	6020	104	6505	109	6841	96
4453	564	6021	104	6506	106	6842	102
4454	569	6022	105	6512	188	6907	565
4686	573	6336	278	6513	188	6908	565
4687	573	6337	278	6525	339	6911	573

INDEKS LAMP / PROGRESSIVE CODE INDEX

INDEX	STRONA PAGE	INDEX	STRONA PAGE	INDEX	STRONA PAGE	INDEX	STRONA PAGE
6913	299	7537	303	7595	301	7638	272
6948	472	7538	304	7596	301	7640	272
6950	472	7540	304	7597	300	7641	146
6951	472	7541	302	7598	300	7642	146
6976	498	7542	304	7600	300	7644	218
6977	498	7544	304	7601	301	7645	218
6978	498	7546	304	7603	339	7646	215
7017	524	7547	303	7605	123	7647	211
7487	585	7548	302	7606	123	7651	211
7500	586	7551	300	7607	123	7652	210
7501	586	7552	300	7614	133	7653	208
7502	586	7553	300	7616	132	7654	208
7503	580	7556	300	7618	450	7655	208
7504	580	7557	300	7620	450	7657	450
7520	229	7558	300	7621	450	7661	450
7522	229	7560	301	7622	450	7663	486
7524	304	7561	301	7623	451	7664	486
7525	303	7562	301	7624	451	7665	338
7526	304	7566	301	7625	451	7666	338
7527	304	7567	301	7626	451	7667	61
7528	302	7568	301	7627	132	7668	61
7530	304	7581	454	7630	133	7671	88
7531	304	7582	454	7633	133	7672	88
7533	304	7583	454	7634	272	7674	88
7534	302	7584	454	7635	272	7675	88
7535	303	7585	454	7636	272	7683	90
7536	304	7594	301	7637	272	7688	90

INDEKS LAMP / PROGRESSIVE CODE INDEX

INDEX	STRONA PAGE	INDEX	STRONA PAGE	INDEX	STRONA PAGE	INDEX	STRONA PAGE
7694	86	7725	88	7784	83	7822	110
7695	87	7726	88	7785	86	7825	110
7696	86	7728	88	7786	89	7827	90
7697	87	7730	88	7787	89	7828	90
7698	86	7750	86	7788	125	7830	91
7700	87	7751	87	7790	322	7831	91
7701	86	7752	86	7791	322	7832	91
7702	87	7753	87	7792	322	7833	90
7703	95	7754	86	7793	322	7834	90
7704	95	7755	87	7794	127	7835	91
7705	94	7762	276	7797	126	7836	91
7706	95	7763	82	7798	126	7837	91
7707	95	7764	89	7800	126	7838	82
7708	94	7766	82	7801	265	7840	89
7710	95	7767	83	7802	264	7841	82
7711	95	7768	83	7803	264	7842	83
7712	94	7770	86	7804	265	7843	83
7713	95	7771	82	7805	264	7844	86
7714	95	7772	89	7806	264	7846	124
7715	94	7774	82	7807	82	7847	124
7716	95	7775	83	7808	89	7848	124
7717	95	7776	83	7810	82	7850	124
7718	94	7777	86	7811	83	7851	99
7720	86	7778	82	7812	83	7852	99
7721	87	7780	89	7813	86	7855	99
7722	86	7782	82	7814	111	7856	99
7723	87	7783	83	7817	111	7858	335

INDEKS LAMP / PROGRESSIVE CODE INDEX

INDEX	STRONA PAGE	INDEX	STRONA PAGE	INDEX	STRONA PAGE	INDEX	STRONA PAGE
7860	335	7976	574	8022	259	8103	260
7862	97	7978	574	8023	259	8105	260
7863	97	7988	180	8024	259	8106	550
7864	100	7991	181	8030	261	8107	550
7865	100	7993	102	8032	261	8115	53
7867	100	7994	102	8047	67	8116	52
7868	100	7995	102	8048	67	8117	52
7871	577	7996	254	8050	476	8118	471
7872	577	7997	254	8051	476	8120	471
7873	577	7998	254	8052	473	8121	470
7926	294	8001	254	8054	475	8122	470
7927	294	8002	254	8055	475	8123	478
7931	276	8003	254	8056	473	8124	474
7932	276	8005	254	8057	473	8126	466
7938	264	8006	254	8072	102	8127	488
7941	263	8007	254	8073	102	8128	488
7942	263	8010	259	8074	102	8130	488
7943	264	8011	259	8084	439	8131	489
7945	263	8012	259	8085	439	8132	474
7946	263	8013	259	8086	338	8140	536
7950	189	8014	259	8087	338	8141	536
7951	189	8015	259	8088	338	8142	536
7952	317	8016	259	8091	338	8143	536
7958	187	8017	259	8092	338	8145	514
7960	187	8018	259	8093	338	8146	514
7961	187	8020	259	8100	260	8147	563
7972	574	8021	259	8102	260	8148	563

INDEKS LAMP / PROGRESSIVE CODE INDEX

INDEX	STRONA PAGE	INDEX	STRONA PAGE	INDEX	STRONA PAGE	INDEX	STRONA PAGE
8154	134	8195	334	8243	439	8305	298
8155	134	8196	334	8244	439	8306	443
8156	135	8197	198	8245	443	8308	67
8157	135	8201	198	8246	443	8330	543
8158	523	8202	335	8247	443	8331	543
8160	523	8203	335	8248	443	8347	581
8161	523	8213	198	8250	306	8348	581
8162	569	8216	198	8250	307	8351	65
8163	569	8221	334	8262	267	8352	65
8164	562	8222	334	8263	267	8355	65
8165	562	8223	334	8264	266	8358	319
8168	297	8224	334	8265	266	8360	455
8170	297	8225	334	8266	266	8361	455
8171	305	8227	438	8267	267	8362	481
8172	305	8228	438	8268	267	8363	481
8173	477	8230	442	8270	266	8364	480
8174	477	8231	442	8281	435	8365	480
8175	489	8232	438	8282	435	8366	484
8176	515	8233	438	8283	437	8367	484
8177	550	8234	442	8284	437	8368	484
8178	550	8235	442	8288	306	8370	484
8180	515	8236	439	8288	307	8371	485
8182	536	8237	439	8290	306	8372	485
8190	180	8238	443	8291	306	8373	482
8191	181	8240	443	8302	298	8374	482
8192	260	8241	439	8303	298	8375	485
8194	260	8242	439	8304	298	8376	485

INDEKS LAMP / PROGRESSIVE CODE INDEX

INDEX	STRONA PAGE	INDEX	STRONA PAGE	INDEX	STRONA PAGE	INDEX	STRONA PAGE
8377	582	8684	442	8714	436	8774	346
8378	582	8685	442	8715	436	8775	346
8381	143	8686	442	8716	436	8776	346
8382	459	8687	443	8717	436	8777	346
8383	459	8688	443	8720	348	8778	346
8384	463	8690	442	8722	348	8780	346
8385	463	8691	442	8724	333	8781	346
8397	555	8692	440	8727	333	8782	346
8398	555	8693	440	8731	333	8794	145
8430	214	8694	440	8732	333	8795	528
8431	63	8695	440	8738	332	8796	63
8432	63	8696	437	8740	332	8797	63
8433	63	8697	437	8741	332	8798	63
8434	63	8698	439	8742	332	8800	96
8435	63	8700	439	8743	332	8802	177
8436	63	8701	439	8747	430	8805	463
8447	580	8702	439	8752	429	8816	104
8671	126	8703	439	8756	428	8817	104
8672	126	8704	439	8757	428	8818	104
8673	126	8705	438	8762	427	8819	105
8676	443	8706	438	8763	426	8820	105
8677	443	8707	438	8764	426	8821	587
8678	443	8708	438	8765	426	8823	453
8680	443	8710	439	8766	426	8824	455
8681	443	8711	439	8767	349	8825	455
8682	443	8712	438	8772	349	8826	353
8683	442	8713	438	8773	349	8834	463

INDEKS LAMP / PROGRESSIVE CODE INDEX

INDEX	STRONA PAGE	INDEX	STRONA PAGE	INDEX	STRONA PAGE	INDEX	STRONA PAGE
8835	463	8926	337	8967	463	9015	460
8836	463	8928	337	8968	463	9018	453
8837	463	8930	337	8970	463	9021	295
8845	587	8931	337	8971	463	9022	295
8846	587	8932	337	8972	462	9023	295
8851	243	8934	103	8973	462	9024	295
8858	242	8935	103	8974	463	9025	295
8864	243	8937	352	8975	463	9026	295
8895	336	8938	352	8991	486	9028	214
8896	336	8940	352	8992	486	9033	214
8898	336	8942	182	8993	299	9045	282
8900	336	8943	182	8994	299	9046	282
8901	336	8944	182	8995	448	9047	282
8911	101	8945	176	8996	448	9054	65
8912	101	8946	178	8997	448	9056	142
8913	101	8947	178	8998	448	9057	142
8914	96	8950	177	9000	448	9058	142
8915	98	8952	176	9001	448	9060	142
8916	98	8953	178	9002	448	9067	103
8917	98	8954	179	9003	448	9068	103
8918	60	8955	177	9004	449	9070	103
8920	60	8957	179	9005	449	9071	196
8921	60	8958	176	9006	449	9072	196
8922	60	8960	178	9007	449	9084	190
8923	60	8962	179	9012	460	9091	190
8924	60	8965	502	9013	460	9097	525
8925	337	8966	502	9014	460	9100	566

INDEKS LAMP / PROGRESSIVE CODE INDEX

INDEX	STRONA PAGE	INDEX	STRONA PAGE	INDEX	STRONA PAGE	INDEX	STRONA PAGE
9101	566	9153	143	9263	226	9403	350
9102	565	9154	143	9264	226	9404	350
9103	565	9155	143	9266	227	9407	350
9104	568	9158	525	9316	323	9408	350
9105	568	9173	580	9317	299	9412	350
9106	568	9177	582	9320	299	9413	350
9107	545	9178	581	9321	454	9416	350
9108	545	9180	581	9322	454	9417	350
9111	545	9185	518	9324	452	9420	529
9112	539	9186	459	9325	452	9426	503
9113	539	9187	459	9337	453	9448	456
9118	517	9188	459	9338	453	9450	456
9120	517	9190	459	9342	583	9451	456
9122	547	9192	112	9343	583	9452	456
9123	540	9197	580	9344	583	9453	459
9124	540	9211	583	9345	583	9454	459
9125	529	9212	583	9362	144	9455	459
9126	286	9213	583	9363	144	9456	459
9131	147	9214	583	9364	145	9457	459
9132	147	9237	457	9377	228	9458	459
9138	281	9238	457	9378	353	9460	457
9140	281	9240	323	9381	283	9461	457
9142	285	9241	323	9382	283	9462	458
9145	284	9244	452	9383	323	9463	458
9150	287	9245	452	9384	322	9482	339
9151	287	9252	529	9385	322	9486	339
9152	143	9261	227	9387	322	9490	317

INDEKS LAMP / PROGRESSIVE CODE INDEX

INDEX	STRONA PAGE	INDEX	STRONA PAGE	INDEX	STRONA PAGE	INDEX	STRONA PAGE
9491	317	9673	183	10042	329	10144	401
9501	477	9675	112	10043	329	10145	403
9505	475	9677	112	10045	329	10146	408
9507	516	9680	112	10046	329	10147	406
9508	516	9682	185	10047	325	10148	404
9513	556	9687	185	10048	324	10150	400
9514	556	9700	228	10050	324	10151	402
9516	541	9705	269	10051	325	10152	410
9517	541	9706	269	10052	324	10153	410
9518	541	9707	269	10053	324	10154	411
9551	540	9708	269	10054	325	10155	411
9554	569	9710	269	10055	324	10156	420
9555	521	9711	500	10056	324	10157	420
9557	521	9712	500	10057	325	10158	423
9561	520	9713	500	10058	324	10160	423
9562	520	9714	498	10060	324	10161	418
9563	520	9715	499	10062	326	10161	422
9564	545	9736	197	10063	326	10162	416
9565	545	9737	197	10064	326	10163	416
9570	351	9743	280	10065	326	10164	419
9571	351	9744	280	10067	330	10165	419
9574	351	9751	499	10068	330	10166	419
9575	351	9890	284	10070	330	10166	422
9605	184	10035	575	10071	330	10167	419
9606	184	10037	575	10105	503	10167	422
9607	499	10038	575	10142	407	10168	419
9672	183	10040	575	10143	405	10168	422

INDEKS LAMP / PROGRESSIVE CODE INDEX

INDEX	STRONA PAGE	INDEX	STRONA PAGE	INDEX	STRONA PAGE	INDEX	STRONA PAGE
10170	417	10278	271	10312	44	10374	447
10171	419	10280	216	10313	42	10375	447
10171	422	10281	216	10314	45	10376	446
10175	316	10282	216	10315	273	10377	446
10176	316	10283	528	10316	273	10378	447
10177	316	10284	54	10317	273	10380	447
10184	316	10285	54	10347	273	10381	446
10185	316	10286	54	10348	273	10382	446
10186	316	10287	54	10350	273	10383	447
10208	306	10288	54	10351	273	10384	447
10210	306	10289	54	10352	273	10385	446
10212	306	10290	54	10353	273	10386	446
10213	307	10291	54	10354	113	10387	447
10214	307	10292	54	10355	113	10388	447
10225	458	10296	291	10356	219	10390	432
10226	458	10299	122	10358	454	10391	432
10227	462	10300	122	10362	35	10393	432
10228	462	10301	122	10363	40	10394	432
10230	581	10302	121	10364	41	10395	433
10231	581	10303	116	10365	41	10396	432
10235	435	10304	116	10366	48	10397	432
10236	435	10305	116	10367	48	10398	433
10237	435	10306	121	10368	51	10399	432
10238	435	10307	121	10370	51	10400	432
10239	435	10308	121	10371	51	10401	433
10276	271	10310	121	10372	446	10402	313
10277	271	10311	42	10373	446	10403	313

INDEKS LAMP / PROGRESSIVE CODE INDEX

INDEX	STRONA PAGE	INDEX	STRONA PAGE	INDEX	STRONA PAGE	INDEX	STRONA PAGE
10404	313	10448	62	10492	341	10547	345
10406	313	10450	62	10493	340	10548	345
10407	313	10451	62	10494	340	10550	345
10408	313	10452	62	10495	571	10551	345
10410	313	10453	62	10496	571	10552	345
10411	313	10455	269	10497	571	10553	345
10412	313	10456	269	10498	571	10554	345
10413	313	10457	269	10499	570	10555	345
10415	313	10460	92	10500	570	10556	345
10416	313	10463	92	10501	570	10557	345
10417	313	10465	92	10502	570	10558	345
10418	313	10468	92	10503	538	10562	67
10420	314	10476	340	10504	538	10563	67
10421	314	10477	340	10525	466	10564	67
10422	314	10478	340	10526	467	10570	222
10423	314	10480	340	10527	467	10571	222
10424	314	10481	481	10535	344	10572	222
10426	314	10482	481	10536	344	10573	222
10427	314	10483	481	10537	344	10574	222
10428	314	10484	481	10538	344	10575	222
10430	314	10485	341	10540	344	10576	209
10431	314	10486	341	10541	344	10577	209
10432	314	10487	341	10542	344	10578	209
10444	62	10488	341	10543	344	10579	496
10445	62	10489	340	10544	344	10580	496
10446	62	10490	340	10545	344	10581	496
10447	62	10491	341	10546	345	10587	585

INDEKS LAMP / PROGRESSIVE CODE INDEX

INDEX	STRONA PAGE	INDEX	STRONA PAGE	INDEX	STRONA PAGE	INDEX	STRONA PAGE
10588	585	10656	407	10703	292	10746	74
10589	585	10665	491	10704	60	10747	74
10593	584	10666	491	10705	60	10748	74
10594	584	10667	491	10711	487	10752	74
10595	584	10668	491	10712	487	10753	74
10596	584	10670	491	10713	478	10754	74
10597	417	10671	491	10714	478	10758	75
10618	291	10672	491	10715	478	10759	75
10620	51	10673	491	10716	478	10760	75
10621	51	10674	491	10717	480	10764	73
10622	51	10676	491	10718	480	10765	73
10623	121	10677	491	10719	480	10766	73
10633	528	10678	491	10720	480	10770	73
10637	265	10680	491	10723	469	10771	73
10638	265	10681	491	10724	469	10772	73
10643	400	10682	491	10725	469	10776	81
10644	401	10683	491	10726	469	10777	81
10645	402	10684	491	10727	469	10778	81
10646	403	10685	491	10728	469	10779	81
10647	410	10686	544	10729	479	10780	81
10648	410	10687	544	10730	479	10781	81
10650	404	10688	544	10734	72	10782	81
10651	405	10695	293	10735	72	10783	81
10652	408	10696	293	10737	76	10784	81
10653	411	10700	293	10739	76	10785	81
10654	411	10701	293	10741	77	10786	81
10655	406	10702	292	10743	77	10788	343

INDEKS LAMP / PROGRESSIVE CODE INDEX

INDEX	STRONA PAGE	INDEX	STRONA PAGE	INDEX	STRONA PAGE	INDEX	STRONA PAGE
10789	343	10817	26	10863	24	10898	72
10790	343	10820	72	10864	25	10899	72
10791	343	10821	72	10865	29	10900	73
10792	343	10822	72	10866	27	10901	73
10793	343	10823	72	10867	26	10902	73
10794	343	10824	72	10872	253	10903	73
10795	93	10825	72	10873	253	10905	261
10796	93	10840	342	10878	253	10906	261
10797	93	10841	342	10879	253	10907	64
10798	93	10842	342	10880	252	10910	64
10799	93	10843	342	10881	252	10913	64
10800	93	10844	342	10882	72	10915	64
10801	93	10845	342	10883	72	10928	29
10802	93	10847	40	10884	72	10930	29
10803	93	10848	41	10885	72	10933	580
10804	93	10850	41	10886	72	10934	117
10805	93	10851	42	10887	72	10971	492
10806	93	10852	42	10888	74	10972	492
10807	93	10853	44	10889	74	10973	492
10808	29	10854	45	10890	74	10974	492
10810	32	10855	48	10891	74	10975	492
10811	32	10856	48	10892	75	10976	492
10812	24	10857	35	10893	75	10977	492
10813	24	10858	29	10894	72	10978	492
10814	25	10860	32	10895	72	10979	492
10815	29	10861	32	10896	72	10980	492
10816	27	10862	24	10897	72	10981	492

INDEKS LAMP / PROGRESSIVE CODE INDEX

INDEX	STRONA PAGE	INDEX	STRONA PAGE	INDEX	STRONA PAGE	INDEX	STRONA PAGE
10982	492	11161	231	11210	310	11301	588
10983	493	11162	231	11211	310	11305	383
10984	493	11163	234	11212	310	11306	382
10985	493	11164	234	11225	258	11307	385
10986	493	11165	234	11226	258	11308	384
10987	493	11166	234	11227	258	11310	389
10988	493	11167	234	11228	258	11311	388
10989	493	11168	234	11230	258	11312	387
10990	493	11170	232	11231	258	11313	386
10991	493	11171	232	11232	258	11314	390
10992	493	11172	232	11233	258	11315	391
10993	493	11173	205	11242	240	11316	392
10994	493	11174	205	11243	240	11317	393
10995	581	11175	202	11244	241	11318	395
10996	581	11176	202	11245	241	11320	395
10997	581	11177	203	11251	241	11321	397
10998	581	11178	212	11252	241	11322	397
11150	235	11180	203	11278	588	11325	397
11151	235	11200	310	11287	588	11326	397
11152	235	11201	310	11288	212	11327	397
11153	230	11202	310	11290	212	11328	397
11154	230	11203	310	11291	212	11330	397
11155	230	11204	310	11292	212	11331	383
11156	236	11205	310	11295	434	11332	382
11157	236	11206	310	11296	434	11333	385
11158	237	11207	310	11297	452	11334	384
11160	231	11208	310	11298	455	11335	389

INDEKS LAMP / PROGRESSIVE CODE INDEX

INDEX	STRONA PAGE	INDEX	STRONA PAGE	INDEX	STRONA PAGE	INDEX	STRONA PAGE
11336	388	11375	510	11434	76	11466	76
11337	387	11376	512	11435	77	11467	76
11338	386	11377	560	11436	77	11468	77
11340	390	11378	44	11437	76	11470	77
11341	391	11380	44	11438	76	11471	70
11342	392	11381	45	11440	77	11472	71
11343	393	11382	45	11441	77	11473	76
11346	548	11395	233	11442	76	11482	253
11347	548	11396	233	11443	76	11483	253
11348	341	11397	233	11444	76	11484	253
11350	341	11398	26	11445	70	11485	253
11357	308	11400	41	11446	71	11486	253
11358	308	11401	32	11447	70	11487	253
11360	558	11402	29	11448	71	11488	252
11361	558	11403	24	11450	70	11490	252
11362	558	11408	120	11451	71	11491	252
11363	537	11410	246	11452	252	11492	252
11364	537	11411	246	11453	252	11493	252
11365	537	11412	246	11454	252	11494	241
11366	537	11413	246	11455	252	11495	241
11367	557	11414	246	11456	252	11496	240
11368	530	11425	46	11460	58	11510	248
11370	530	11426	46	11461	58	11511	248
11371	511	11427	589	11462	59	11512	248
11372	511	11431	49	11463	59	11513	248
11373	511	11432	210	11464	59	11520	199
11374	510	11433	76	11465	59	11521	199

INDEKS LAMP / PROGRESSIVE CODE INDEX

INDEX	STRONA PAGE	INDEX	STRONA PAGE	INDEX	STRONA PAGE	INDEX	STRONA PAGE
11525	582	11557	533	11591	44	11632	401
11528	561	11558	533	11592	44	11633	401
11530	561	11560	533	11601	29	11634	403
11531	552	11561	533	11602	26	11635	403
11532	552	11562	535	11603	29	11636	404
11533	552	11563	535	11604	24	11637	404
11534	552	11564	535	11605	32	11638	405
11535	552	11565	535	11606	35	11639	405
11536	554	11566	535	11607	35	11640	408
11537	554	11567	535	11616	418	11641	408
11538	509	11568	535	11616	422	11642	406
11540	513	11570	535	11617	419	11643	406
11541	508	11571	535	11617	422	11644	407
11542	508	11572	535	11618	419	11645	407
11543	567	11573	535	11620	419	11646	25
11544	507	11574	535	11621	419	11647	25
11545	507	11578	46	11621	422	11648	26
11546	507	11580	46	11622	423	11649	26
11547	519	11581	41	11623	423	11650	150
11548	531	11582	41	11624	420	11651	150
11550	531	11583	40	11625	420	11652	151
11551	531	11584	40	11626	416	11653	151
11552	531	11585	51	11627	416	11654	152
11553	532	11586	51	11628	419	11655	152
11554	532	11587	51	11628	422	11656	153
11555	533	11588	45	11630	400	11657	154
11556	533	11590	45	11631	400	11658	154

INDEKS LAMP / PROGRESSIVE CODE INDEX

INDEX	STRONA PAGE	INDEX	STRONA PAGE	INDEX	STRONA PAGE	INDEX	STRONA PAGE
11659	155	11700	139	11731	376	11784	193
11660	155	11701	138	11732	378	11785	192
11661	156	11702	138	11733	378	11786	194
11662	156	11703	139	11734	375	11787	193
11663	157	11704	138	11734	378	11788	192
11664	160	11705	130	11735	375	11790	194
11665	160	11706	130	11735	378	11791	194
11666	160	11707	131	11736	375	11792	193
11667	163	11708	131	11736	378	11793	192
11668	162	11712	366	11737	372	11794	589
11669	162	11713	368	11738	373	11795	589
11670	161	11714	368	11740	373	11796	589
11671	161	11715	369	11743	363	11797	589
11672	161	11716	369	11744	373	11798	589
11673	166	11717	364	11746	141	11800	589
11674	166	11718	361	11747	141	11801	589
11675	166	11720	360	11748	141	11802	589
11676	169	11721	362	11750	141	11803	417
11677	168	11722	367	11763	74	11804	547
11678	168	11723	365	11764	74	11805	547
11679	167	11724	372	11765	74	11812	66
11680	167	11725	372	11766	74	11813	66
11681	167	11726	375	11778	194	11814	66
11682	171	11726	379	11780	193	11815	66
11683	171	11727	375	11781	192	11874	588
11684	171	11728	375	11782	194	11875	588
11699	139	11730	376	11783	194	11876	275



INDEKS LAMP / PROGRESSIVE CODE INDEX

INDEX	STRONA PAGE	INDEX	STRONA PAGE	INDEX	STRONA PAGE	INDEX	STRONA PAGE
11877	275	11883	275	11887	37	11894	379
11878	275	11884	275	11888	37		
11879	34	11885	34	11893	375		
11882	275	11886	37	11894	375		



Nowodvorski
LIGHTING

 Nowodvorski Lighting sp. z o.o.
ul. Bojemskiego 11
42-202 Czestochowa
POLAND

 +48 34 344 91 10 / 11
 nowodvorski@nowodvorski.com
 www.nowodvorski.com





www.nowodvorski.com